

Deltek Open Plan™ 3.3

User Guide

December 19, 2008



13880 Dulles Corner Lane
Herndon VA 20171
TEL: 703.734.8606
FAX: 703.734.1146

While Deltek has attempted to verify that the information in this document is accurate and complete, some typographical or technical errors may exist. The recipient of this document is solely responsible for all decisions relating to or use of the information provided herein.

The information contained in this publication is effective as of the publication date below and is subject to change without notice.

This publication contains proprietary information that is protected by copyright. All rights are reserved. No part of this document may be reproduced or transmitted in any form or by any means, electronic or mechanical, or translated into another language, without the prior written consent of Deltek, Inc.

This edition published December 2008.

© 2008 Deltek, Inc.

Deltek's software is also protected by copyright law and constitutes valuable confidential and proprietary information of Deltek, Inc. and its licensors. The Deltek software, and all related documentation, is provided for use only in accordance with the terms of the license agreement. Unauthorized reproduction or distribution of the program or any portion thereof could result in severe civil or criminal penalties.

All trademarks are the property of their respective owners.

Contents

Introduction	1
Using this Manual.....	3
The Open Plan Migration Utility	4
Working with Open Plan Data	5
Chapter Summaries	6
Symbols Used Throughout the Manual.....	8
Welcome to Deltek Open Plan	9
Overview	11
Open Plan Professional and Open Plan Desktop.....	12
The Deltek Applications Program Group	14
Starting Open Plan.....	15
Logging into Open Plan	15
Using the Help System.....	17
Displaying System Information	19
Exiting Open Plan	20
Where to Go from Here.....	21
Basic Skills	23
Overview	25
Choosing Commands.....	26
Using the Menu Bar	26
Using the Toolbar	27
Customizing Add-Ins Toolbars	29
Using the Right Mouse Button.....	31
Using Keyboard Shortcuts.....	33
Working with Windows	33
Working with Dialog Boxes	35
Using Tabbed Dialog Boxes	36
Using Modeless Dialog Boxes.....	36
Using Edit Boxes.....	38
Using the Mouse	39
Selecting Data.....	40
Cutting, Copying, and Pasting Data.....	43
Getting Started	47
Overview	49

Describing the Open Plan Explorer.....	50
The Hierarchical Pane.....	51
My Folder.....	51
Projects.....	52
Open Plan Library.....	52
Briefcase.....	52
Users	52
Startup	54
The Contents Pane	55
Customizing the Details Format Display	55
Using the Open Plan Explorer	60
Opening a Project or Auxiliary File	60
Creating a New Project or Auxiliary File.....	62
Saving Files	63
Closing Files	65
Assigning Auxiliary Files to a Project	66
Assigning Views to a Project	68
Creating a Shortcut.....	69
Deleting Files.....	70
Filtering the Contents of the Display Format.....	71
Using Find.....	73
Creating a New File.....	77
Overview	79
Creating a File with Default Settings.....	80
Creating a File with Custom Settings.....	81
Using the New File Wizard.....	84
New File Wizard — Create Page.....	84
New File Wizard — Summary Page	86
New File Wizard — Status Information	87
New File Wizard — Files Page.....	88
New File Wizard — External Subprojects	92
New File Wizard — Preferences	93
New File Wizard — Code Structure	95
New File Wizard — Notes	97
New File Wizard — Access Control	98
File Properties	101
Overview	103

Auxiliary File and View Properties Tabs	104
Editing Considerations.....	104
The General Tab	105
The Statistics Tab.....	107
The Files Tab.....	108
The Access Control Tab.....	109
The Open Status Tab	110
The References Tab.....	110
The Notes Tab.....	111
The User Fields Tab	112
The Structure Tab.....	113
The Preferences Tab.....	114
Project Properties Tabs.....	115
The Summary Tab.....	116
The Preferences Tab.....	118
The Files Tab.....	121
The Status Tab	122
The Cost Tab.....	123
The Notes Tab.....	125
The Scheduling Tab	126
The User Fields Tab	128
The Access Control Tab.....	128
The Open Status Tab	129
The References Tab.....	130
The Codes Tab.....	131
Activity Information	133
Overview	135
Guidelines for Planning Activities.....	136
The Activity Details Dialog Box	137
The General Tab	138
Using Automatic Numbering.....	140
The User Fields Tab	142
Entering Activity Relationships.....	143
The Relationships Tab.....	143
The Add Relationship Dialog Box.....	145
Loop Detection	145
Using Barchart Views.....	146

The Barchart Pane	146
The Bar Data Mode and the Relationship Mode	147
The Spreadsheet Pane.....	149
Using Network Views	153
Using Spreadsheet Views	155
Utilities.....	158
Finding an Activity	158
Displaying Activity Information.....	159
Finding a Date	161
Deleting an Activity	162
Setting Column and Row Attributes for a View	163
Resource Definitions	167
Overview	169
Resources in Open Plan	170
Resource Files	171
Defining Resources.....	174
General Resource Information	175
Resource Codes.....	179
Resource Availabilities	180
Consumable and Perishable Availabilities	181
Interpreting Zero Availabilities	181
Cost Escalations.....	182
User-Defined Fields.....	182
Resource Notes.....	184
Reserving Resources for Projects	186
Effect of Reservations on the Select Resource Dialog Box	186
Entering Resources.....	188
Automatic Numbering within a Resource View	190
Resource Skills	192
Managing Skills	192
Assigning Skills.....	194
Displaying Resource Information	196
Defining Display Options	196
Customizing Box Layout.....	197
Using the Zoom Out and Zoom In Commands.....	199
Resources in Spreadsheet and Barchart Views	201
Resource Assignments	203

Overview	205
Entering Resource Assignments.....	206
Using the Activity Details Dialog Box	206
Using the Assign Multiple Resources to Multiple Activities Dialog Box	211
Using the Select Resource Dialog Box	212
Using Spreadsheet Views	216
Using Barchart Views	218
Resource Allocation	220
Replacing Requested Resources for an Activity	221
Using Resource Locking.....	222
Effort-Driven Activities.....	225
Defining Assignment Profiles Manually.....	226
Project Calendars	227
Overview	229
Calendar Files	230
Calendars.....	232
The Default Calendar	232
Activity and Relationship Calendars.....	232
Resource Calendars.....	233
Adding Calendars	235
Defining a Standard Workweek.....	236
Entering Calendar Information.....	237
Setting Up a Holiday List	239
Working with Calendars.....	240
Controlling the Display of Calendars	242
Cost Information	245
Overview	247
Earned Value Management	248
Cost and Schedule Variances	249
Planning Costs	251
Setting Up Categories	251
Setting up Resource Rates.....	252
Assigning Resources.....	252
Calculating Costs.....	252
Progress and Cost	255
Entering Physical Percent Complete.....	255

Capturing Actual Costs.....	256
Cost Reporting	261
Project Codes.....	263
Overview	264
Coding Systems in Open Plan	265
Creating Code Files	267
Using Code Files.....	269
The Code Details Dialog Box.....	272
The Code Tab.....	272
The User Fields Tab	273
The Notes Tab.....	274
Entering Codes	275
Displaying Code Information.....	278
Defining Display Options	278
Customizing Box Layout.....	279
Using the Zoom Out and Zoom In Commands.....	281
Entering Code Assignments	283
Project Code Assignments	283
Activity Code Assignments	284
Resource Code Assignments.....	285
Using an Activity Spreadsheet View.....	286
Hierarchical Projects	287
Overview	289
Setting Up Project Hierarchies.....	290
Defining Internal Subprojects	290
Defining External Subprojects	291
Subprojects in Network Views	293
Displaying Project Hierarchies.....	293
Adding Child Activities	295
Moving Activities Between Subprojects.....	295
Subprojects in Spreadsheet Views	297
Indent.....	298
Outdent.....	299
Working with External Subprojects	301
Opening External Subprojects.....	301
External Projects and Auxiliary Data Files	302
Converting External Projects	303

Displaying Foreign Activities.....	303
Reporting Hammocks.....	304
Time Analysis.....	305
Overview	307
What is Time Analysis?.....	308
Early and Late Dates	308
Float Calculations	308
Supplemental Activity Information	309
Subproject Information	310
Project Information	310
Time Analysis Operations	311
Using the Time Analysis Dialog Box	311
Using the Time Analysis Button on the Toolbar	314
Group Process Time Analysis	314
Using Automatic Time Analysis.....	315
Resource Scheduling	317
Overview	319
What is Resource Scheduling?.....	320
Resource Scheduling Methods.....	320
Effect of Reservations on Resource Scheduling.....	320
The Results of Resource Scheduling Calculations	321
Resource Scheduling Rules	321
Resource Scheduling Attributes for Activities	323
Activity Splitting	323
Activity Stretching	323
Activity Reprofileing	324
The Immediate Attribute	325
Assigning Scheduling Attributes to Activities.....	325
Performing Resource Scheduling	328
Using the Resource Scheduling Button on the Toolbar	330
Group Process Resource Scheduling	330
Advanced Resource Scheduling Options	332
In-Progress Priority.....	332
Hard Zeros.....	333
Resource Smoothing	333
Priority Fields.....	334

Scheduling Interval	336
Resource Selection	336
Force Overloaded Activities to Late Dates	337
Try Alternate Resource to Avoid Delay	337
Limit Reprofitting to Original Level.....	337
Using Resource Scheduling Information.....	338
Reporting on Resource Scheduling	340
Risk Analysis	343
Overview	345
Defining Activity Risk.....	346
Risk Analysis Operations	349
Using the Risk Analysis Dialog Box	349
Using the Risk Analysis Button on the Toolbar	351
Group Processing Risk Analysis	352
Interpreting the Results of Risk Analysis	353
Risk Histograms	355
Status Information	357
Overview	359
Project Baselines	360
Creating a Baseline	360
Defining Access Rights to a Baseline.....	364
Managing Baselines	366
Using Baseline Information.....	367
Activity Progress	369
Entering Activity Progress	369
Entering Progress in a Spreadsheet View.....	371
Entering Progress in a Barchart View	372
Viewing Project Progress Information	372
The Effect of Activity Progress Information	373
Resource and Cost Progress.....	375
Calculating Activity Progress Automatically.....	379
Calculating Resource Progress Automatically.....	383
Calculating Earned Value Progress Automatically	386
Progress Dates	388
Views and Reports.....	389
Overview	391

Views.....	392
Working with Views	392
Browser Views.....	394
Custom Symbols.....	399
Using the Add Symbol Dialog Box	400
Using the Edit Symbol Dialog Box.....	401
Printing Reports	402
Using the Print Command	402
Using the Print Setup Command.....	403
General Print Options	404
Print Options for Barcharts and Histograms.....	406
Using the Date Range Options Dialog Box	408
Defining Title Blocks	410
Previewing a Report	413
Reporting Calendars	415
Assigning a Reporting Calendar.....	417
Notes.....	418
Using Note Categories	419
Including Notes in Reports	421
Barchart Views.....	423
Overview	425
Customizing the Date Scale.....	426
Defining a Date Scale Manually	427
Defining a Date Scale Using Autoscaling.....	430
Using Reporting Calendars	432
Adjusting the Date Scale with a Mouse.....	433
Barchart Display Options	435
Multi-Table Barcharts.....	437
Network Views.....	439
Overview	441
Controlling Box Sizes.....	442
Network Legends	443
Annotations	445
Displaying Subprojects.....	448
Displaying Multiple Subprojects.....	450
Automatic Placements	453

Defining Custom Zoning	456
Defining Time Scaling.....	458
Using the Zoom Commands	460
Network Display Options.....	462
Splitting the Network View	464
Spreadsheet Views	467
Overview	469
Customizing Spreadsheet Columns.....	470
Using the Fill Column Down Command	473
Splitting the Spreadsheet View.....	474
Spreadsheet Display Options	475
Support for All Tables.....	477
Subsections.....	479
Defining Subsections	481
Outlining	484
Defining Outlining	485
Linking	488
Defining Links	488
Modifying Hierarchal IDs Using Indent and Outdent.....	491
Automatic Numbering within a Spreadsheet.....	492
Histogram Views	493
Overview	495
Working with Resource Histograms.....	496
Displaying Resource Information	499
Displaying Earned Value Information.....	503
Customizing Resource Histogram Views.....	506
Selecting Resources.....	506
Resource Histogram Display Options	508
Customizing the Date Scale	510
Working with Risk Histograms	511
Customizing Risk Histogram Views	513
Selecting a Key Activity	513
Risk Histogram Display Options.....	513
Customizing the Date Scale	514
Importing and Exporting Files	515
Overview	517

Microsoft Project	518
System Requirements	518
Importing Microsoft Project Data	518
Exporting Microsoft Project Data	521
The Select MSP Version Dialog Box	524
Primavera Project Planner	526
Importing Primavera Files.....	526
Exporting Primavera Files	526
Custom Import/Export Operations	528
Import General.....	528
Export General	529
Crosstable Exports	530
Project Utilities.....	541
Overview	543
Filters.....	544
Using Filters.....	544
Defining Filter Expressions.....	546
Additional Filtering Options.....	549
Temporary Filters	550
Temporary Filters on a Secondary Table	551
Sorts.....	553
Default Sort Order Rules	553
Using Sorts	554
Defining Custom Sorts.....	555
Temporary Sorts.....	557
Temporary Sort on a Secondary Table	559
Click to Sort	560
Calculated Fields.....	561
Defining Calculated Fields.....	561
Temporary Calculated Fields.....	564
Rollup	566
Group Process Rollups.....	568
Global Edit.....	569
Defining Global Edits	570
Batch Global Edits	574
User Defined Fields.....	576
Creating a User Defined Field	577

Copying a User Defined Field.....	578
Editing a User Defined Field.....	579
Deleting a User Defined Field.....	579
Spread Curves	580
System Utilities	583
Overview	585
Custom Tools	586
Email Advisor	587
File Management	593
Deleting a File.....	593
Backing Up a File	594
Restoring a File	595
Briefcasing a File	600
Changing the Access Mode.....	603
Change Ownership and Access Rights.....	604
Group Delete.....	608
Open Plan Log Viewer	609
Managing the Data Source	614
Editing a Data Source.....	615
Security	616
Defining Access Rights.....	616
Changing Your User Password	617
Security Administrator	618
User Notification in Open Plan.....	620
Sending Project Information Via Email	621
Shortcut Properties	622
Spell Checker.....	624
Web Publisher.....	626
Creating a Report Batch.....	627
Defining Output Options	630
Working in a Multi-User Environment	631
Opening Files.....	631
Working in the Exclusive Mode	632
Working in the Shared Mode	632
Working in the Read Only Mode	633
Setting the Default Access Mode	633
System Defaults	637

Overview	639
System Options	640
General Tab	640
Edit Tab	642
Project Tab	643
Views Tab	644
Codes Tab	646
Color Tab	647
Email Tab	648
Advanced Tab	650
Appendix A - Glossary	661
Appendix B - Keyboard Shortcuts.....	679
Index	681

Introduction

➤ Using this Manual.....	3
➤ The Open Plan Migration Utility	4
➤ Working with Open Plan Data.....	5
➤ Chapter Summaries	6
➤ Symbols Used Throughout the Manual.....	8

Using this Manual

Welcome to the *Deltek® Open Plan™ User's Guide*. Open Plan is an enterprise project management system that substantially improves your organization's ability to complete multiple projects on time and on budget. With multi-project analysis, critical path planning and resource management, Open Plan offers the power and flexibility to serve the differing needs of business, resource, and project managers.

This document uses Adobe™ Reader™ to display the *Deltek Open Plan User's Guide*. To learn the various features of Acrobat Reader, consult the Reader online help system.

The Open Plan Migration Utility

Because the manner in which Open Plan 3.x stores its data is different from the way in which it was stored in previous versions, you cannot use an Open Plan 2.x project directly in Open Plan 3.x. The **Deltek Open Plan Migration Utility** allows you to migrate your Open Plan 2.6 or 2.5 data into the format required by Open Plan 3.0 and store it in an Open Plan 3.x data source.

This new way of storing your data offers much improved flexibility. Because Open Plan 3.x stores all data in a central data source, you can always access your data from multiple locations within your organization.

The **Migration Utility** is designed to migrate not only your Open Plan 2.6 or 2.5 projects, but also their named objects: auxiliary files, views, filters, sorts, calculated fields, global edits, and email advisories.



The **Migration Utility** does not work with Open Plan data prior to 2.5. If you need to migrate this data to Open Plan 3.x, you must first open it in Open Plan 2.5 or 2.6 and resave it with a new name using the **Save As** command.

Since the **Migration Utility** works with a copy of your data, your original data remains in its current location. However, as with all operations that deal with your valuable data, you should always create a complete backup before proceeding.



For information on migrating your data, refer to the *Deltek Open Plan Data Migration Utility* documentation.

Working with Open Plan Data

In Open Plan 3.x, data is stored in an SQL data repository. Because all the data and most configuration information are stored in the database, you can log into Open Plan from any terminal on your network and have the same environment that you have on your own computer.

In the strictest sense of the word, Open Plan data is stored in tables in the data source rather than in files. However, in order to make explanations of the software easier to understand, dialog boxes, menus, and the Open Plan documentation refer to Open Plan data as “files.” This allows us to describe such operations as opening a file, saving a file, etc.

Chapter Summaries

Chapter 1 discusses the Professional and Desktop editions of Open Plan and covers the basics of getting started with the program. It concludes with a discussion on the types of documentation supplied with Open Plan.

Chapter 2 discusses the basic skills common to many Windows applications (such as selecting commands, working with dialog boxes, and using the mouse) as well as how to cut, copy, and paste.

Chapter 3 describes the Open Plan Explorer interface and discusses how to manage your project data using the commands available in the Open Plan Explorer.

Chapter 4 discusses how to create new files using Open Plan default settings and using custom settings. The chapter concludes with a detailed description of each page of the **New File Wizard**.

Chapter 5 begins with a discussion of the **Properties** dialog box for auxiliary (resource, code, and calendar) files and view files and concludes with a discussion of the **Project Properties** dialog box.

Chapter 6 outlines guidelines for planning activities and describes the types of information you can enter in Open Plan for activities and relationships. The chapter also includes procedures for entering activity and relationship information and concludes with discussions of a number of utilities related to activity information.

Chapter 7 contains discussions on defining resources in Open Plan, including such topics as creating a resource file, reserving resources for projects, and displaying resource information.

Chapter 8 begins with a description of the different methods you can use to enter resource assignments. This is followed by a section on resource allocation and concludes with sections on effort-driven activities and defining assignment profiles manually.

Chapter 9 starts with a discussion on calendars in Open Plan and ends with discussions on creating and maintaining calendars.

Chapter 10 begins with a brief discussion of basic cost control and earned value concepts. It concludes with discussions on planning costs, capturing actual costs, and reporting on costs.

Chapter 11 discusses working with project code files, entering codes, displaying code information, and entering code assignments

Chapter 12 discusses a number of issues related to project hierarchies in Open Plan, including setting up a project hierarchy and working with hierarchical projects in different views. It concludes with a discussion of reporting hammers, a traditional feature for rolling up project information.

Chapter 13 begins with a brief introduction to time analysis features followed by a description of how to perform time analysis in Open Plan.

Chapter 14 begins with a brief introduction to resource scheduling in Open Plan, followed by a description of the different scheduling attributes available for activities. The chapter continues with a description of how to perform resource scheduling in Open Plan, including information about advanced resource scheduling options. It concludes with discussions on using resource scheduling information and reporting resource scheduling results.

Chapter 15 provides discussions on risk analysis in Open Plan and how to perform it. The chapter ends with discussions on interpreting the results of risk analysis and displaying the results in a risk histogram.

Chapter 16 starts with discussions on creating and managing project baselines. It provides discussions on entering activity and resource progress information and how Open Plan uses progress information when calculating schedules. The chapter concludes with a discussion of the automatic progressing features in Open Plan.

Chapter 17 discusses a number of topics related to the reporting of project data in Open Plan, including working with views, using custom symbols, printing reports, and assigning reporting calendars. It concludes with a discussion of the notes feature in Open Plan.

Chapter 18 discusses customizing the bar display portion of a barchart view.

Chapter 19 discusses how to customize a network view.

Chapter 20 discusses each of the ways you can customize a stand-alone spreadsheet view and the spreadsheet portion of barchart views.

Chapter 21 starts with a general discussion of resource histogram views in Open Plan, followed by a description of the types of resource and earned value information that can appear in a histogram view. Next is a description of how to customize a resource histogram. The chapter concludes with a discussion of the features related to risk histograms.

Chapter 22 discusses the import and export utilities for Microsoft Project and Primavera Project Planner as well as customized importing and exporting using user-defined scripts.

Chapter 23 discusses a number of project-level utilities that facilitate the manipulation of project data. These include filters, sorts, calculated fields, global edits, user defined fields, and spread curves.

Chapter 24 discusses each of the system utilities provided by Open Plan and concludes with a discussion of working with project data in a multi-user environment.

Chapter 25 discusses how to modify the system options defaults using the different tabs of the **Options** dialog box.

Appendix A is a glossary of terms used throughout the *Deltek Open Plan User's Guide*.

Appendix B contains a list of keyboard shortcuts.

Symbols Used Throughout the Manual

The following are descriptions of the various icons you will encounter throughout this manual:



This icon identifies a Note. This is additional information about the subject being discussed.



This icon refers you to other sections of the user guide for additional information about the subject being discussed.



This icon gives a precaution or warning.

1

Welcome to Deltek Open Plan

➤ Overview	11
➤ Open Plan Professional and Open Plan Desktop	12
➤ The Deltek Applications Program Group	14
➤ Starting Open Plan.....	15
➤ Using the Help System.....	17
➤ Displaying System Information	19
➤ Exiting Open Plan	20
➤ Where to Go from Here.....	21

Overview

Welcome to Open Plan, your comprehensive solution to project planning and management tasks.

Designed to cope with the most demanding requirements of project planners, Open Plan has the capability, the flexibility, and the processing muscle to handle the largest projects. At the same time, Open Plan takes advantage of the latest advances in OLE automation and graphical interface design to make its power accessible to the most inexperienced user.

This chapter begins with a discussion of the Professional and Desktop editions of Open Plan and then covers the basics of getting started in Open Plan — the Deltek Applications program group, starting the application, and getting help information. The chapter concludes with a discussion of the various types of documentation supplied with Open Plan.

Open Plan Professional and Open Plan Desktop

The Open Plan family of project management products is designed to provide a set of comprehensive solutions to real-world problems facing corporate project managers. Even in organizations with a strong commitment to modern project management techniques, there are often only a relative handful of skilled planners and schedulers who are charged with tracking the vast amounts of data that can be generated in the course of a typical large-scale project. These members of the project team have the overall view necessary to design and maintain the planning, implementation, and reporting systems that characterize successful project management. They understand how they can take advantage of the power and flexibility of high-end project management software packages. In most cases, however, these planners are too far removed from the day-to-day activities of the project to ensure the consistent implementation of corporate-wide standards and procedures necessary to support those systems.

At the same time, there may be dozens or even hundreds of lower-level managers or group leaders who are familiar with their particular areas of responsibility but need to understand how their part of the puzzle fits into the overall strategy of the organization. These members of the project team typically have the ground-level view necessary for accurate scheduling and planning. Many are eager to apply techniques such as time analysis or resource scheduling to the planning of their own work. Few, however, have the time or the expertise to master all the intricacies of a fully featured project management software package. In some cases, these lower-level managers ultimately adopt less-powerful scheduling tools that can interfere with the consistent collection and distribution of data across the entire project team.

To address this type of problem, Open Plan is made available in two editions: Open Plan Professional and Open Plan Desktop. Designed to work together, the Professional and Desktop editions of Open Plan offer a project management solution that can encompass the needs of both full-time project schedulers and team members for whom scheduling and planning are occasional functions only.

With Open Plan Professional, planners can take advantage of the full range of high-end project management features, including:

- The creation of custom views and reports
- The specification of custom calculations and nonlinear reporting calendars
- The ability to develop multi-project schedules, resource loadings, and reports

Users of Open Plan Desktop, on the other hand, can enjoy a fully featured project management system with the ability to enter, status, and report on project data but without some of the customizing features available in Open Plan Professional. This allows Desktop users full access to the powerful analytical features of Open Plan while reducing the complexity of its operations.

Typically, a planning function within an organization might consist of a small number of Open Plan Professional users and a much larger number of Open Plan Desktop systems. Planners using Open Plan Professional might develop custom views and reports, and calculations, which could then be shared by Open Plan Desktop users. In many cases, standard resource lists, coding systems, work calendars, and even model networks would be developed and disseminated across the entire organization. For their part, Desktop users would provide scheduling and status inputs that could be rolled up to higher-level summaries for management review. A more comprehensive planning and control strategy might include the use of multi-project scheduling and resource loading in which master projects created

by Open Plan Professional users would reflect the dates and requirements of subprojects being planned and maintained at a lower level.

By combining the different strengths of Open Plan Professional and Open Plan Desktop, creative organizations have the strategic and tactical tools to make corporate project management a reality.

The Deltek Applications Program Group

Open Plan comes with an automated setup utility. With this utility, you can perform a complete installation of all the files that come with your Open Plan CD, or you can perform a custom installation that copies only the features you plan to use.



For information about using the setup utility, refer to the *Deltek Open Plan Installation Guide*.

As a part of its installation procedures, Open Plan automatically adds the Deltek Applications folder containing a set of application shortcuts to the Windows Start/Programs menu.

The applications represented in this folder are as follows:

- Open Plan Professional or Open Plan Desktop — The main Open Plan application
- *Deltek Open Plan User's Guide* — The Open Plan user documentation
- *Deltek Open Plan Developer's Guide* — Reference and technical documentation
- Open Plan Help — The Open Plan context-sensitive Help system
- Deltek Security Administrator — The Deltek security management application (Open Plan Professional installations only)
- Deltek Open Plan Migration Utility — A utility to migrate Open Plan 2.6 or 2.5 data into the format required for version 3.x. (Open Plan Professional installations only)
- OLE Setup — Ensures that the correct version of OLE automation is invoked when switching between Open Plan versions 2.0 (16-bit), 2.1 or 2.6 (32-bit), or 3.0
- *Deltek Open Plan Release Notes* — An HTML document that discusses the new features of this release, changes to the documentation, and the Software Fault Report (SFR) resolutions.



Installations of Open Plan Desktop or customized versions of Open Plan Professional may not include all of the available applications.

Starting Open Plan

Once you have used the setup utility to install Open Plan, you can start the application from the Windows Desktop.

 To start Open Plan each time you enter Windows, add the Open Plan application to the Startup menu. For more information about the Startup menu, refer to your Windows documentation.

To start Open Plan

1. On the Windows Desktop, click **Start**, and point to **Programs**.
2. On the **Programs** menu, point to **Deltek Applications**, and click **Open Plan Professional** or **Open Plan Desktop** on the submenu.

Logging into Open Plan

When Open Plan starts it displays the **Open Plan Login** dialog box:



You can use the following controls to log into the active data source for your session of Open Plan:

 The active data source is set up by the system administrator.

- **User ID** — The ID that your system administrator has set up for your use.

 Open Plan remembers the user ID from the last time Open Plan was used and automatically enters that user ID in this field. If this user ID is not the one you wish to use, simply delete it, and enter the proper one.

- **Password** — The password associated with your user ID.
- **Using Briefcasing Data Source** — If you select this option, Open Plan opens your briefcasing data source instead of your main data source.

If, after you click **Login**, Open Plan issues a message that your login information is invalid, reenter your user ID and password, and click **Login** again. If Open Plan still does not start, check with your system administrator. There are several possible causes for this situation, including:

- There may be an interruption of network services.
- You may not be properly registered as a valid user of the active data source.

- You may have entered an incorrect password.

Your system administrator will be able to determine the cause of the problem and take steps to correct it.



You can change the active data source before logging in. To do so, hold down the **Ctrl** key while clicking **Login**. This will display the **Data Sources** dialog box that you can use to select a different data source for this session.

Using the Help System

Online, context-sensitive help is available throughout Open Plan. Each time you display a dialog box, you can display help about that dialog box by clicking **Help** or by pressing **F1**.

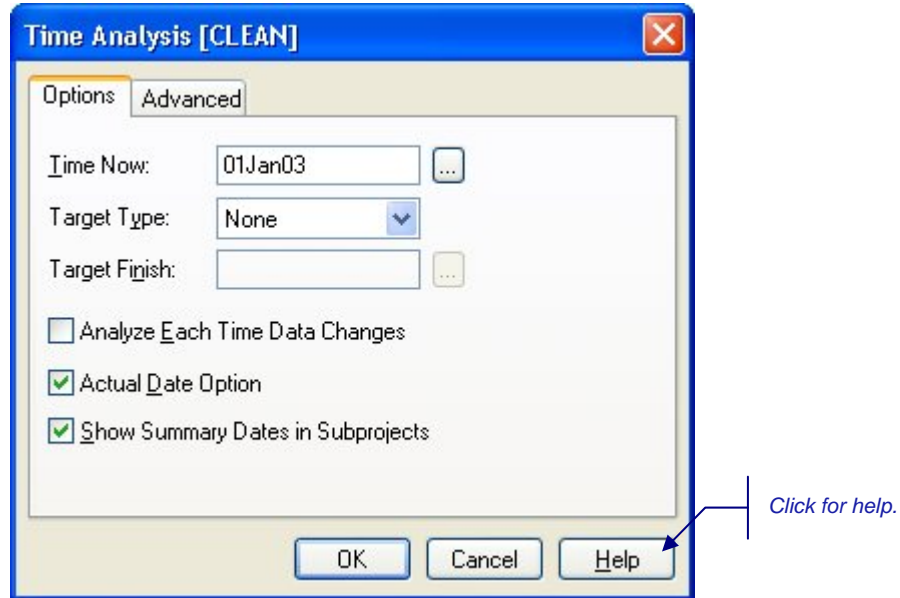

You can also display help for any view or window by pressing **F1**.

To examine a list of topics covered in the help system, click **Contents** on the **Help** menu. From the **Contents** tab of the Help window, you can select a topic by clicking the topic heading.



For a complete description of how to use the help system, click **Using Help** on the **Help** menu.

The Open Plan help system includes a special type of information called Clip Notes. Clip Notes describe how to perform many common procedures in Open Plan and are displayed in special “stay-on-top” windows that allow you to keep working in the application.

The screenshot shows the Open Plan Professional interface. The main window displays an 'Activity Spreadsheet View' with columns for Activity ID, Activity Desc., Duration, Activity Type, Early Dates, Late Dates, Total Float, Calendar ID, Progress Type, and Progress Value. A help window titled 'Open Plan Help' is overlaid on the spreadsheet, showing a section titled 'Adjusting Column Width (Spreadsheet)'. The help text includes instructions on how to manually adjust column widths and how to use the 'Best Fit' and 'Size Column for Best Fit' options.

With Clip Notes, you can keep a list of steps in view as you perform the procedure.

The first time you start Open Plan, a special Clip Note automatically appears with tips about how to start entering information for your first project. Open Plan also displays Clip Notes automatically when you enter a blank view or data file display.

To display Help for a window

1. Press **F1**.

To display help for a dialog box

1. Click **Help** or press **F1**.

To display a table of contents for the help system

1. On the **Help** menu, click **Contents**.

To display help for a specific topic

1. Take one of the following actions:
 - On the **Help** menu, click **Search For Help On**.
 - From within a help window, click the **Search** tab.
2. Enter a keyword for the topic by typing the keyword or by selecting it from the list.

Open Plan displays a list of all topics matching your search criteria.

3. Select the topic from the list.

Displaying System Information

The **About Open Plan Professional** and **About Open Plan Desktop** message boxes display information about your Open Plan installation, including the version number, serial number, user information, and data source.

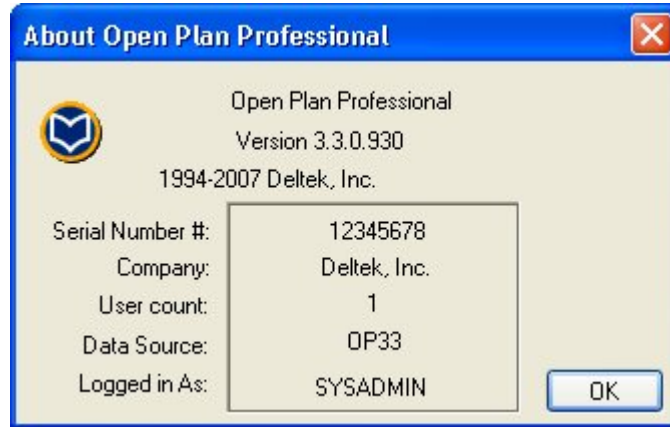

When contacting Deltek technical support, you may need this information for diagnostic purposes.

To display the About Open Plan dialog box take one of the following actions

- On the **Help** menu, click **About Open Plan Professional** or **About Open Plan Desktop**.
- On the toolbar, click the **About Open Plan** button.



About Open Plan
button

Exiting Open Plan

You can exit Open Plan at any time by clicking **Exit** on the **File** menu.

If you have any unsaved changes for project or data files that are open when you click the **Exit** command, Open Plan allows you to save your changes before closing the application.

To exit Open Plan

1. On the **File** menu, click **Exit**.



You can also exit Open Plan in certain situations by clicking the **Close** button in the upper right corner of the screen.

Where to Go from Here

Open Plan includes a number of tools to help you learn about the features and operations of the product.

This user's guide contains complete descriptions of the various features found in Open Plan and includes procedures for carrying out many common tasks. Chapter 2, "Basic Skills," and Chapter 3, "Getting Started," will help you master the basics of project planning in Open Plan. The rest of the chapters are organized on the basis of topics such as entering activity information and project analysis. The chapters do not have to be read in any particular order.

The Open Plan context-sensitive help system contains a wealth of information about using Open Plan and is available whenever you need it. For more complicated features, look for an **Examples** button in the help window for an extended explanation of the feature. To print a help topic, click **Print** within the help window.

Remember also that Clip Notes are good sources of information about performing procedures, and you can keep the instructions displayed as you carry out the task.

For in-depth information about advanced topics, refer to the *Deltek Open Plan Developer's Guide*. This guide includes information on topics such as customizing project views, standard file structures, compatibility issues, and OLE automation techniques

2

Basic Skills

➤ Overview	25
➤ Choosing Commands.....	26
➤ Working with Dialog Boxes	35
➤ Using Edit Boxes	38
➤ Using the Mouse	39
➤ Selecting Data.....	40
➤ Cutting, Copying, and Pasting Data.....	43

Overview

While offering the performance, functionality, and capacities of a high-end project management package, Open Plan provides a graphical interface based on recognized Windows standards. If you are experienced with using different Windows applications, most of the basic operations in Open Plan should seem familiar. If you are new to Windows software, however, you may want to take a few minutes to review the material in this chapter. Once you master a few of the basic skills required to use the Open Plan interface, you will find that these skills apply to many features in the package.

This chapter starts with descriptions of basic skills common to many Windows applications such as selecting commands, working with windows and dialog boxes, and using a mouse. Next, skills related to selecting, cutting, copying, and pasting data in the different views are discussed.



This chapter assumes that you already know how to perform basic operations such as using the mouse to click or drag items. If this is not the case, you may first want to review the appropriate sections of your Windows documentation before proceeding with the information in this chapter.

Choosing Commands

To select commands in Open Plan, you can use any of the following techniques:

- You can select a command from the menu bar displayed at the top of the Open Plan application window.
- You can select a command from the toolbar.
- You can select a command from a context menu displayed when you right-click an object or window.
- You can use keyboard short cuts to select a command.

Each of these techniques is described in the following sections.

Using the Menu Bar

The menu bar at the top of the Open Plan application window displays the names of menus containing available commands:

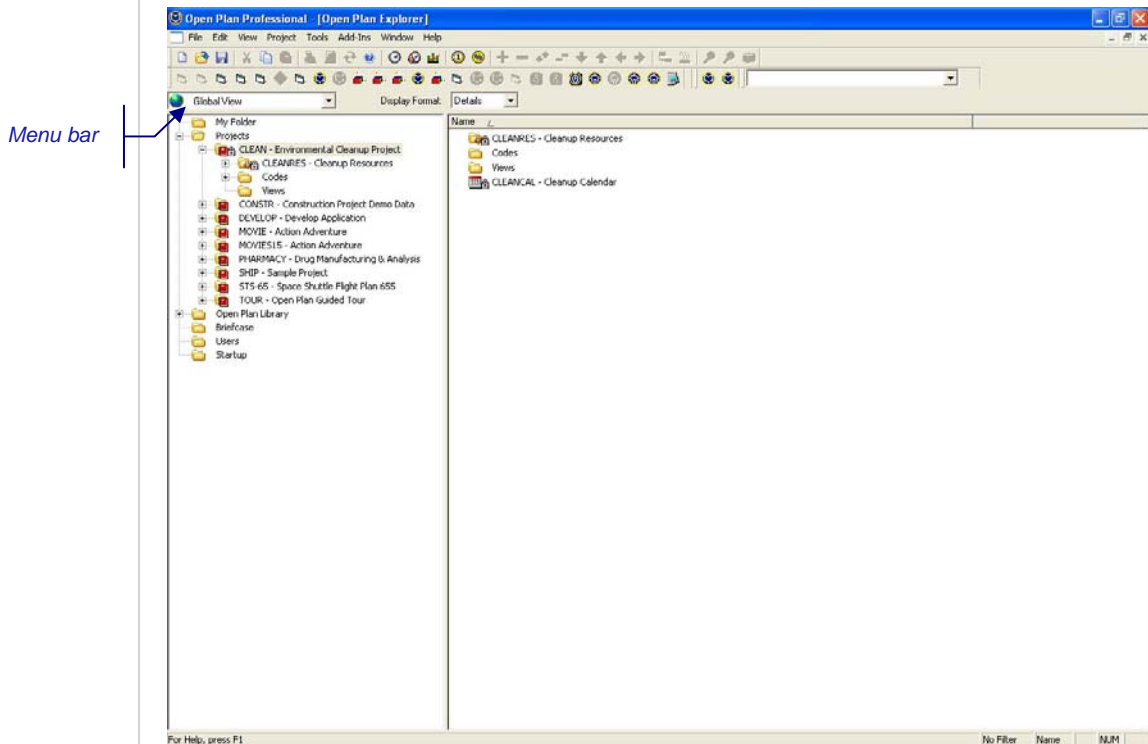

The same set of menus appears throughout Open Plan. The contents of the menus, however, may change depending on the current window or view.

When you click the name of a menu (or press the **Alt** key in combination with the first letter of the menu name), Open Plan displays the commands available from that menu:

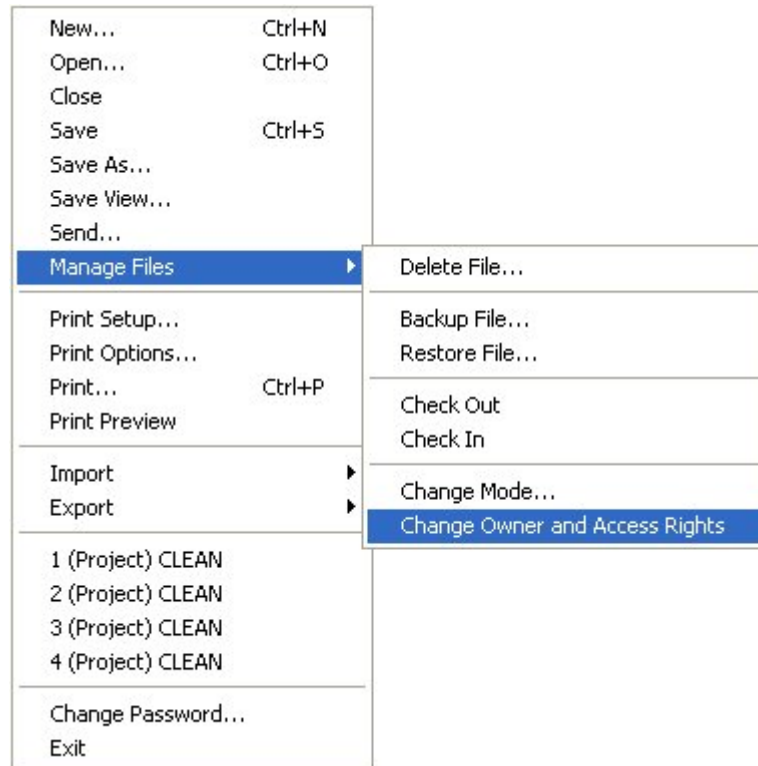

Notice that the names of some of the commands are dimmed. These commands are not available in a given situation.

Some commands have a right-pointing triangle next to their name on the menu. When you point to one of these commands, Open Plan displays a submenu of choices related to that command.

To select a command, simply click the name of the command. You can also select a command by typing the underlined letter in the command name.



If you do not see the underlined letter in the command name, it is possible that the version of Windows you are using has this function turned off. To turn on the underlining, refer to your Windows documentation.

To select a command from a menu







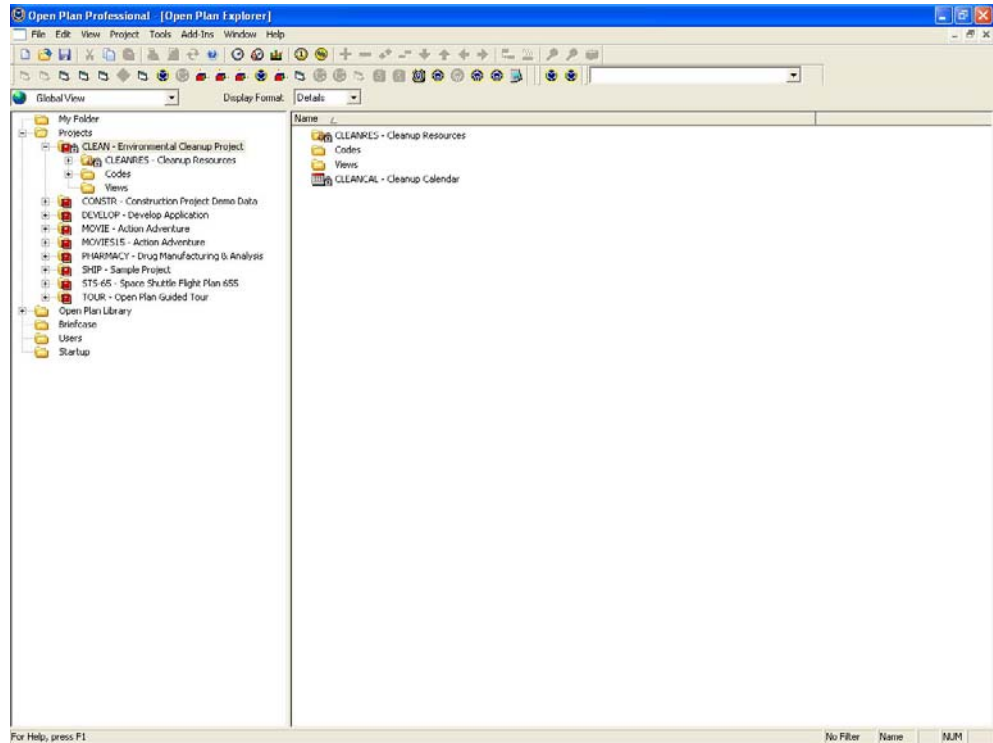

















1. Display the contents of a menu with one of the following actions:
 - Click the name of the menu.
 - Press the Alt key in combination with the first letter in the menu name.
2. Select a command with one of the following actions:
 - Click the name of the command.
 - Type the underlined letter in the command name.





Using the Toolbar

Many of the most commonly used commands are available as buttons on the toolbar.



To select a command from the toolbar, click the button for the command.
 Commands available from the toolbar are as follows:

Button	Command	Button	Command
	New		Progress Calculations
	Open		Expand
	Save		Collapse
	Cut		Expand All
	Copy		Collapse All
	Paste		Drill Down / Next Year
	Print		Drill Up / Previous Year
	Print Preview		Relationship Mode
	Refresh		Outdent
	About Open Plan		Indent
	Time Analysis		Bar Data Mode
	Resource Scheduling		Zoom In

Button	Command	Button	Command
	Risk Analysis		Zoom Out
	Cost Calculations		Snapshot

To display a description for a toolbar button, position the cursor on the button. Open Plan displays a description of the button on the status line at the bottom of the window and, after a short delay, next to the cursor as well. To continue without invoking the command, move the cursor off of the button.

As is the case with commands on the menu bar, dimmed buttons on the toolbar indicate that a specific command is not available in a given situation.

Open Plan displays the toolbar in the application window by default. You can, however, turn off the display of the toolbar at any time.



For more information on customizing the Open Plan system options, refer to Chapter 25, "System Defaults."

To select a command from the toolbar

1. Click the button representing the desired command.

Customizing Add-Ins Toolbars

Each custom tool in the **Add-Ins** menu can be displayed as an icon on a toolbar. Tools defined in the `addins.dat` file located in the Open Plan root directory can be displayed on the **System Add-Ins** toolbar. Tools defined in the `addins.dat` file located in the **User** directory of the Open Plan directory can be displayed on the **User Add-Ins** toolbar. You can display all or just some of the custom tools on the toolbars.

The **Customize Add-Ins Tool Bars** dialog box contains the following buttons that give you access to the three dialog boxes that you can use to customize the **Add-Ins** toolbars:

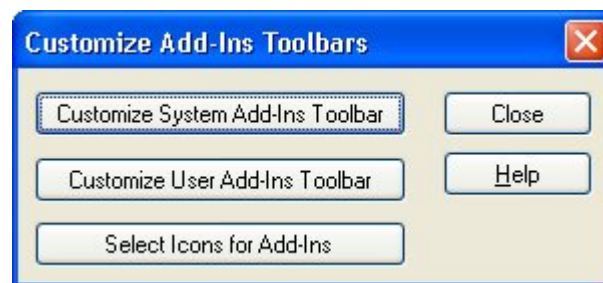

Clicking either **Customize System Add-Ins Tool Bar** or **Customize User Add-Ins Tool Bar** displays the **Customize Toolbar** dialog box where you can select the custom tools to display on the associated toolbar.

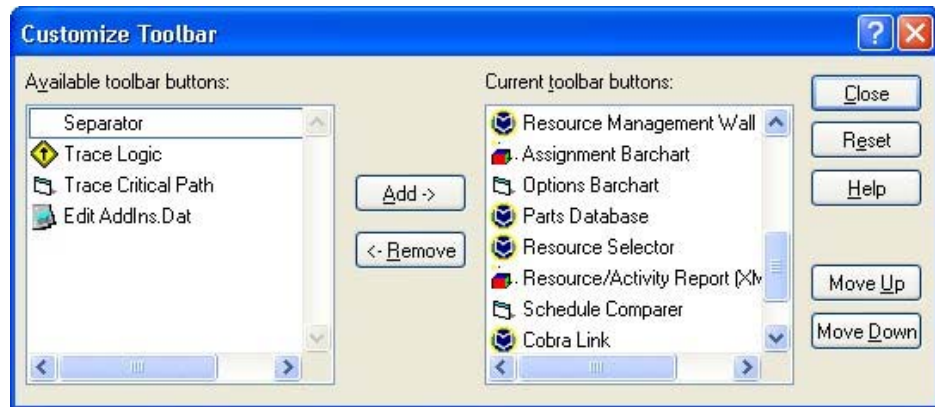

The **System** custom tools are defined in the addins.dat file located in the Open Plan root directory; the **User** custom tools are defined in the addins.dat file located in the **User** folder in the Open Plan root directory.

Clicking **Select Icons for Add-Ins** displays the **Customize Toolbar Icons** dialog box which you can use to assign an icon to a custom tool that is displayed on one of the **Add-Ins** toolbars.



The **Customize Toolbar Icons** dialog box allows you to change the icons used by the **Add-Ins** toolbar buttons.

The dialog box contains the following options:

- **Add-Ins** — This field lists all of the defined **Add-Ins** tools (both System tools and User tools):
- **Icon** — The current icon used for the button
- **Command** — The name of the tool as shown on the Add-Ins menu

System tools are defined in the addins.dat file located in the Open Plan root directory. User tools are defined in the addins.dat file located in the **User** directory of the **Open Plan** directory.

- **Select Icon for Command** — This field lists the available icons from which you can choose. If you select a command from the Add-Ins list that refers to a .exe file, the icons available in the .exe are displayed.

- **Replace Icon** — Once you select a command from the left-hand list and a new icon from the right-hand list, click the **Replace Icon** button to change the icon for the command.
- **Browse Icons** — Clicking this button displays an **Open** dialog box that you can use to select a .exe, .ico, or .dll file that contains the new icon you want to use. Once you have selected the appropriate file, the icons contained in the file are displayed in the **Select Icon for Command** list.



You can toggle the display of the toolbars in Open Plan by pointing to **Toolbars** on the **View** menu and then selecting the toolbars to display. Or, you can right-click an empty area of the toolbars section at the top of the Open Plan screen and then select the toolbars to display from the context menu.

Using the Right Mouse Button

Throughout Open Plan, you can display a context menu of commonly used commands by right-clicking an object or area of the screen. The contents of the context menu varies, depending on the location that you click.

In a network view, for example, right-clicking an activity displays the following menu of commands:



Right-clicking a relationship line displays the following menu:



Right-clicking an empty area of the workspace displays the following menu:

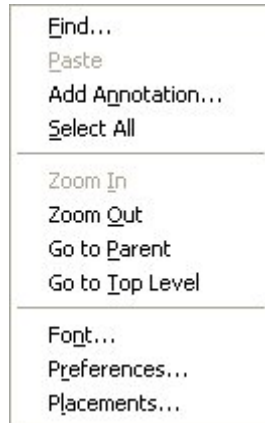

Right-clicking a selection button in an activity spreadsheet or barchart displays a menu that contains actions related to the Add-Ins menu:



Clicking a command on a context menu is identical to clicking a command on the Open Plan menu bar.

To display a context menu

1. Right-click an object or an area of the workspace.

Using Keyboard Shortcuts

You can select any command in Open Plan by a combination of keystrokes corresponding to the menu and the name of the command. For example, to execute the **Save** command on the **File** menu, press **Alt+F** to display the **File** menu, and then type **S**.

In addition, a number of commands in Open Plan have keyboard shortcuts that allow you to select them without having to display a menu.



Commands with keyboard shortcuts are listed in Appendix B, "Keyboard Shortcuts."

Working with Windows

Open Plan displays all data in windows that function identically to the document windows used in many standard Windows applications:

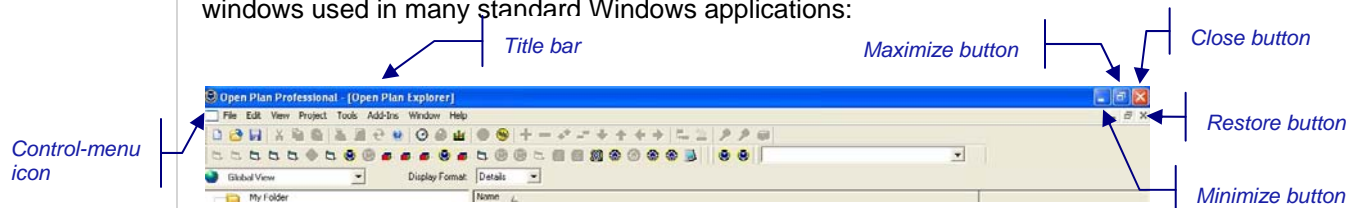

For information about the standard features of a document window, refer to your Windows documentation.

Open Plan allows you to display as many windows as you want at one time. You can also arrange, resize, and close windows as necessary.

As is common in many Windows applications, windows in Open Plan include a **Control** menu that allows you to perform basic functions related to the management of windows:



To display the **Control** menu, click the **Control-menu** icon in the upper-left corner of the window.

To select an open window

Take one of the following actions:

- Click anywhere in the window.
- Click the window on the **Window** menu.
- On the **Control** menu, click **Next**.



To select each open window in turn, press **Ctrl+Tab**.

To move a window using the mouse

1. Drag the title bar of the window to the desired location.

To move a window using the keyboard

1. On the **Control** menu, click **Move**.
2. Use the arrow keys to indicate the desired location of the window.
3. Press **Enter**.

To arrange all Open Plan windows

1. Take one of the following actions:
 - On the **Window** menu, click **Cascade**.
 - On the **Window** menu, click **Tile**

To resize a window using the mouse

1. Drag a border of the window to the desired shape.

To resize a window using the keyboard

1. On the **Control** menu, click **Size**
2. Use the arrow keys to move the window borders.
3. Press **Enter**.

To minimize a window

1. Take one of the following actions:
 - Click the **Minimize** button.
 - On the **Control** menu, click **Minimize**.

To maximize a window

1. Take one of the following actions:
 - Click the **Maximize** button.
 - On the **Control** menu, click **Maximize**.

To close a window

1. Take one of the following actions:
 - Click the **Close** button.
 - Double-click the **Control-menu** icon.
 - On the **Control** menu, click **Close**.

Working with Dialog Boxes

In many places in Open Plan, you enter and update information using a dialog box. The contents of a dialog box can range in complexity from a single text box to multiple lists, items, commands, and options:

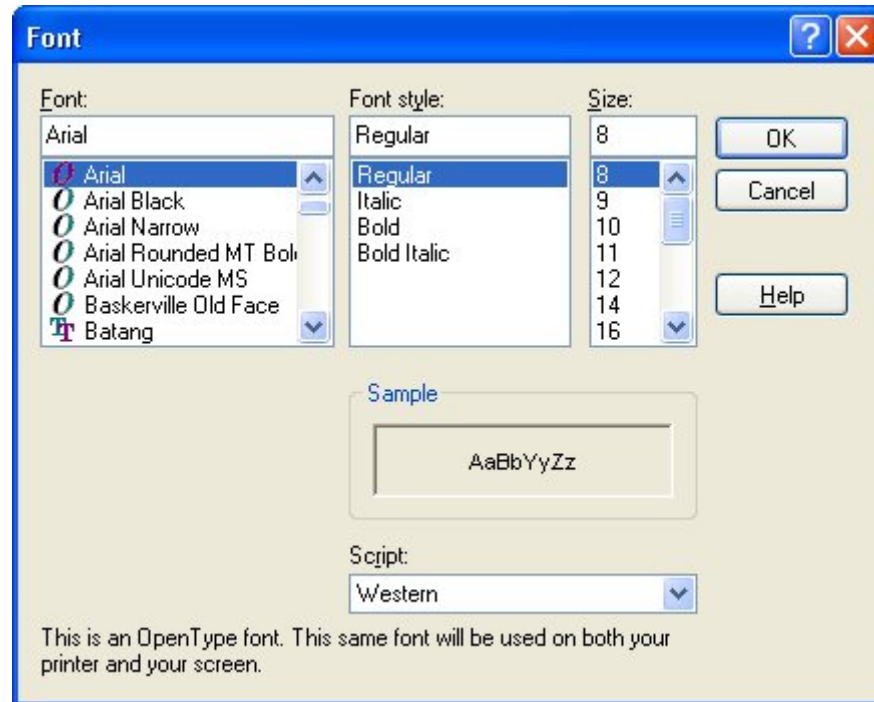

Although dialog boxes vary considerably in their functions, the following elements are common to many dialog boxes:

- **Text boxes** — Enter text by typing
- **List boxes** — Select an item from a list of available choices
- **Check boxes** — Select one or more options
- **Radio buttons** — Click one option from a group of options
- **Command buttons** — Perform an operation from within the dialog box

To move between the different items in a dialog box, simply click on the item, or press the **Tab** key. You can also go to a specific item by pressing the **Alt** key in combination with the underlined letter in the item label.

Most dialog boxes have at least three command buttons: **OK**, **Cancel**, and **Help**. Clicking these buttons has the following results:

- **OK** — Saves any changes you have made and closes the dialog box
- **Cancel** — Closes the dialog box without saving any changes
- **Help** — Displays help information for this dialog box

Dialog boxes usually have a default command, which you can execute by pressing **Enter**. (Open Plan displays a special outline border around the default button of a dialog box.)

You can always select **Cancel** in a dialog box by pressing **Esc**.

Using Tabbed Dialog Boxes

Tabbed dialog boxes are dialog boxes that group similar options, commands, and settings together using tabs that are similar to file tabs in a filing cabinet:

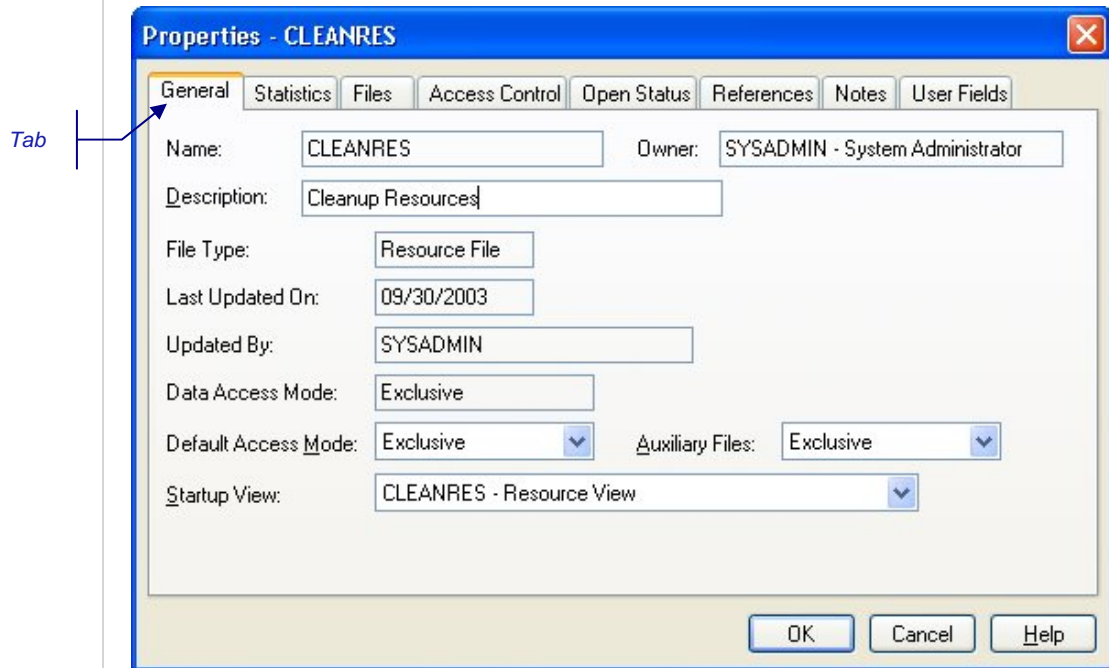

To display the different tabs in a tabbed dialog box, simply click the tabs.

Going from one tab to another does not automatically save any changes you may have made on the first tab. In tabbed dialog boxes, there is only one set of command buttons. These commands affect all of the settings in the dialog box, not just those on the tab currently displayed. If you click **Cancel** or **Undo**, Open Plan does not save any changes you have made to settings on other tabs in the dialog box.

Using Modeless Dialog Boxes

A number of dialog boxes in Open Plan are modeless; in other words, you can leave these dialog boxes open when performing other operations. This allows you, for example, to open the **Activity Details** dialog box from a spreadsheet view and then view the detailed information for specific activities simply by clicking them in the view without having to close and re-open the dialog box each time.

You can also use modeless dialog boxes to scroll through the records in a file. Four navigation buttons in the lower left corner of the dialog box provide this functionality:

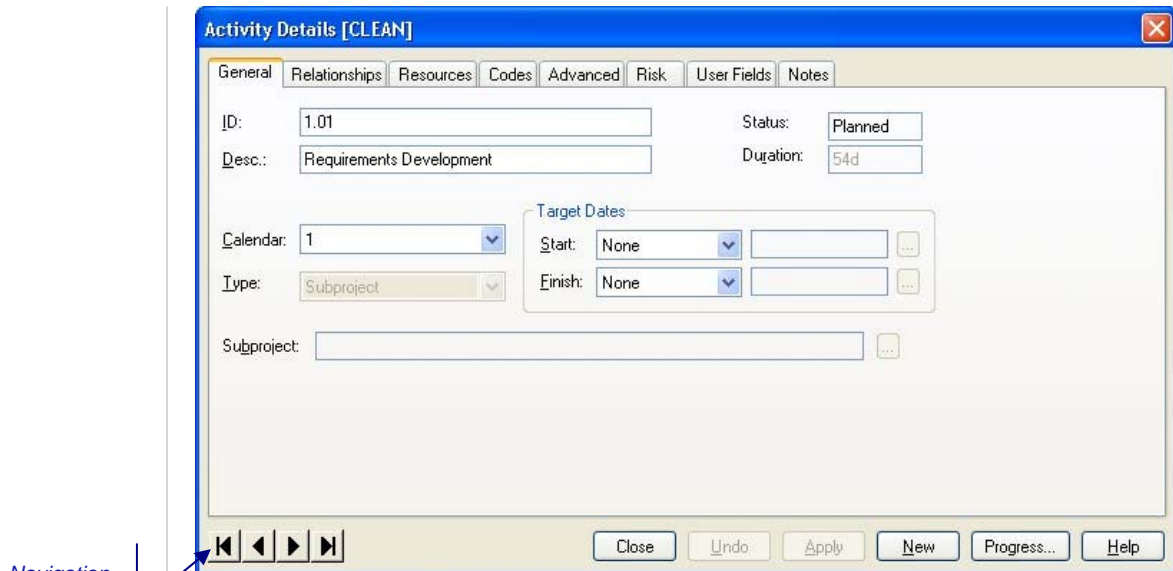

Navigation
buttons

Use these controls to go to the first record in the file, the previous record, the next record, or the last record in the file.



You can also use the following keyboard shortcuts to scroll through the records in the file: **Page Up/Page Down** (go to previous/next record) and **Ctrl+Home/Ctrl+End** (go to first/last record).

If you select a group of items in the view with a modeless dialog box open, you can use the navigation buttons on the dialog box to scroll through the selected items. You can also configure Open Plan to synchronize multiple modeless dialog boxes so that using the navigation buttons on one dialog box will result in Open Plan scrolling to the appropriate item on another dialog box.



For information about enabling this feature, refer to Chapter 25, "System Defaults."

Because you can update multiple items without having to close a modeless dialog box each time, Open Plan automatically saves any changes you make to an item before displaying the next record. As a result, the **OK** and **Cancel** buttons on a non-modal dialog box have been replaced with a **Close** button. When you click this button, Open Plan closes the dialog box and returns to the view. If you have not saved the information currently displayed, Open Plan saves the changes before returning to the view.

Some modeless dialog boxes also include an **Undo** button that returns the dialog box to its previous state and an **Apply** button that saves the changes you made to the current record.



You must update information for an item before the **Undo** and **Apply** buttons become active.

Using Edit Boxes

For entering some types of information, Open Plan provides an edit box in which you can type the information directly.

Click to cancel entry.



Click to save entry.















Click to display list.

Each edit box includes two buttons: one for canceling the entry and the other for saving the entry. Many edit boxes also include a button for displaying a list of valid choices for the item. For some types of information (for example, colors), using the list is the only way you can enter a selection.

Edit boxes appear in all spreadsheet views as well as in many dialog boxes.

Using the Mouse

You can use the mouse to perform various operations throughout Open Plan. In many cases, the shape of the cursor indicates the type of operation you can perform in a certain situation. The following table lists the various types of cursors that can occur in Open Plan.

Cursor	Occurs In	Function
	All windows	Select item
	Network and barchart views	Draw relationship
	Network and barchart views	Update relationship
	Network and spreadsheet views	Move activity box, annotation, expanded subproject, legend, or spreadsheet column
	Network views	Resize activity box, annotation, or legend
	Network views	Paste activity
	Barchart views	Drag pane boundary
	Barchart views	Set target start date
	Barchart views	Set duration
	Barchart view	Enter progress
	Barchart and histogram views (date scale)	Expand or compress date scale
	Spreadsheet views and text boxes	Insert text data
	Spreadsheet views	Resize column width
	Print preview window	Zoom in

Selecting Data

When you select data in Open Plan, you indicate the item on which the next action should be carried out. Selecting data is a basic skill that you use as a preliminary step in a number of operations. However, the exact procedure for selecting a particular type of data depends on the nature of the item and the context in which the selection occurs.

You can select data in the following situations in Open Plan:

- Text displayed in dialog text boxes, edit boxes, or cells in a spreadsheet view
- One or more items in a list
- Icons in an Open Plan window
- Activities in network, spreadsheet, or barchart views
- Columns and ranges of cells in spreadsheet views
- Elements in a resource or code display
- Days in a calendar display

To select text in text boxes, edit boxes, or spreadsheet cells

1. Take one of the following actions:
 - Drag the cursor over the text.
 - Double-click the text, and press the **Shift** key in combination with the **Left** or **Right arrow** key.

To select an item in a list

1. Take one of the following actions:
 - Click the item.
 - Press the **Up** or **Down arrow** key to select the item.
 - Type the first letter of the item.

To select contiguous items in a list

1. Take one of the following actions:
 - Drag the cursor across the items.
 - Click the first item, then **Shift-click** the last item of the group.
 - Press the **Shift** key in combination with the **Up** or **Down arrow** key.

To select non-contiguous items in a list

1. Click the first item, then **Ctrl-click** subsequent items.

To select items displayed as icons

1. Click the icon for the item.

To select activities in a network view

1. Take one of the following actions:
 - Click the activity box.
 - Draw a selection rectangle around the activities you want to select.

To select all activities in a network view

1. Display the top level of the project hierarchy.



For information about displaying project hierarchies in a network view, refer to Chapter 12, "Hierarchical Projects."

2. On the Edit menu, click **Select All**.

To select activities in a spreadsheet view

1. Click the selection button to the left of the activity row.



To select a contiguous group of activities, select the first activity of the group, then **Shift-click** the last activity of the group.

To select a non-contiguous group of activities, select the first activity of the group, then **Ctrl-click** subsequent activities.

To select all activities in a spreadsheet view

1. Take one of the following actions:
 - On the **Edit** menu, click **Select All**.
 - Right-click a column heading, and click **Select All** on the context menu.
 - Click the selection button to the left of the column headings.



View filters can affect the operations of the **Select All** command. For information about view filters, refer to Chapter 23, "Project Utilities."

To select columns in a spreadsheet view

1. Click the column heading.



To select a contiguous group of columns, select the first column of the group, then **Shift-click** the last column of the group.

To select a non-contiguous group of columns, select the first column of the group, then **Ctrl-click** subsequent columns.

To select a range of cells in a spreadsheet view

1. Drag the cursor diagonally across the range of cells.

To clear a selection in a spreadsheet view

1. Click anywhere outside of the selection.

To select an element in a resource file or code file display

1. Click the resource or code.

To select a date in a calendar display

1. Click the date.

Cutting, Copying, and Pasting Data

Open Plan supports the standard cut, copy, and paste operations found in many Windows products that allow you to transfer information using a clipboard function stored in memory. The definitions for these operations are as follows:

- **Cut** — Removes the selected information from its present location and stores it on the Clipboard. (Notice that cutting an item is not the same as deleting an item. Deleting an item does not change the contents of the Clipboard.)
- **Copy** — Makes a copy of the selected information and stores it on the Clipboard.
- **Paste** — Inserts the current contents of the Clipboard.
- **Paste Special** — Displays the **Confirm Paste** dialog box which is used to control ID renumbering options.

In Open Plan, you can cut, copy, and paste text displayed in a text box on a dialog box, in an edit box (which may appear in either a dialog box or in a spreadsheet view), and in a spreadsheet cell. You can also cut, copy, or paste activities displayed in a barchart, codes, network, resource, and spreadsheet view. You can use these commands to transfer data within a single project or between different projects. This makes it possible, for example, to define a group of activities in one project and then copy that group to other projects as well.



You can also cut or copy data from a spreadsheet view, a network view, or a display of resources or codes and then paste it into another application such as Microsoft Excel or Microsoft Word. Open Plan stores any data as tab-delimited text with a line feed at the end of each record. The first record always consists of the column headings for the data you have cut or copied.

To cut text in a text box, edit box, or spreadsheet cell

1. Select the text you want to cut.
2. Take one of the following actions:
 - Press **Ctrl+X**.
 - In a spreadsheet view, click **Cut** on the **Edit** menu.
 - In a spreadsheet view, click the **Cut** button on the toolbar.



Cut button

To copy text in a text box, edit box, or spreadsheet cell

1. Select the text you want to copy.
2. Take one of the following actions:
 - Press **Ctrl+C**.
 - In a spreadsheet view, click **Copy Text** on the **Edit** menu.
 - In a spreadsheet view, click the **Copy** button on the toolbar.
 - In a spreadsheet view, right-click the cell, and click **Copy Text** on the context menu.



Copy button

To paste text into a text box, edit box, or spreadsheet cell

1. Cut or copy the text you want to paste.
2. Position the insertion cursor in the text box, edit box, or spreadsheet cell.
3. Take one of the following actions:
 - Press **Ctrl+V**.
 - On the **Edit** menu, click **Paste Text**.
 - On the toolbar, click the **Paste** button.
 - In a spreadsheet view, right-click the cell, and click **Paste Text** on the context menu.



Paste button

To cut activities in a network view

1. Select the activities you want to cut.
2. Take one of the following actions:
 - Press **Ctrl+X**.
 - On the **Edit** menu, click **Cut**.
 - On the toolbar, click the **Cut** button.
 - Right-click the activity, and click **Cut Activities** on the context menu.



Cut button

To paste activities in a network view

1. Cut or copy the activities you want to paste.
2. Take one of the following actions:
 - Press **Ctrl+V**.
 - On the **Edit** menu, click **Paste**.
 - On the toolbar, click the **Paste** button. Open Plan displays a paste cursor.
3. Move the paste cursor to the desired location in the view, and click.



Paste button



Paste



If necessary, Open Plan rennumbers any pasted activities that duplicate the IDs of existing activities.

To cut activities in a spreadsheet view

1. Select the activities you want to cut.
2. Take one of the following actions:
 - Press **Ctrl+X**.
 - On the **Edit** menu, click **Cut Record(s)**.
 - On the toolbar, click the **Cut** button.
 - Right-click a selection button, and click **Cut Record(s)** on the context menu.



Cut button

To copy activities in a spreadsheet view

1. Select the activities you want to copy.

2. Take one of the following actions:

- Press **Ctrl+C**.
- On the **Edit** menu, click **Copy Record(s)**.



On the toolbar, click the **Copy** button.

Right-click either a selection button or an activity row, and click **Copy Record(s)** on the context menu.

To paste activities in a spreadsheet view

1. Cut or copy the activities you want to paste.

2. Take one of the following actions:

- Press **Ctrl+V**.
- On the **Edit** menu, click **Paste Record(s)**.
- On the toolbar, click the **Paste** button.



- Right-click an activity row or an empty area of the view, and click **Paste Record(s)** on the context menu.



If necessary, Open Plan rennumbers any pasted activities that duplicate the IDs of existing activities.

To paste resources in a resource view

1. Cut or copy the resources you want to paste.

2. Take one of the following actions:

- To paste to the top level, click an empty area of the view.
- To paste as a child, select the target parent resource. (Note: You cannot add a child to a resource that is already defined as having availabilities.)

3. Take one of the following actions:

- Press **Ctrl+V**.
- On the **Edit** menu, click **Paste**.
- On the toolbar, click the **Paste** button.



If necessary, Open Plan rennumbers any pasted resources that duplicate the IDs of existing resources.

3

Getting Started

➤ Overview	49
➤ Describing the Open Plan Explorer.....	50
➤ The Hierarchical Pane.....	51
➤ The Contents Pane	55
➤ Using the Open Plan Explorer	60

Overview

The Open Plan Explorer provides a familiar graphical user interface (GUI) similar to Windows Explorer in order to simplify the task of managing your project data.

This chapter begins with detailed descriptions of the two panes of the Open Plan Explorer. It concludes with discussions on how to manage your project data using the various commands available to the Open Plan Explorer.

Describing the Open Plan Explorer

The Open Plan Explorer interface contains two panes with a moveable splitter bar between them. The left pane displays a hierarchy of nested folders through which you navigate. The right pane displays the contents of the currently selected folder.

The left pane displays a hierarchy of nested folders.

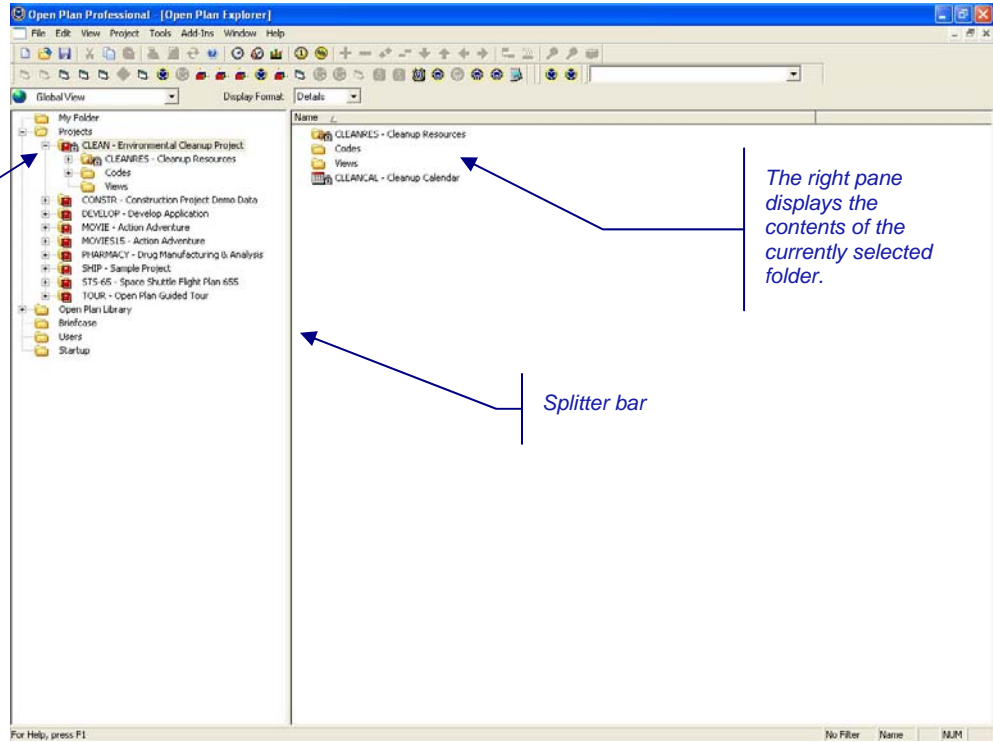

The right pane displays the contents of the currently selected folder.

Splitter bar

The Hierarchical Pane

The left pane of the Open Plan Explorer displays a hierarchy of folders available to you. When you start Open Plan, you are presented with six default folders:

- My Folder
- Projects
- Open Plan Library
- Briefcase
- Users
- Startup

Each folder can contain other folders or Open Plan objects such as projects and views. You also can create custom folders within your My Folder or within any individual project, resource, or code folder to help organize your project data. You also can create a custom folder within a custom folder.



The custom folders you create are not available to other users in the data source.

To create a custom folder

1. Select the folder in which you want to create the custom folder.
2. Take one of the following actions:
 - In the hierarchical pane, right-click the folder.
 - In the contents pane, right-click an empty space.
3. On the context menu, click **New Folder**.
4. Enter a name for the folder, and press **Enter**.

You can also perform standard Windows operations in the hierarchy such as dragging and dropping objects into Open Plan folders or using a context menu to manipulate a selected object.

The following sections detail each of the six default folders.

My Folder

This is your personal folder. It provides a convenient way of organizing all the links to your projects, views, auxiliary files, and application shortcuts. These objects can be referenced in this folder in either of the following ways:

- By creating a project
- By dragging a project, view, auxiliary file, or application shortcut from another folder to My Folder



Deleting an object from My Folder deletes the link rather than the actual data.

Projects

All projects in the data source — either created by you or created by someone else and to which you have been given rights to view or manipulate — are listed in the Projects folder together with their views and auxiliary files.

When you create a project, it is placed in the Projects folder and a link to it is automatically placed in your My Folder. You can also drag existing projects from this folder to your My Folder to establish a link.



Deleting a project from the Projects folder deletes both the actual project data from the database and the link to it in My Folder. No auxiliary files are deleted with the project in the Project folder.

Open Plan Library

This folder contains auxiliary files (calendars, codes, resources, and views) that can be linked to projects. Each type of auxiliary file has its own subfolder. To create a link to an auxiliary file, simply drag the file from the Open Plan Library to the target project folder.

As auxiliary files are created in Open Plan, they are automatically added to the appropriate folders of the Open Plan Library. You cannot drag a file directly into the Open Plan Library.



Provided that you have sufficient rights and the file is not referenced by another file, you can delete it from the Open Plan Library. Deleting a file from here deletes both the actual data from the database and any links to that file that may exist.

Briefcase

Briefcasing is the ability to take a copy of a project stored in the central database and work on that copy remotely. The database restricts access to the master copy to prevent changes being made, which would be lost when the remote copy is returned. While briefcased, other users are only able to open the project in **Read Only** mode.

The Briefcase folder displays the following information for projects that have been checked out:

- Who has a project checked out
- The date and time the project was checked out



For more information on checking out projects, refer to the “Briefcasing” section in Chapter 24, “System Utilities.”

Users

This folder displays a list of users who are currently logged into Open Plan. The following information is available for each user in the contents pane:

- User ID

- Login Time
- Machine ID

You can control what information is displayed in this folder by customizing the folder headings. By default, only the **User ID** column is displayed.



For more information, refer to the “Customizing the Details Format Display” section later in this chapter.

You can also view what files a user has open by displaying the **Logged-in User** dialog box:

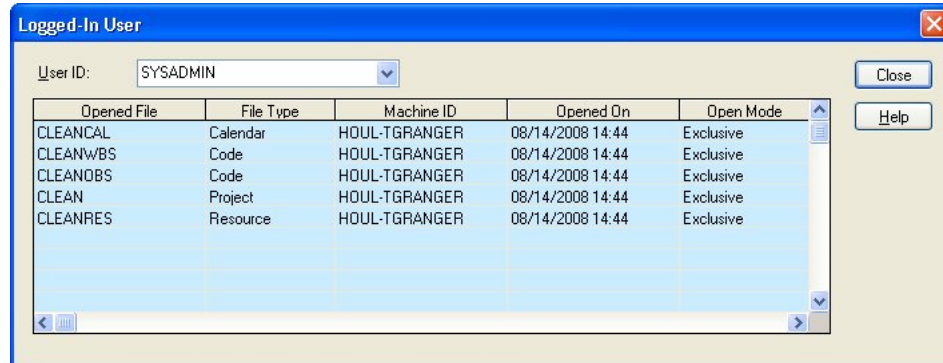

The **User Id** field lists all the users currently logged into your Open Plan data source. Selecting a user from the list displays the files that the user has open.

When you display the **Logged-in User** dialog box, the default user selected in the User Id field depends on the following:

- If you display the **Logged-in User** dialog box from the hierarchical pane, the default user shown in the **User Id** field is the first user in the list of users.
- If you display the dialog box for a specific user in the contents pane, that user is automatically selected in the **User Id** field.

Regardless of how you display the **Logged-in User** dialog box, you still can access all the other users from the list.

The following information is displayed for each file the user has open:

- **Opened File** — The name of the file opened
- **File Type** — The type of file opened (**Project**, **Calendar**, **Resource**, or **Code**)
- **Machine ID** — The computer from which the file was opened
- **Opened On** — The date and time the file was opened
- **Open Mode** — The mode (**Exclusive**, **Shared**, or **Read Only**) in which the file is open

To display the Logged-in User dialog box

1. From the hierarchical pane, select the **Users** folder
2. Take one of the following actions:
 - Right-click the **Users** folder, and click **Properties** on the context menu.

- In the contents pane, right-click a user ID, and click **Properties** on the context menu.

Startup

Each Open Plan user has his own Startup folder. You can use this folder to store shortcuts to data or applications that you want to run each time you start Open Plan. For example, if you want a particular project to open or Windows Notepad to start automatically when Open Plan starts, place a shortcut to it in this folder.

Dragging an object into this folder establishes the **Startup** link, and deleting the icon in the **Startup** folder removes the link.



For more information on creating an application shortcut, refer to the “Creating an Application Shortcut” section later in this chapter.

The Contents Pane

The right pane of the Open Plan Explorer displays the contents of the currently selected folder in the hierarchical pane. There are three display formats:

- **Details** — In addition to identifying the object by its name, the **Details** format also displays additional information about each object such as description, open mode, user ID, etc. The type of information displayed in the **Details** format can be controlled by customizing the folder headings.
- **Small Icons** — In this format, Open Plan displays a small icon for each object together with its name.
- **Large Icons** — In this format, Open Plan displays a large icon for each object together with its name.



For more information on customizing folder headings, refer to the “Customizing the Details Format Display” section later in this chapter.

If you let the cursor hover over an object while in the **Small Icon** or **Large Icon** format, a popup with a brief description of the object will be displayed.

Double-clicking an object can invoke the following operations:

- If the object is a folder, double-clicking expands it.
- If the object is a view or calendar, double-clicking opens the object.
- If the object is an application shortcut, double-clicking launches the application.

Customizing the Details Format Display

You can customize the display of information in the **Details** format.

Right-clicking a heading on the header bar displays a context menu where you can perform the following actions:

- **Customize Columns** — Displays the **Customize Columns** dialog box where you can customize the columns that are displayed in the **Details** format.



You can also display the **Customize Columns** dialog box by double-clicking anywhere on the header bar.

- **Remove Column** — Removes the target column from the display.
- **Rename Column** — Renames the target column in the display.
- **Sort Ascending** — Performs an ascending sort on the target column. An arrow placed next to the column heading indicates which column is being sorted on and the direction of the sort.
- **Sort Descending** — Performs a descending sort on the target column. An arrow placed next to the column heading indicates which heading is being sorted on and the direction of the sort.
- **Best Fit** — Resizes the width of the target column to properly display the entries in the column.



In order to customize the columns in the contents pane, the folder that is displayed must contain only like objects. For example, the objects must be all views, all projects, etc.

Customize Columns

You can customize the columns displayed in the **Details** format by displaying the **Customize Columns** dialog box:

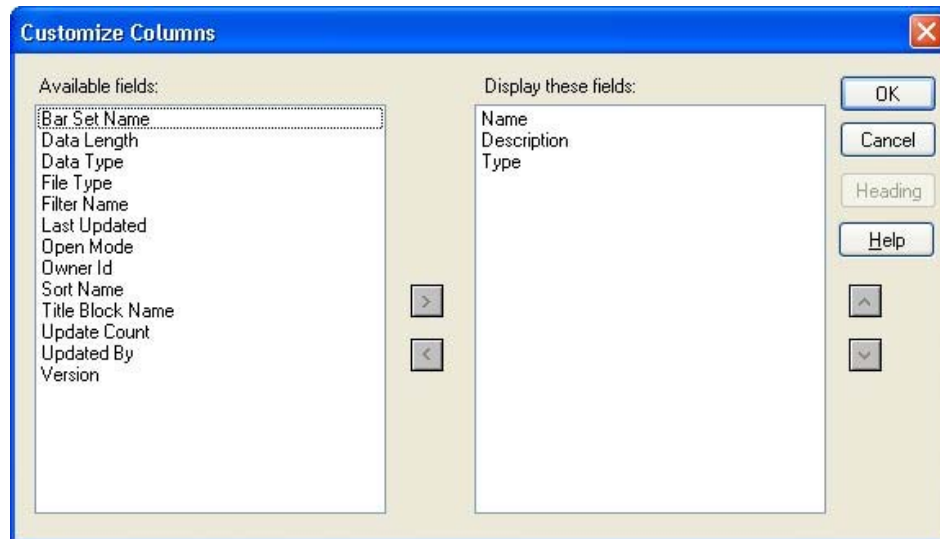

From this dialog box, you can perform the following actions:

- Add fields for display
- Remove fields from display
- Rearrange the display order
- Rename columns using the **Heading** button

To add a column using the **Customize Columns** dialog box

1. Display the **Customize Columns** dialog box by taking one of the following actions:
 - Double-click the header bar.
 - Right-click the header bar, and click **Customize Columns** on the context menu.
2. For each column you want to display, select the field from the **Available fields** list, and click **>**.

This action moves the selected field to the **Display these fields** list.

3. When finished, click **OK**.

To remove a heading using the **Customize Columns** dialog box

1. Display the **Customize Columns** dialog box by taking one of the following actions:
 - Double-click the header bar.

- Right-click the header bar, and click **Customize Columns** on the context menu.
2. For each column you want to remove from display, select the field from the **Display these fields** list, and click **<**.
 3. When finished, click **OK**.



An alternative way to add or remove a heading is to double-click the field name on the **Customize Columns** dialog box. Double-clicking has the same result as selecting the field and clicking **>** or **<**.

To rearrange the column display order using the Customize Columns dialog box

1. Display the **Customize Columns** dialog box by taking one of the following actions:
 - Double-click the header bar.
 - Right-click the header bar, and click **Customize Columns** on the context menu.
2. In the **Display these fields** list, select the field to move.
3. Use the up or down arrow buttons to reposition the selected field.
4. When finished, click **OK**.

Remove Column

When you right-click on the header bar to display the context menu, notice that each heading displayed in the **Details** format is listed on the context menu with a check mark next to it:

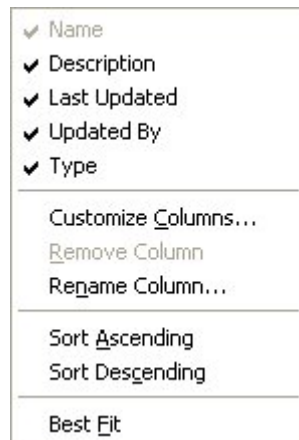

There are three ways to remove a heading from the **Details** format:

- By using the **Customize Columns** dialog box (discussed in the previous section)
- By using the **Remove Column** command
- By clearing the check mark from the heading on the context menu.

To remove a column from display

1. Take one of the following actions:

- Right-click the column to remove, and click **Remove Column** on the context menu.
- Right-click the header bar, and clear the check mark from the heading you want to remove

Rename Column

You can use the following dialog box to rename a column heading to reflect your own organizational methods:

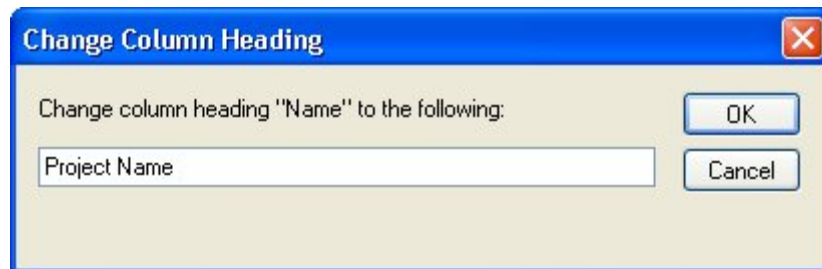

To rename a column heading

1. Display the **Change Column Heading** dialog box by taking one of the following actions:
 - Display the **Customize Columns** dialog box, select the field from the right pane to be renamed, and click **Heading**.
 - Right-click the column heading to be renamed, and click **Rename Column** on the context menu.
2. In the **Change Column Heading** dialog box, enter the new name.
3. Click **OK**.

Sort Ascending

You can perform an ascending sort based on any column of the contents pane when in the **Details** format. An up arrow next to the column heading indicates which column is being sorted on and the direction of the sort.

To perform an ascending sort of the Details format

1. Right-click the column heading on which to sort.
2. On the context menu, click **Sort Ascending**.

Sort Descending

You can perform a descending sort based on any column of the contents pane when in the **Details** format. A down arrow next to the column heading indicates which column is being sorted on and the direction of the sort.

To perform a descending sort of the Details format

1. Right-click the column heading on which to sort.
2. On the context menu, click **Sort Descending**.

Group by Option

Clicking this item places the contents into expandable groups by object type. For example, selecting a project from the hierarchical pane of the Open Plan Explorer, right-clicking the Name column in the Details pane, and selecting Group by Type places the project contents into three groups: **Calendars**, **Resources**, and **System Folder**. Clicking a group heading expands the folder to reveal the contents.

Right-clicking a group heading displays the following additional options:

- **Collapse** — Collapses the selected expanded group heading
- **Collapse All** — Collapses all expanded group headings
- **Expand** — Expand the selected group heading
- **Expand All** — Expands all group headings
- **Group Ascending** — Sorts the groups in ascending order. (This is the default.)
- **Group Descending** — Sorts the groups in descending order
- **Ungroup** — Removes the applied grouping



You can sort the contents within the groups (but not the groups themselves) in ascending or descending order by right-clicking a column heading (not a group heading) and selecting **Sort Ascending** or **Sort Descending**.

Ungroup

Clicking this item allows you to remove the applied grouping. You can access this item by either right-clicking a column heading or a group heading.

Best Fit

When applied, the **Best Fit** option instructs Open Plan to resize the width of a selected column. Open Plan will either shrink the column width by eliminating unneeded space or widen the column to properly display all entries.

To resize the column width

1. Right-click the heading of the column to be resized.
2. On the context menu, click **Best Fit**.



You can also resize a column's width manually by placing the cursor at either edge of column's header. When the cursor changes to this shape , click and drag the column edge to the desired width.

Using the Open Plan Explorer

At the top of the hierarchical pane is a list that shows all open projects. If you use the list to select an open project, the hierarchical pane is limited to that project only.

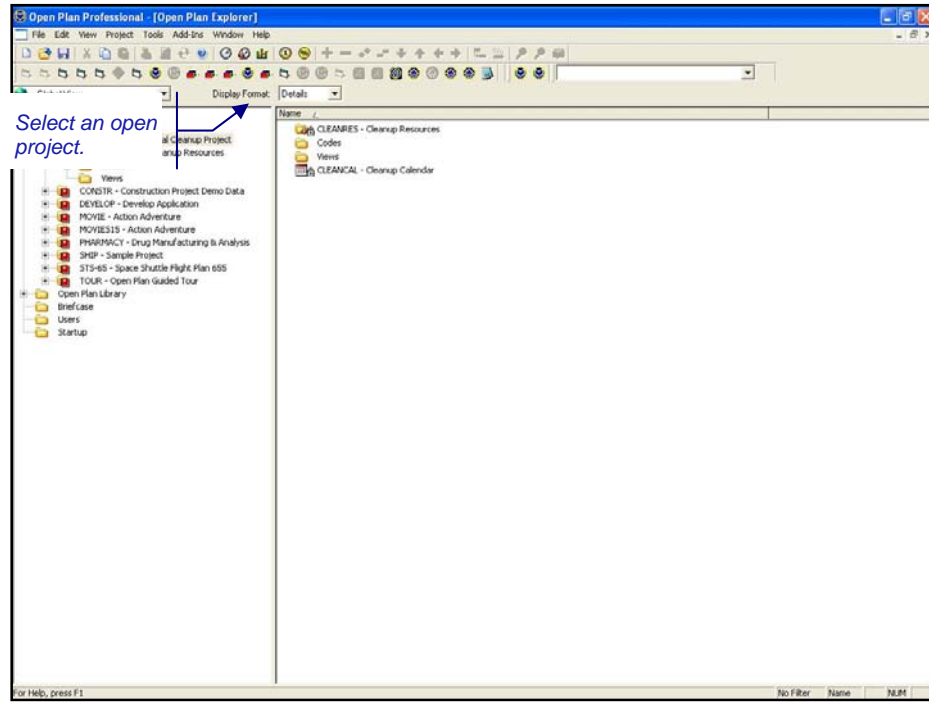

Selecting **Global View** displays the full hierarchy of folders.

Opening a Project or Auxiliary File

When you open a project, all auxiliary files associated with the project are also opened. It is also possible to open an auxiliary file or view without first having to open the project.

There are two ways to open a project or auxiliary file:

- Using the **File Open** dialog box
- Right-clicking a project or auxiliary file and clicking **Open** on the context menu. (A view can also be opened in this manner.)



Another way to open a view is by double-clicking its icon.

Open Plan displays the following dialog box when you click **Open** on the **File** menu or click the **Open** button on the toolbar:

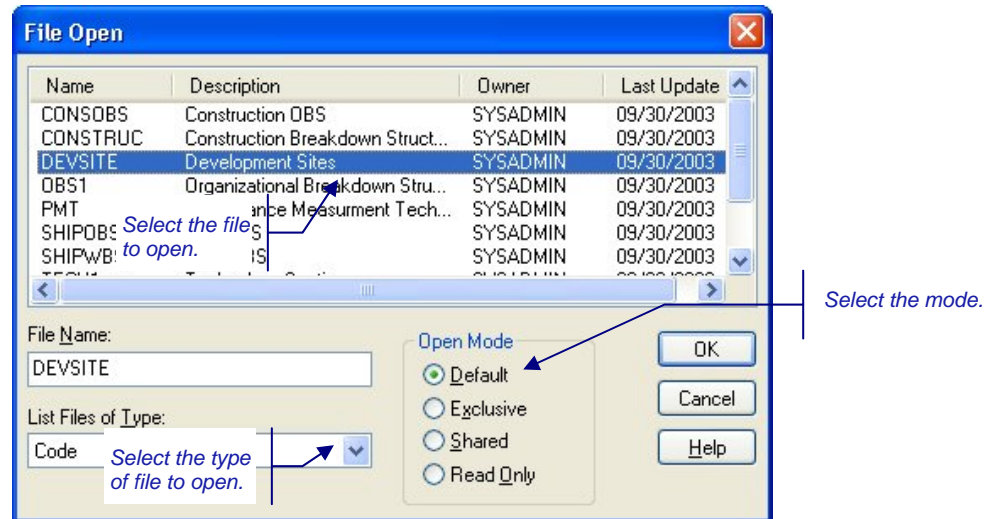

You can use the **List Files of Type** list to display the project, calendar, resource, or code files from which to select.

Before you can open a file, you must specify the mode in which to open it:

- **Default** — If you are opening a project, Open Plan opens the project and its auxiliary files in the mode specified on the **Preferences** tab of the **Project Properties** dialog box. This setting overrides the default access mode for the auxiliary file as set on its own **Properties** dialog box.
- **Exclusive** — Opening the file in this mode allows you to update the information for the file and save any changes. Other users must use the **Read Only** mode if they wish to open the file while you are using it.
- **Shared** — Opening the file in this mode allows other users to open the file in the same mode, giving them the ability to make changes while you have it open.
- **Read Only** — Opening the file in this mode means you cannot edit the information in any way.

If the file you want to open is already open by another user, Open Plan enables or disables the four access modes as appropriate depending on the mode in which the file is already open. For example, if the file you want to open is already opened by another user in **Exclusive** mode, Open Plan will disable the first three modes and only allow you to choose **Read Only**.

You can open multiple files at once by **Shift**-clicking or **Ctrl**+clicking the desired files.



For more information on the exclusive, shared, and read-only modes, refer to Chapter 24, "System Utilities."

To open a file using the File Open dialog box

1. Take one of the following actions:
 - On the **File** menu, click **Open**.
 - Press **Ctrl+O**.
 - On the toolbar, click the **Open** button.



Open button

2. Select the file to open.
3. Use the **List Files of Type** list to display the type of file you want to open.
4. Click the mode in which to open the file.
5. When finished, click **OK**.

To open a file using the context menu

1. Right-click the file you want to open.
2. On the context menu, point to **Open**.
3. On the **Open** submenu, click the mode in which to open the project.



When you open a project (regardless of the access mode you select), the auxiliary files associated with the project are opened in the default access mode established on the **Preferences** tab of the **Project Properties** dialog box. If you open an auxiliary file outside the context of a project, clicking **Default** on the **Open** submenu opens the auxiliary file in the default access mode established on the **Properties** dialog box for that file.

Creating a New Project or Auxiliary File

When you create a new project or auxiliary file, you have the option of creating it using default settings or using the **New File Wizard** to specify some or all of the settings. When the project or auxiliary file is created, it is placed in the appropriate system folder. If you created a project, a link to it is also established in My Folder.

If you created a project or auxiliary file using default settings, you can always change the settings later.



For information on changing file settings, refer to the “Assigning Auxiliary Files to a Project” section later in this chapter.

When you create a new file, the following dialog box is displayed:

You can use this dialog box to define the following settings:

- **File Type** — The type of file to create: Project, Calendar, Resource, or Code
- **Name** — The name for the file
- **Description** — The description for the file
- **Use previous settings as defaults** — Selecting this option instructs Open Plan to create the new file using the settings from the last time you created a new file. This setting is disabled for Calendars and Codes.

Clicking **Next** will take you to the first page of the **New File Wizard**. Clicking **Finish** creates the file using default settings. If you do not select the **Use previous settings as defaults** option and then click **Finish**, the file is created using Open Plan defaults.



For more information on using the **New File Wizard**, refer to Chapter 4, “Creating a New File.”

To create a new project or auxiliary file

1. Display the **New File** dialog box by taking one of the following actions:
 - On the toolbar, click the **New** button.
 - Press **Ctrl+N**.
 - On the **File** menu, click **New**.
 - Double-click an empty area of the Open Plan Explorer.
2. In the **New File** dialog box, select the type of file to create.
3. Provide a name and description for the file
4. Take one of the following actions:
 - To define your own settings for the file, click **Next** to start the **New File Wizard**.
 - To create the file using default settings, select the **Use previous settings as defaults** option ,and click **Finish**.
 - To create the file using Open Plan default settings, click **Finish**.



New button

Saving Files

Open Plan allows you to save a file with its current name using the **Save** command or under a different name using the **Save As** command. These commands are available as follows:

- If you opened the file in **Exclusive** mode, you can use the **Save** or **Save As** command at any time.
- If you opened a file in **Shared** mode, the **Save** command is not available. To save the project under a different name, use the **Save As** command. (Normally, Open Plan saves your changes to project, code, resource, and calendar files opened in **Shared** mode as you make them.)



For more information about working with files opened in **Shared** mode, refer to Chapter 24, “System Utilities.”

- If you opened the file in **Read Only** mode, the **Save** command is not available. You must use the **Save As** command to save the file under a different name before you can make any changes to it.

When you click **Save As** on the **File** menu command, Open Plan displays the following dialog box:

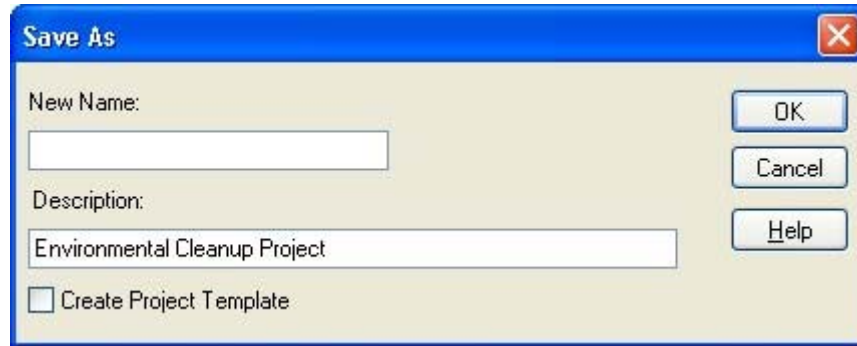

With this dialog box, you can save project and data files to your database.

Depending on the circumstances under which you perform the **Save As**, the following rules apply:

- When you create a copy of a project, the new project maintains the same auxiliary file attachments as in the original project.
- When you create a copy of an auxiliary file, if you want a project to use the new file, you must attach it to the project by either dragging it from the Open Plan Library and dropping it on the project or by using the **Files** tab of the **Project Properties** dialog box.



You cannot perform **Save As** on a file if there is another file open which refers to it. For example, if you open project CLEAN and then try to perform a **Save As** on the calendar file CLEANCAL, you are given the following warning: "Cannot perform Save As on Calendar File CLEANCAL because there are open objects referring to it." Since CLEAN refers to CLEANCAL, you need to close the project before you can perform **Save As** on CLEANCAL.

To use the Save command

1. Take one of the following actions:
 - On the **File** menu, click **Save**.
 - Press **Ctrl+S**.
 - On the toolbar, click the **Save** button.



To use the Save As command

1. On the **File** menu, click **Save As**.
2. Enter a name for the file.
3. Click **OK**.

Closing Files

The operation performed when you issue a **Close** command depends on what method you use and the context in which you issue the command. There are four methods for performing the **Close** command:

- Clicking **Close** on the **File** menu
- Clicking **Close** on a context menu
- Clicking the **Close** button located in the upper-right corner of a window
- Clicking **Close** on the **Control Menu** located in the upper-left corner of a window



You cannot close a file if another file is dependent on it. For example, assume you have the resource view displayed for an open project. If you close the project without first closing the resource view, the project and its auxiliary files will close except for the resource file. The resource file remains open because the resource view is dependent on it.

The following sections describe each of the above methods.

Clicking Close on the File Menu

- In an activity data view, such as a barchart or spreadsheet view, clicking **Close** on the **File** menu closes the project.
- Selecting an open auxiliary file and clicking **Close** on the **File** menu closes the file. (This is assuming that there is not another open file, such as a project or view, dependent on the auxiliary file.)
- For a project selected in the hierarchy pane of the Open Plan Explorer, clicking **Close** on the **File** menu closes the project.

Clicking Close on a Context Menu

Right-clicking an open file in the Open Plan Explorer and clicking **Close** on the context menu that is displayed performs the same operation as clicking **Close** on the **File** menu.

Clicking the Close Button

The close button is located in the upper-right corner of a window:

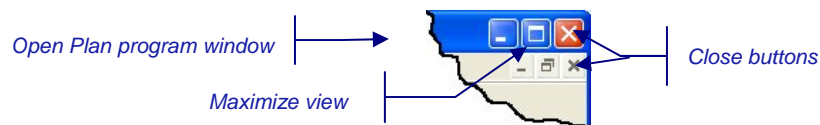

- Clicking the **Close** button for a view closes that view but leaves the project open.
- Clicking the **Close** button for the Open Plan Explorer closes the Explorer but does not close any open projects.



If you accidentally close the Open Plan Explorer, you can redisplay it by clicking **Open Plan Explorer** on the **View** menu.



Control Menu
icon for views
and Open Plan
Explorer



Control Menu
icon for Open
Plan
Professional

- Clicking the **Close** button for Open Plan closes the program. You are prompted for confirmation before the program closes.

Clicking Close on the Control Menu

- Clicking Close on the Control Menu located in the upper-left corner of a view closes that view but leaves the project open.
- Clicking Close on the Control Menu for the Open Plan Explorer closes the Explorer but does not close any open projects.



If you accidentally close the Open Plan Explorer, you can redisplay it by clicking **Open Plan Explorer** on the **View** menu.

- Clicking **Close** on the **Control Menu** for Open Plan closes the program.



Pressing **Ctrl+F4** performs the same function as clicking **Close** on the **Control Menu** for views and the Open Plan Explorer. Pressing **Alt+F4** performs the same function as clicking **Close** on the **Control Menu** for Open Plan.

Assigning Auxiliary Files to a Project

As stated in the previous section, when you create a file, you have the option of using the **New File Wizard** to define your own settings for the file. In the case of a project, this also includes assigning auxiliary files. On the other hand, if you create the project using Open Plan defaults, only the default calendar is assigned to the project.

There are two ways to assign auxiliary files to an existing project (or change previously assigned files):

- Edit the **Project Properties** dialog box
- Use drag and drop

You can use the **Files** tab of the **Project Properties** dialog box to assign calendar, resource definition, and code files:

The screenshot shows the 'Project Properties' dialog box with the 'Files' tab selected. The 'Project Name' field contains 'CLEAN' and the 'Description' field contains 'Environmental Cleanup Project'. Under 'Calendar File', the field contains 'CLEANCAL'. Under 'Resource Definition File', the field contains 'CLEANRES'. Under 'Code Files', there are two entries: 'Code1: OBS (CLEAN OBS - Cleanup OBS)' and 'Code2: WBS (CLEAN WBS - Cleanup WBS)'. The dialog has 'OK', 'Cancel', and 'Help' buttons at the bottom right.

Clicking the **ellipsis** button next to a field displays a list of available files from which to choose. For example, clicking the calendar **ellipsis** displays a list of all available calendar files:

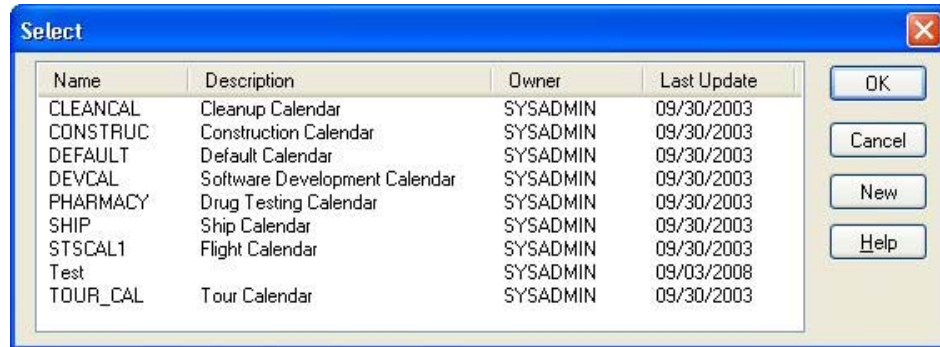

You also have the option of creating a new file. Clicking **New** displays the **New File** dialog box.



For more information on creating a new file, refer to the “Creating a New Project or Auxiliary File” section in this chapter.

Dragging an auxiliary file from the appropriate folder of the Open Plan Library and dropping it into a project folder automatically assigns the file to the project. Only one calendar file and one resource definition file can be assigned to a project at a time. If you drag a calendar or resource definition file from the Open Plan Library to a project that already contains one of these files, Open Plan asks if you would like to replace the existing file.



A project cannot be dragged onto itself.

When a resource definition file is assigned to a project, a link to the file is displayed in a project subfolder that has the same name as the resource file.

When a one or more code files are assigned to a project, links to these files are displayed in a project subfolder named codes.

When a calendar file is assigned to a project, a link to that file is displayed in the project’s root folder.

To assign an auxiliary file using the Project Properties dialog box

1. Open the project in **Exclusive** mode to which you want to assign an auxiliary file.
2. Take one of the following actions:
 - On the **Project** menu, click **Properties**.
 - Right-click the project folder, and click **Properties** on the context menu.
3. On the **Project Properties** dialog box, click the **Files** tab.
4. Use the **ellipsis** buttons to select the auxiliary files.
5. When finished, click **OK**.

To assign an auxiliary file using drag and drop

1. In the Open Plan Library, locate the auxiliary file you want to assign to a project.
2. Drag and drop the file into the target project folder.
3. If the project already contains a calendar or resource definition file, click **Yes** when Open Plan asks if you want to replace the existing file.



When using drag and drop, it is not necessary to first open the target project. The project is automatically opened when the auxiliary file is dropped into it.

Assigning Views to a Project

View files are stored in the Views folder of the Open Plan Library. To assign a view to a project, you can either drag it from the Library to the project folder or double-click it in the Library to display the **Choose a Project** dialog box.



For more information on views and the **Choose a Project** dialog box, refer to Chapter 17, “Views and Reports.”

To assign a view using drag and drop

1. In the Views folder of the Open Plan Library, locate the view file you want to assign to a project.
2. Drag and drop the file into the target project folder.



When using drag and drop, it is not necessary to first open the target project.

To assign a view using the Choose a Project dialog box



The project to which you want to add the view must be open for this method to work.

1. In the Views folder of the Open Plan Library, double-click the view file you want to assign to the project.
2. From the **Choose a Project** dialog box, select the open project for which to display the view.
3. Take one of the following actions:
 - To display the view without creating a link, clear the **Make a Permanent Link to Project** setting.
 - To create a link to the project, select the **Make a Permanent Link to Project** setting.
4. Click **OK**.

Creating a Shortcut

You can easily create a shortcut to a Windows application, file, or URL in any of the following Open Plan folders:

- The first level of My Folder
- The Startup folder
- Any user-created folder

Placing a shortcut in the Startup folder automatically launches it when you start Open Plan. For example, if you want Windows Notepad to automatically start when Open Plan starts, you would place a shortcut to Windows Notepad in the Startup folder. Open Plan also allows you to edit the properties of a shortcut using a **Properties** dialog box.

You can suppress the automatic loading of items in the Startup folder by holding down the **Ctrl** key after launching Open Plan.



For information on displaying and using the **Properties** dialog box for a shortcut, refer to Chapter 24, "System Utilities."

To create a shortcut using Copy and Paste

1. In the Windows Explorer, locate and select the appropriate file.
2. Take one of the following actions:
 - On the Windows Explorer **Edit** menu, click **Copy**.
 - Press **Ctrl+C**.
3. In the Open Plan Explorer, select the folder in which to create the shortcut.
4. Take one of the following actions:
 - On the **Edit** menu, click **Paste**.
 - Press **Ctrl+V**.

Open Plan creates the shortcut in the designated folder.

To create an application shortcut using Drag and Drop



In order for this operation to work, you must be able to view both the Open Plan Explorer and the Windows Explorer at the same time. You can easily do this by starting both programs and then right-clicking the Windows Taskbar and clicking **Tile Windows Horizontally** (or **Vertically**).

1. In the Windows Explorer, locate and select the application.
2. Drag the application and drop it in the target Open Plan folder.

Open Plan creates the application shortcut in the designated folder.



You can copy Windows Desktop Shortcuts to Open Plan by selecting the shortcut and either using the Cut/Paste or Drag/Drop method described above. You can also drag the icon preceding the URL name in the Address Bar of Internet Explore to the desired user created folder.

Deleting Files

There are two ways to delete a file:

- By selecting the file and pressing the **Delete** key
- By using the **Select File to Delete** dialog box

There is a third way to perform a deletion that pertains only to views — right-click a view and click **Delete** on the context menu.



You cannot delete a file that is open, referenced by another file, or to which you do not have the appropriate rights.

When you use the **Delete** key to delete a file, Open Plan interprets the deletion depending on where the file is located in the hierarchical view.

Codes that are assigned to projects cannot be deleted from the projects using this method. Codes are removed from projects using the **Files** tab of the **Project Properties** dialog box.



For more information on removing codes from projects, refer to the “Using Code Files” section of Chapter 11, “Project Codes.”

My Folder — If you delete a file from within this folder, Open Plan only deletes the link you created to the file. In the case of a project, the project link as well as the auxiliary files links are deleted. No actual data is deleted from the data source.



To quickly delete a project link from this folder, right-click the project, and click **Delete Link** on the context menu.

Projects — If you delete a project from within this folder, the project data and all the links to auxiliary files and views are deleted. Deleting just an auxiliary file or view deletes the link to the file. No actual auxiliary file or view data is deleted from the data source.

Open Plan Library — If you delete an auxiliary file or view from within this folder, the actual data is deleted from the data source.

To delete a file

1. Select the file, and press the **Delete** key.
2. When Open Plan asks you to confirm the deletion, click **Yes**.

Pointing to **Manage Files** on the **File** menu and clicking **Delete File** displays the **Select File to Delete** dialog box that you can use to delete a file from the data source.

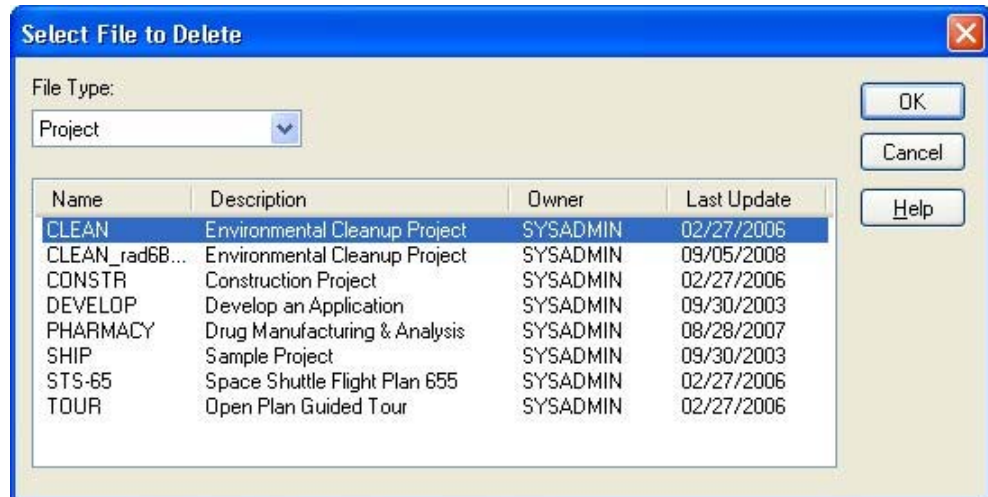

This dialog box displays a list of files based on the type of file you select in the **File Type** field.



It is possible to select multiple files to delete at once by using either **Shift**+click or **Ctrl**+click to make your selection.

Also, depending on the file type, Open Plan performs one of the following actions when you delete a file:

- If the file is a project, all the project data is deleted from the data source. The links created in the Project folder to any auxiliary files are removed, but the auxiliary file data itself is not deleted. Any links to the project in your My Folder are also removed.
- If the file is a calendar, resource, or code file, the file's data is deleted from the data source and any links to it in other folders.

To delete a file using the Delete key

1. From the appropriate folder, select the file to delete.
2. Press the **Delete** key.
3. When Open Plan asks you to confirm the deletion, click **Yes**.

To delete a data file using the Select File to Delete dialog box

1. On the **File** menu, point to **Manage Files**.
2. On the **Manage Files** submenu, click **Delete File**.
3. Select the file you want to delete, and click **OK**.
4. When Open Plan asks you to confirm the deletion, click **Yes**.

Filtering the Contents of the Display Format

The Open Plan Explorer provides a command for filtering the contents of the **Details** format. You can use this option, for example, to filter out all completed projects or all views that are not barcharts from contents pane.

The **Filter** option is available for the following folders:

- Projects
- Calendars
- Codes
- Resources
- Views
- Briefcase



For folders that cannot be filtered, this option is disabled or not listed.

Selecting a folder and clicking **Filter** on the **View** menu or right-clicking the folder and clicking **Filter** on the context menu invokes the **Filter Settings** dialog box:

Use this dialog box to define the following settings:

- **Enable Filtering** — Selecting this option applies the filter folder.
- **Field Name** — This setting lists all the fields on which you can filter. These fields are the headings displayed in the **Details** format.
- **Operator** — This setting lists the logical operators used in the filter definition. These operators are:
 - Contains
 - Equals
 - Gr. Or Equals
 - Greater than
 - Is Empty
 - Less or Equals
 - Less than
 - Not Contains
 - Not Empty
 - Not equals



The **Contains** operator is case-sensitive. Criteria entered using this expression must be typed in the same case as the original value. If the same case is not used, no results will be displayed.

- **Criteria** — This setting allows you to enter a value for comparison to the **Field Name** as defined by the **Operator**. This setting is text sensitive.
- **Clear** — Removes all values that have been entered in the dialog box.

To filter the contents of the display format

1. In the hierarchical pane, select the folder to filter.
2. Take one of the following actions:
 - Select the folder to filter, and click **Filter** on the **Views** menu.
 - Right-click the folder to filter, and click **Filter** on the context menu.
3. In the **Filter Settings** dialog box, define the filter, and select **Enable Filtering**.
4. Click **OK**



The filter you define is only applied to the selected folder. This means that you can have a different filter for each folder if you so desire.

Using Find

The **Find** dialog box allows you to find an object in any subfolder of the folder that is currently selected. You can search for an object based on its name or on any field that is available in the **Details** format. Since this dialog box is modeless, you can keep it open while you initiate any number of searches.

Clicking **Find** on the **Edit** menu displays the following dialog box:

Name	In Folder	Type

Use this dialog box to define the following search parameters:

- **Search For** — The type of object to find. Selecting **<All Objects>** instructs Open Plan to perform a complete search of all object types (that is, calendars, resources, projects, etc.).
- **Named** — Use of this field is optional. If you enter the name of the object to find, Open Plan will find all objects that match the name entered or that begin with the name entered. For example, if you are searching for the

project named CLEAN, Open Plan will respond with all projects that begin with the name CLEAN.



If you do not know the entire name of the object for which you are searching, you can enter the first few letters of the name. Be aware, though, that you must provide the beginning letters of the name. Open Plan does not search for text embedded within the name. For example, if you enter LEAN, Open Plan will not find CLEAN.

- **Where** — Use of these fields is optional. The three **Where** fields allow you to apply a filter to your search criteria:
 - The first field contains a list of data fields based on the type of object selected in the **Search For** field.
 - The second field contains a list of the following logical operators that you can use to further define the filter:
 - Equal to
 - Greater than
 - Less than
 - Not equal to
 - The third field allows you to enter a value to compare against.



The **Where** fields are not available when **<All Objects>** is selected in the **Search For** field.

- **Look In** — This field allows you to specify the folder in which Open Plan should start the search. By default, the selected folder in the hierarchical pane is displayed in this field. However, you can also select **<All Folders>**, **My Folder**, **Projects**, and **Open Plan Library** from the list. Open Plan also facilitates your search by displaying any subfolders that have been opened during the current session.



Since the **Find** dialog box is modeless, an alternative to using the **Look In** field is to simply select the folder to search from the hierarchical pane while the dialog box is displayed.

- **Include subfolders** — Selecting this option instructs Open Plan to include all subfolders of the currently selected folder in the search.

Once the search criteria is defined, clicking **Find Now** performs the search. Open Plan displays the name, location, and file type for each object it finds matching the search criteria.

If you would like to perform another search, click **New Search** to clear the **Named** and **Where** fields.

To search for an object using the Find dialog box

1. On the **Edit** menu, click **Find**.
2. In the **Find** dialog box, define the search criteria for the object to want to find.

3. Click **Find Now**.
4. To close the dialog box, click **Cancel**.

4

Creating a New File

➤ Overview	79
➤ Creating a File with Default Settings.....	80
➤ Creating a File with Custom Settings.....	81
➤ Using the New File Wizard.....	84

Overview

Open Plan allows you to create new project, calendar, resource definition, and code files with one of following methods:

- Using default settings
- Using the **New File Wizard** where you can define custom settings for the file



Regardless of the method you use to create the file, you can always change the settings later using the **Properties** dialog box for the file.

This chapter begins with a description of how to create a new file with default settings, continues with a discussion of how to create a file with custom settings, and ends with a detailed description of the **New File Wizard**.

Creating a File with Default Settings

The starting point for creating any type of Open Plan file is the **New File** dialog box.



You can create a file using Open Plan default settings or you can create the file using the settings from the last file you created. If you are creating a project or resource file, the **Use previous settings as defaults** option allows you to use the settings from the last project or resource file you created.

If you want to create a file with Open Plan default settings, you have only to select a **File Type** (project, calendar, resource, or code), enter a **Name** for the file, and click **Finish**. To use the settings from the last file created, be sure to select the **Use previous settings as defaults** option before clicking **Finish**.



While most project managers will enter a **Description** for the file, this field is not required.

To display the New File dialog box

1. Take one of the following actions:
 - On the **File** menu, click **New**.
 - Press **Ctrl+N**.
 - On the toolbar, click the **New** button.
 - Double-click an empty area of the Open Plan Explorer.



New button

Creating a File with Custom Settings

The **New File Wizard** in Open Plan helps you to specify custom settings for a new file as it is being created. Once you have entered the information in the **New File** dialog box (as described in the previous section), you can start the **New File Wizard** by clicking **Next**.

The **New File Wizard** contains a total of nine pages. The type of file (project, calendar, resource, or code) you create determines which pages are displayed during the process. A brief overview of each page follows:

- **Create** — This page of the wizard is displayed for all files you create. You can use the **Create** page to specify whether you want to create a new blank file or create a file as a copy of another.
- **Summary** — This page of the wizard is displayed only when you are creating a project or multiproject. You can use the **Summary** page to enter summary information about the project.
- **Status Information** — This page of the wizard is displayed only when you are creating a project or multiproject. You can use the **Status Information** page to enter status information about the project.
- **Files** — This page of the wizard is displayed when you are creating a project, multiproject, or a resource file. You can use the **Files** page to select the auxiliary files that the project or resource file will use. If the auxiliary file you want to use does not yet exist, you can also create it “on the fly” by displaying the **New File** dialog box from this page.
- **External Subprojects** — This page of the wizard is displayed only when you are creating a multiproject. You can use the **External Subprojects** page to select the external subprojects to be included in the new multiproject project.
- **Preferences** — This page of the wizard is displayed only when you are creating a project or multiproject. You can use the **Preferences** page to define the default preferences for the project.
- **Code Structure** — This page of the wizard is displayed only when you are creating a code file. You can use the **Code Structure** page to define the structure of a code file.
- **Notes** — This page of the wizard is displayed when you create a project, multiproject, resource, or code file. You can use the **Notes** page to attach a note to the file.
- **Access Control** — This page of the wizard is displayed for all files you create. You can use the **Access Control** page to define the access rights that groups or individual users with a specified role will have to the file you are creating.

After you have created your new file, Open Plan saves the setting choices you made on the pages in the **New File Wizard**. The next time you create a file, you have the option of using these saved settings as the default settings for the new file.

The following chart summarizes the circumstances under which each page of the **New File Wizard** is displayed:

Wizard Page	Project	Multiproject	Calendar	Resource	Code
Create	✓	✓	✓	✓	✓
Summary	✓	✓			
Status Information	✓	✓			
Files	✓	✓		✓	
External Subproject		✓			
Preferences	✓	✓			
Code Structure					✓
Notes	✓	✓		✓	✓
Access Control	✓	✓	✓	✓	✓



For detailed information about each page of the wizard, refer to the corresponding sections later in this chapter.

To create a file with custom settings

1. Display the **New File** dialog box.
2. From the **File Type** field, select the appropriate file type (project, calendar, resource, or code).
3. In the **Name** field, enter a name for the new file.
4. In the **Description** field, enter a description for the file. (This step is optional.)
5. Click **Next**.
6. Open Plan starts the **New File Wizard** and displays the **Create** page.
7. If the **Default Access Mode** field is displayed on this page, select a default access mode for the file.



If you are creating a new project, the **Default Access Mode** field is displayed on the **Preferences** page of the wizard.

8. Decide whether you want to create an original new file or create the file as a copy of an existing one, and click the appropriate option.
9. If you are creating the new file as a copy of an existing one, Open Plan allows you to select the file that you want to use as a template.
10. If the **Startup View** field is displayed on this page, you may select the view that you would like Open Plan to display when the file is opened.



If you are creating a new project, the **Startup View** field is displayed on the **Preferences** page of the wizard.

11. Complete the remaining pages of the wizard, clicking **Next** to advance from page to page.
12. On the last page of the wizard, click **Finish**.
13. Open Plan creates the file with the information you entered. If you have created a project, Open Plan places it in the Projects folder and creates a link to the project in your My Folder. If you have created a calendar, resource, or code file, Open Plan places it within the appropriate folder in the Open Plan Library.



When you have finished creating the file, you can display the relevant **Properties** dialog box to review your settings and make any necessary changes.

Using the New File Wizard

The following fields are located at the top of each page of the **New File Wizard**:

- **Name** — The name of the file as it was entered on the **New File** dialog box is displayed at the top of each page. You can change this name only on the **Create** page of the wizard.
- **Owner** — Your user ID is displayed in this field. As the owner of the file, only you or the security administrator can assign access rights to the file to other users.
- **Description** — The description of the file is displayed in this field. While this description may have been entered on the **New File** dialog box, it may also be entered or changed on any page of the wizard.

Buttons located along the bottom of each page allow you to navigate through the series of pages available for the type of file you are creating.



You can also click the **Finish** button at any time during the wizard process to create the new file using the settings you have defined to that point. It is not necessary to complete all pages of the wizard as you can always define the remaining settings on the **Properties** dialog box for the file.

New File Wizard — Create Page

The **Create** page of the wizard is used for all types of files. When you click **Next** on the **New File** dialog box, this page is displayed automatically:

You can use the **Create** page to specify the following parameters for the new file:

Default Access Mode — This field is displayed only when you are creating an auxiliary (resource, calendar, or code) file.



If you are creating a project, the **Default Access Mode** field is displayed on the **Preferences** page of the wizard.

The setting you choose determines the default access mode when the file is opened. The three access modes are:

- **Exclusive** — A file opened in **Exclusive** mode can only be opened in **Read Only** mode by other users. When you have a file open in **Exclusive** mode, you can save any changes you make. You can also close the file without saving your changes.
- **Shared** — Only available in the Professional edition of Open Plan, this mode allows two or more users to access a file and work with the data at the same time. When you have a file open in **Shared** mode, any changes that you make to the file are automatically saved as soon as they are made. This provides all users who have the file open with the latest information
- **Read Only** — This mode allows you to view a file. You cannot, however, make any changes to the file while you have it open in this mode.



For more information on the three access modes, refer to Chapter 24, “System Utilities.”

- **Auxiliary Files** — This field is displayed only when you are creating a resource file. It controls the default access mode of the auxiliary files attached to the resource file.

The following options control how Open Plan should create the new file:

- **Create a new file** — Selecting this option instructs Open Plan to create a new blank file.



A user with system administrator rights can disable this option by selecting the **Create New Projects Using Default Project** on the **Project** tab of the **Options** dialog box.

- **Create a new file as a copy of an existing file** — If you select this option, the wizard enables a list of files of the appropriate type that are currently stored in the database. You must use this list to select the file to be used as a template.



When creating a project, if you choose to use a master project as the template, Open Plan prompts you to open the external subprojects. If you open these external subprojects, they will become internal subprojects in the new project. If you prefer to keep them as external subprojects, do not open them.

- **Startup View** — This field is displayed only when you are creating an auxiliary (resource, calendar, or code) file. The setting you choose determines the view that Open Plan automatically displays when the file is opened.



If you are creating a project, the **Startup View** field is displayed on the **Preferences** page of the wizard.

New File Wizard — Summary Page

The **Summary** page of the **New File Wizard** is displayed only when you are creating a project or multiproject:

This page allows you to enter the following summary information about the new project:

- **Project Manager** — The name of the project manager. While use of this field is optional, the information it contains is used in many reports.
- **Project Manager Email Address** — The project manager's email address. While use of this field is optional, Open Plan can use the information it contains as the "To" address in the **Email Advisor**.
- **Company** — Your company name.
- **Client** — The project's client.
- **Project Priority** — Specifies the priority of the project. Open Plan uses this setting when performing resource scheduling on a number of projects at one time. You can give the project a high priority by entering a low numeric value.
- **Create Summary Usage Upon Saving Project** — Selecting this option instructs Open Plan to populate the Project Summary Usage (PSU) table when the project is saved. Open Plan uses this data when performing resource scheduling on a number of projects at one time.
- **Create Summary Usage Based On** — This field is enabled when you select the **Create Summary Usage Upon Saving Project** option. It allows you to specify the type of dates (early, late, or scheduled) that Open Plan should use when creating the summary usage data.

New File Wizard — Status Information

The **Status Information** page of the **New File Wizard** is used only when you are creating a project or multiproject:

The screenshot shows the 'New File Wizard - Status Information' dialog box. The fields are as follows:

- Name:** Test Project
- Owner:** SYSADMIN
- Description:** This is a test project file.
- Project Start:** [Empty text box with an ellipsis button]
- Time Now:** [Empty text box with an ellipsis button]
- Auto Time Analysis:** [Unchecked checkbox]
- Finish Type:** None (dropdown menu)
- Target Finish:** [Empty text box with an ellipsis button]
- Target Cost:** 0

Buttons at the bottom: < Back, Next >, Finish, Cancel, Help.

You can use this page to enter the following status information for the project:

- **Project Start** — The date on which the project starts. You can specify the **Project Start** either by entering the date directly or by clicking the **ellipsis** at the right edge of the field and selecting a date from the calendar that is displayed.
- **Time Now** — The original status date for the project. You can specify **Time Now** either by entering the date directly or by clicking the **ellipsis** at the right edge of the field and selecting a date from the calendar that is displayed.
- **Auto Time Analysis** — If you select this option, Open Plan will perform time analysis each time the data in the project changes.
- **Finish Type** — You can use this field to specify the type of target Open Plan should use when a **Target Finish** is set. You can select from the following **Finish Types**:
 - None
 - Not Earlier Than
 - Not Later Than
 - On Target
- **Target Finish** — This field is enabled only if you have selected one of the target types in the **Finish Type** field. If enabled, you can impose a finish date on the project either by entering the date directly or by clicking the **ellipsis** at the right edge of the field and selecting a date from the calendar that is displayed.

The target finish date affects the dates that the program calculates when performing time analysis or resource scheduling. Entering this date is optional. Ordinarily, you will want to give Open Plan as much flexibility as possible in its calculations by not setting a project target finish date.

- **Target Cost** — The target cost for the project.

New File Wizard — Files Page

The **Files** page of the **New File Wizard** is displayed only when you are creating a project, multiproject, or resource file. This page allows you to assign auxiliary files to the file you are creating:

The fields that are displayed on this page depend on the type of file you are creating.

- **Calendar File** — This field is displayed when you are creating a project, multiproject, or resource file. You can assign a single calendar file to the file you are creating. The way in which this calendar is used depends on the type of file you are creating:
 - If you are creating a project or multiproject, the calendar you select is used as the default calendar for project calculations.
 - If you are creating a resource file, the calendar you select is used as the default calendar when defining resource availabilities.
- **Resource Definition File** — This field is displayed only when you are creating a project or multiproject. You can use this field to assign a single resource definition file to the project.
- **Code Files** — This field is displayed when you are creating a project, multiproject, or resource file. You can assign up to 90 code files to the file you are creating.

Assigning Calendar and Resource Definition Files

Clicking the **ellipsis** button next to the **Calendar File** or **Resource Definition File** field displays a **Select** dialog box from which you can select the auxiliary file. For example, if you click the **ellipsis** button next to the **Calendar File** field, the **Select** dialog box that is displayed contains a list of all available calendar files in the database:

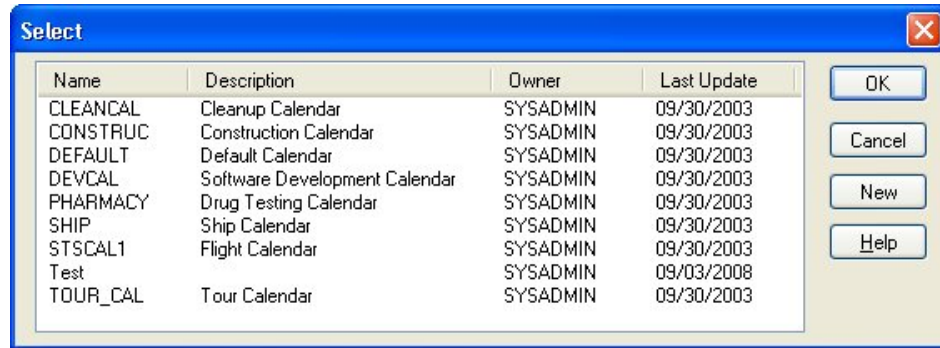

You can also create a new calendar or resource file by clicking **New** on the **Select** dialog box. Doing so displays the **New File** dialog box with the type of file you are creating automatically selected in the **File Type** field. You can then choose to create the file using Open Plan default settings, or you can start a new instance of the **New File Wizard**.

Once it is created, the new auxiliary file is automatically added to the **Select** dialog box.

To assign an existing calendar or resource file

1. On the **New File Wizard — Files** page, click the **ellipses** button next to the appropriate field.
2. From the **Select** dialog box, select the auxiliary file.
3. Click **OK**.

To create a new calendar or resource file

1. On the **New File Wizard — Files** page, click the **ellipses** button next to the Calendar or Resource field.
2. On the **Select** dialog box, click **New**.

Open Plan displays the **New File** dialog box. After creating the new file, it is added automatically to the **Select** dialog box.

Assigning Code Files

Clicking the **ellipsis** button next to the **Code Files** field displays the **Assign Code** dialog box:

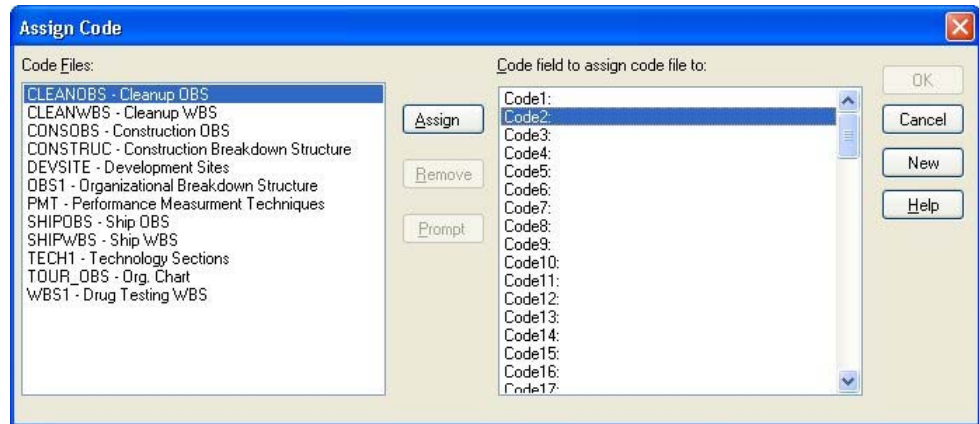

This dialog box allows you to assign code files for up to 90 code fields in the Project Directory, or Activity or Resource tables. Select a code file from the left pane and then select a field to assign it to in the right pane.

Each time you click **OK** to assign the selected code to the selected field, Open Plan displays the **Code File Prompt** dialog box:



This dialog box allows you to change the prompt text for the code file before assigning it to the code field.



If the code has default prompt text defined (on the **Properties** dialog box for the code file), it is automatically entered when the **Code File Prompt** dialog box is displayed. If no prompt text has been defined for the code, the code file name is automatically entered on the dialog box. The code prompt is used instead of the generic field name (C1...C90) in any field list that is brought up in a specific context. For example, if "OBS" is the code prompt for C1 in Project Clean, that is what you will see when you select fields in an activity spreadsheet view opened under CLEAN. C1...C90 will appear in dialogs that are not opened under a specific context (such as the Calculated Fields Dialog).

Once you have entered the prompt text and clicked **OK**, Open Plan assigns it to the code file. You can change the prompt text by selecting the code in the right pane of the **Assign Code** dialog box and clicking **Prompt** to display the **Code File Prompt** dialog box again.

Code files are stored as either a rotated column or as a permanent column in the code's associated table.

Rotated columns do not take up space in the database unless they are assigned values; assigned values are stored as records. When the records are accessed,

they are “rotated” logically into the more familiar field structures. This method reduces the amount of database storage used when a code column is used sparsely, but may increase the amount of time needed to load and save data, especially if a column of data is densely populated.

Non-rotated columns require database storage even when there is no value for a particular record, but reduce loading and saving times.

If a code index (e.g., Code 1, Code 2, Code 3, etc. in the graphic above) does not currently have a rotated column assigned to it, then a user has the option of either creating a new column as a rotated or non-rotated column. The process of assigning codes can be performed when creating or changing properties for an Open Plan project.

Only users who have system administrator rights may make changes to the structure of a database table. That means that anyone attempting to make structural changes will be prompted to log in as the System Administrator. The user will be prompted for this login even if he is currently logged in as the System Administrator.

To assign code files to the Project Directory, or the Activity or Resource tables

1. On the **New File Wizard — Files** tab, click the **ellipses** button next to the **Code Files** field.
2. In the **Assign Code** dialog box, assign a code file to a code field.
3. In the **Code File Prompt** dialog box, you may change the name for the code file prompt.
4. Repeat steps 2 and 3 as many times as necessary. You can assign code files for up to 90 code fields.
5. To return to the wizard, click **OK**.
6. If you have assigned a code to a code field (e.g., Index 90) that has not been previously used, you will be prompted with the following dialog box when you click **Finish**:

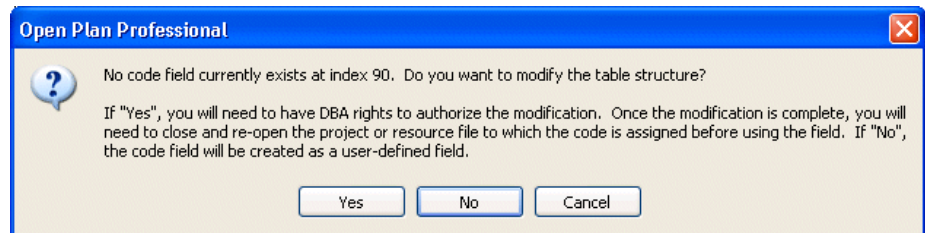

7. If you select **No** (the default button), the code field is created as a rotated column. (Note: If you select **Yes**, you will be prompted to log in as a system administrator.) If you select **Yes**, the code field is created as a non-rotated column.

To change the code file prompt for an assigned code file

1. On the **New File Wizard — Files** page, click the **ellipses** button next to the **Code Files** field.
2. From the right pane of the **Assign Code** dialog box, select a code file.
3. Click **Prompt**.

4. Open Plan displays the **Code File Prompt** dialog box.
5. Enter a new prompt for the code file, and click **OK**.
6. To return to the **New File Wizard — Files** page, click **OK**.

New File Wizard — External Subprojects

The **External Subprojects** page of the **New File Wizard** is displayed only when you are creating a multiproject:

The screenshot shows the 'New File Wizard - External Subprojects' dialog box. It features a title bar with a close button. The main area contains the following elements:

- Name:** Test Master
- Owner:** SYSADMIN
- Description:** This is a test multiproject file.
- Select External Subprojects to Include in New Project:**
 - CLEAN - Environmental Cleanup Project** (selected)
 - CLEAN_rad6BF7F - Environmental Cleanup Project
 - CONSTR - Construction Project
 - DEVELOP - Develop an Application
 - PHARMACY - Drug Manufacturing & Analysis
 - SHIP - Sample Project
 - STS-65 - Space Shuttle Flight Plan 655
 - TOUR - Open Plan Guided Tour
- Buttons:** < Back, Next >, Finish, Cancel, Help

This page allows you to select the external subprojects to include in the multiproject. The text box on this page displays a list of all the projects currently stored in the database.

By default, the project(s) that were selected when you displayed the context menu from the Open Plan Explorer are preselected in this list. You can, however, add or remove selections in this list simply by clicking them. The selected projects become external subprojects in the multiproject that is created when you click **Finish**.

To create a new multiproject

1. Right-click a project in the Open Plan Explorer, and click **Create Multiproject** on the context menu.
2. In the **New File** dialog box, enter a name and description for the multiproject.
3. **Project** is automatically selected for the **File Type**, and the field is disabled.
4. Click **Next** to start the **New File Wizard**.
5. Complete the pages of the wizard as needed.

The **External Subproject** page is the fourth page of the wizard.

New File Wizard — Preferences

The **Preferences** page of the **New File Wizard** is used only when you are creating a project or multiproject:

This page allows you to specify the following default project settings:

- **Default Date Format** — You can use this field to specify the default format that Open Plan should use for this project when displaying dates. For new projects, the default format is 31Dec07. However, you can choose from many other formats as well. If you later enter a date in a different format, Open Plan attempts to convert it to the format you selected as the default.

For example, if your default date format is 31Dec07, Open Plan makes the following conversions:

 - 31dec is interpreted as 31Dec07 if 2007 is the current year.
 - 13/12/07 is always interpreted as December 13, 2007, since 13 cannot be interpreted as a month.
 - If the date you enter is all numeric (for example, 10/01/07), Open Plan uses the order of month and year from your Windows system.
- **Default Activity Type** — You can use this field to select the activity type that Open Plan assigns to new activities within the project. You can select from the following activity types: ASAP, ALAP, Start Milestone, Finish Milestone, Discontinuous, Hammock, and Effort Driven. In addition, you can also select External Subproject.
- **Def. Activity Calendar** — You can use this field to select the default calendar to be used for all new activities within the project. Using a default activity calendar makes it easier to share one calendar file over all projects.
- **Default Res. Curve** — You can use this field to choose from the following:
 - All valid Spread Curves defined within the Spread Curve dialog box for which the user has at least read-only access; or
 - A blank curve type

By default, Default Res. Curve is blank. The Default Res. Curve value is used for all new resource assignments within the project. The Default Res. Curve option is available when using Backup or Save As.

- **Startup View** — You can select the view that Open Plan should display by default when opening the project.
- **Def. Relationship Calendar** — You can use this field to select the default calendar Open Plan should use for all new relationships within the project.
- **Default Res. Level** — The Default Res. Level field contains the following options:
 - **0** — Sets the default resource level for new resource assignments to 0.
 - **1** — Sets the default resource level for new resource assignments to 1.
 - **First availability** — The default resource level for new resource assignments is obtained from the first resource availability that is defined for the assigned resource. If the Resource does not have any defined availability, the default resource level will be set to 1.

By default, Default Res. Level is set to First Availability. The Default Res. Level value will be used for all new resource assignments within the project.

The warning **The resource level for this assignment is 0.0 Do you want to continue?** is displayed if:

- The resource assignment is a new (unsaved) resource assignment;
- The Default Resource Level option is set to '0' (zero); and
- The resource Level of the resource assignment is '0' (zero).

The Default Res. Level option is included in Backup and Save As.

- **Conversions** — You can use these fields to specify the way Open Plan should convert durations into minutes from different time units:
 - per Day – Controls the number of hours and minutes per day that are used in the conversion. The default setting is 8 hours and 0 minutes.
 - per Week – Controls the number of hours and minutes per week that are used in the conversion. Typically, this would be the number of hours per day multiplied by the number of work days in a week. The default setting is 40 hours and 0 minutes.
 - per Month – Controls the number of hours and minutes per month that are used in the conversion. Typically, this would be the number of hours per day multiplied by the number of work days in a month. The default setting is 160 hours and 0 minutes.
- **Default Duration Units** — By specifying a default duration unit, you can enter durations in the project without specifying a unit. You can specify any of the following units: Minutes, Hours, Days, Weeks, or Months.
- **Min. Calculated Duration** — You can use this field to specify the minimum duration unit that Open Plan should use in calculations for the project.



Calculated durations include those generated while stretching a bar in the barchart view.

- **Default Access Mode** — You can use these fields to select which of three access modes Open Plan should use by default for the project and its auxiliary files. The three access modes are:
 - **Exclusive** — A file opened in **Exclusive** mode can only be opened in **Read Only** mode by other users. When you have a file open in **Exclusive** mode, you can save any changes you make. You can also close the file without saving your changes.
 - **Shared** — Only available in the Professional edition of Open Plan, this mode allows two or more users to access a file and work with the data at the same time. When you have a file open in **Shared** mode, any changes that you make to the file are automatically saved as soon as they are made. This provides all users who have the file open with the latest information
 - **Read Only** — This mode allows you to view the project or auxiliary file. You cannot, however, make any changes to the file while you have it open in this mode.



For more information on the three access modes, refer to Chapter 24, "System Utilities."

New File Wizard — Code Structure

The **Code Structure** page of the **New File Wizard** is used only when you are creating a code file:

You can use this page to define the structure of the new code file:

- **Code Type** — Open Plan supports two types of code file structures:

- **Punctuated Significant** — With this type of code, Open Plan uses a period (.) to separate the part of the code that corresponds to the different levels in the structure.
- **Fixed Format Significant** — With this type of code, the length of the code represents the structure level. Apart from the top-level code, each code is based on the name of its parent.
- **Fixed Level Length** — If you select the **Fixed Format Significant** code type, Open Plan enables the following controls:
 - **Levels 1 through 10** — While Open Plan allows you to define up to 10 levels for the fixed level length, most planners find that 3 or 4 levels are all they need.

At each level, you can define the number of characters that will be used. The number you enter is cumulative.

The following example assumes that three levels have been defined in the code file:

Level	Code Length	Example
Level 1	2	DV
Level 2	5	DV215
Level 3	7	DV21535

Note that the code at Level 2 includes the code of its parent, and that although the code length is defined as 5, only 3 new characters (215) are added to the code.

Similarly, the code at Level 3 includes the code of its parent, and although the code length is defined as 7, only 2 new characters (35) are added to the code.

- **Pad Character** — The character specified as the pad character is used as a suffix to codes that do not use the defined length at a given level.

The following example assumes that three levels have been defined in the code file and that the pad character is "0":

Level	Code Length	Local Portion of Code	Code Example
Level 1	2	DV	DV
Level 2	5	9	DV900
Level 3	6	A	DV900A

Note that only a single character is entered in the local portion of the code at Level 2 but that the cumulative code length is defined as 5. Open Plan pads the code out to the required length by adding two 0s as a suffix to the local portion of the code.



You can use any character (including a space) as a pad character.

New File Wizard — Notes

The **Notes** page of the **New File Wizard** is used when creating a project, multiproject, resource file, or code file:

You can use the following fields to attach a note to the file:

- **Note** — This text box can contain up to 29 KB of text. You can enter the text by typing directly in this field or by using the Windows **Cut (Ctrl+X)**, **Copy (Ctrl+C)**, and **Paste (Ctrl+V)** commands to insert text from another Windows application such as a word processor or spreadsheet.
- **Category** — This field controls the category of the note. You can select a category from the list of global categories.

Clicking the **abc** button checks the spelling of the text you enter.

You can enter links to files, Web pages, and e-mail addresses by entering the information in one of the following formats:

- File links must be entered in the format of: [file://c:\document.doc](#)



If the file link you enter contains spaces, you must enclose the link with angle brackets (< >) in order for the link to work properly: **<file://C:\Documents and Settings\All Users\Desktop\test.txt>**

- Universal Resource Locators (URLs) must be entered in the format of: [http://deltek.com](#)
- E-mail addresses must be entered in the format of: [mailto:sales@deltek.com](#)



While you can use drag and drop functionality to create links in the **Note** field, the Windows **Cut (Ctrl+X)**, **Copy (Ctrl+C)**, and **Paste (Ctrl+V)** commands are not available for links.

To enter a note while creating a file

1. From the **Category** list, select a category for the note.
2. Use one of the following methods for entering a note in the **Note** pane:

- Type your message directly in the pane.
 - Use the **Cut**, **Copy**, and **Paste** commands to insert text in the pane from another Windows application such as a word processor or spreadsheet.
3. If desired, click the **abc** button to check the spelling in your note.

New File Wizard — Access Control

The **Access Control** page of the **New File Wizard** is used when creating all types of files:

You can use this page to specify access rights that groups and individual users with a specified role have to the file.

The following fields are available:

- **Group** — By selecting a field in this column and selecting a group from the list, you can specify the groups that can have access to the file.
- **Role** — When you select a group or user ID, its default role is automatically entered in this field. You can then change default role to any role that has been defined in the data source.
- **User ID** — You can specify individual users who can access the file.



The **Group** and **User ID** settings are mutually exclusive. In other words, you cannot specify a group and an individual user on the same row of the grid. You can, however, give access rights to a group on one row and then give access rights to an individual on a separate row.

- **Read Only** — Setting this option to **Yes** limits the rights of the group or user to viewing the file. No changes can be made to the file. Setting this option to **No** gives the group or user all rights to the file that are permitted by the assigned role.



The security options for groups and roles are assigned using the Security Administrator.

To specify access rights for a group

1. In the **Group** column, select an empty cell/row, and select a group from the list.
2. In the **Role** column, select a role for the group from the list.
3. In the **Read Only** column, use the list to select **Yes** or **No**.



Notice that the **User ID** column is left blank.

To specify access rights for an individual user

1. In the **User ID** column, select an empty cell/row, and select a user ID from the list.
2. In the **Role** column, select a role for the user ID from the list.
3. In the **Read Only** column, use the list to select **Yes** or **No**.



Notice that the **Group** column is left blank.

5

File Properties

➤ Overview	103
➤ Auxiliary File and View Properties Tabs	104
➤ Project Properties Tabs.....	115

Overview

Each type of file in Open Plan has an associated tabbed **Properties** dialog box. For resource files, code files, calendar files, and views, the dialog box is called the **Properties – <Filename>** dialog box, where **<Filename>** is the name of the selected file. For a project, it is called the **Project Properties** dialog box.

Many of the tabs on these dialog boxes are identical in function. Some are unique to that file. This chapter begins with descriptions of the tabs located on the **Properties** dialog boxes for auxiliary files and views. Since the **Project Properties** dialog box contains many unique tabs and has only five tabs in common with auxiliary files and views, it will be discussed separately at the end of this chapter.

Auxiliary File and View Properties Tabs

The following table lists all the tabs found on the **Properties** dialog box for auxiliary and view files. It also indicates the type of file on which the tab can be found.

Properties Tab	Resource Files	Code Files	Calendar Files	View Files
General	✓	✓	✓	✓
Statistics	✓			
Files	✓			
Access Control	✓	✓	✓	✓
Open Status	✓	✓	✓	
References	✓	✓	✓	
Notes	✓	✓		
User Fields	✓	✓		
Structure		✓		
Preferences				✓

Each tab, regardless of the file, displays the following information:

- **Name** — This field displays the name given to the file at its creation.
- **Owner** — This field displays the ID of the current owner of the file. Under normal circumstances, the owner of the file or view is the person who created it. While other users may have the rights to modify many of its properties, only the owner or the system administrator can transfer the ownership of the object.
- **Description** — This field displays the description of the file. Providing a description is optional during file creation. You can edit the description on any tab of the **Properties** dialog box.

Editing Considerations

- When editing the properties for a file, the following guidelines should be taken into consideration:
- Provided you have the proper access control rights to the file, you do not have to first open a file to edit its properties.
- The **Files** tab for a resource file is only enabled when the file is opened in **Exclusive** mode.
- A view does not have to be open to edit its properties.
- Opening a resource, code, or calendar file in **Read Only** mode disables all the fields in the **Properties** dialog box.

To display the Properties dialog box for a resource, code, or calendar file

1. Take one of the following actions.

- In the Open Plan Explorer, right-click the appropriate file, and click **Properties** on the context menu.
- Open the appropriate file, and click **Properties** on the **Edit** menu.
- Open the appropriate file, right-click an empty area of the workspace, and click **Properties** on the context menu.

To display the Properties dialog box for a view file

1. In the **Open Plan Explorer**, locate the appropriate view file.
2. Right-click the view file, and click **Properties** on the context menu.

The General Tab



For the sake of consistency, the **Properties** dialog box for a resource file will be used to illustrate the various tabs. Differences on the tabs among the various file types are clearly noted.

The **General** tab of the **Properties** dialog box is available for resource, code, calendar, and view files. It displays the following information about the file:

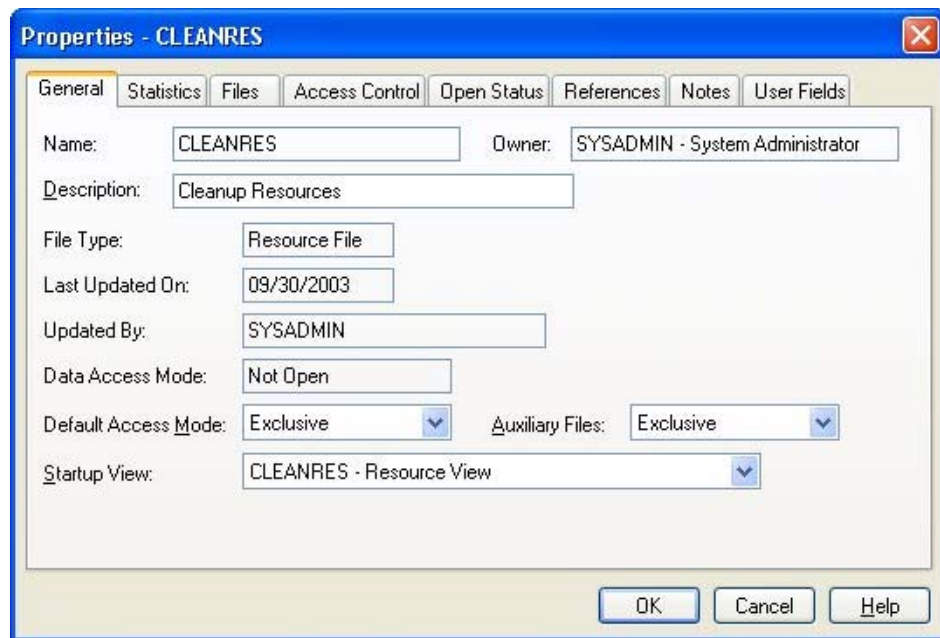

This tab of the dialog box displays the following information:

- **File Type** — Indicates whether the file is a code file, resource file, calendar file, or view template
- **Last Updated On** — Displays the date on which the file or view was last updated
- **Updated By** — Displays the user ID of the person who last updated the file or view
- **Data Access Mode** — Displays the current data access mode:
 - Not open

- Exclusive
- Shared
- Read-only

 This field is not displayed for a view.

- **Default Access Mode** — Controls the default access mode (**Exclusive**, **Shared**, or **Read Only**) of the file

 This field is not displayed for a view.

- **Auxiliary Files** — Controls the default access mode (**Exclusive**, **Shared**, or **Read Only**) of the auxiliary files attached to the resource file

 This field is displayed only for resource files.

- **Startup View** — Controls the view that Open Plan should display by default for the auxiliary file

 This field is not displayed for a view.

- **Default Prompt Text** — Controls the default prompt text that is automatically entered on the **Code File Prompt** dialog box that displays when you attach a code file to a project or resource file. Although this text is entered by default, you can change it before clicking **OK** on the **Code File Prompt** dialog box.

 This field is displayed only for code files.

The Statistics Tab

The **Statistics** tab of the **Properties** dialog box is displayed only for resource files:

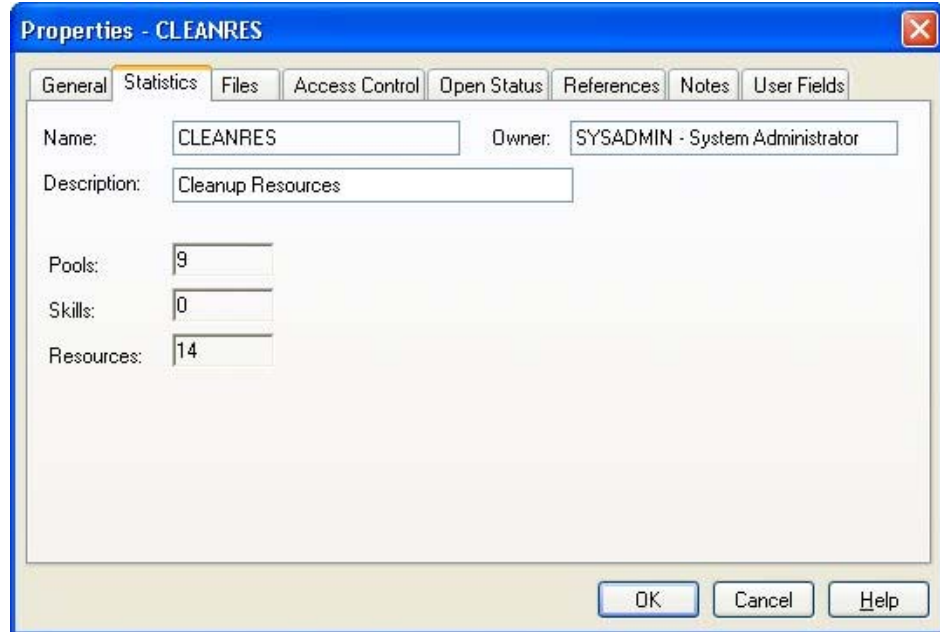

This dialog box displays the following settings:

- **Pools** — The total number of pools in the resource file
- **Skills** — The total number of skills in the resource file
- **Resources** — The total number of individual resources in the resource file



Resources with the type Pool are not included in this total.

The Files Tab

The **Files** tab of the **Properties** dialog box is displayed only for resource files. It allows you to attach a calendar and a code file to the resource file:

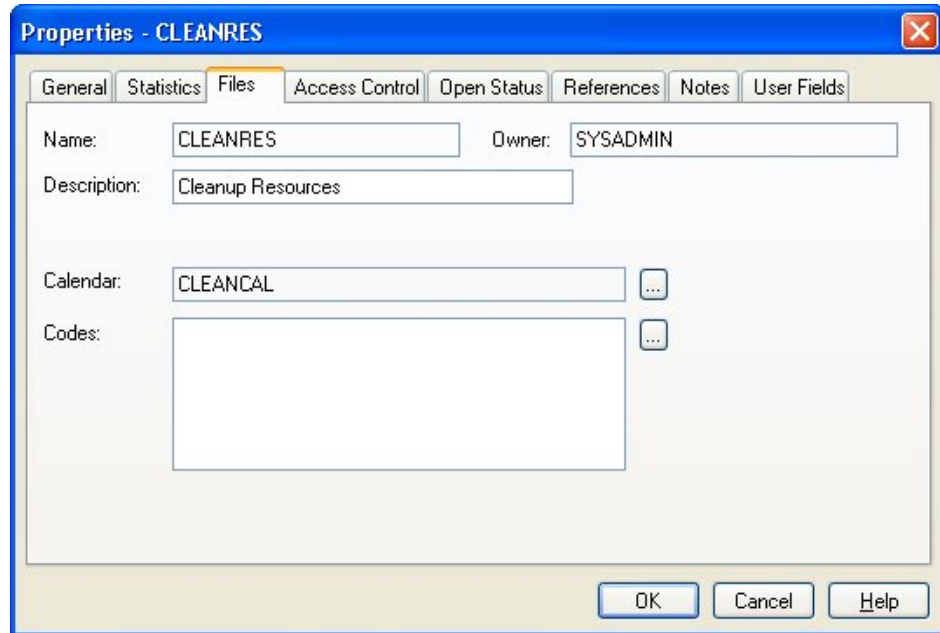

This dialog box has the following controls:

- **Calendar** — Controls the calendar file attached to the resource file.
 When you click the **ellipsis** button at the right edge of this field, Open Plan displays the **Select** dialog box that you can use to assign a calendar file to the resource file.
- **Codes** — Controls the code files attached to the resource file.
 When you click the **ellipsis** button at the right edge of this field, Open Plan displays the **Assign Code** dialog box that you can use to assign codes to up to 90 code fields on the resource file.



For more information on using the **Select** dialog box and the **Assign Code** dialog box to assign calendar file and code files, refer to the “New File Wizard — Files Page” section of Chapter 4, Creating a New File.”

The Access Control Tab

The **Access Control** tab of the **Properties** dialog box is available for resource, code, calendar, and view files. It allows you to define the access rights that users or groups have and what role they have to the file:

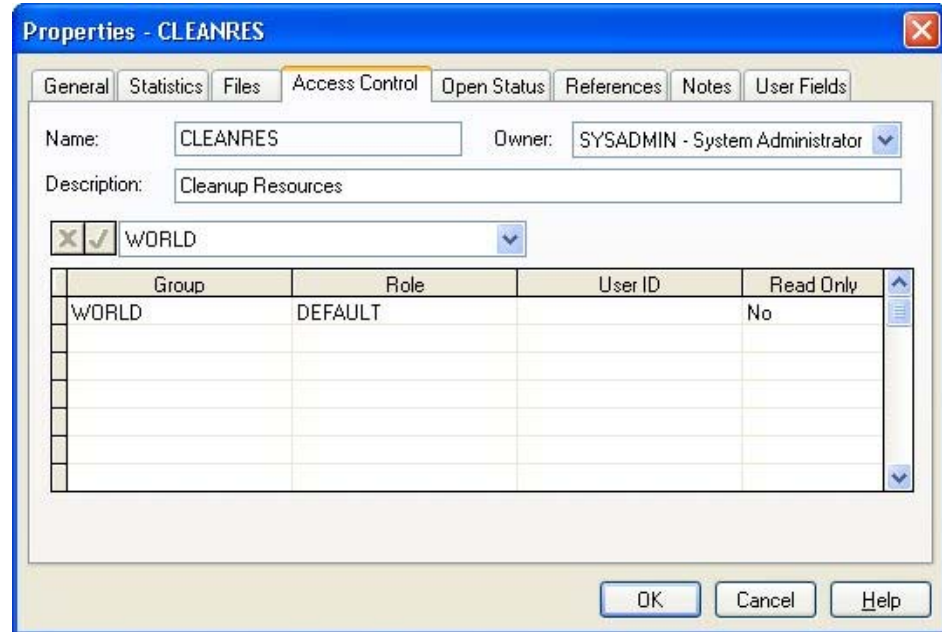

If you are the owner of the project or a member of the System Administrator group, you can use the following fields to define access rights to the file:

- **Owner** — You can change the owner of the file by selecting a new owner from the list.
- **Group** — By selecting a field in this column and selecting a group from the list, you can specify the group(s) that can have access to the file.
- **Role** — When you select a group or user ID, its default role is automatically entered in this field. You can then change default role to any role that has been defined in the data source.
- **User ID** — By selecting a field in this column and selecting a user ID from the list, you can specify the users that can have access to the file.
- **Read Only** — By selecting **Yes** for this field, you limit the group or user to opening the file in **Read Only** mode. By selecting **No** for this field, other users may open the file in any mode they choose. **Read Only** mode has the following limitations:
 - In order to make changes to the file, you must first save it under a different name.
 - You cannot see changes made by other users.



In order to see changes made by other users who may have the file open in **Exclusive** or **Shared** mode, you have to close and reopen the file.

The Open Status Tab

The **Open Status** tab of the **Properties** dialog box is available for resource, code, and calendar files. It displays the information about the open status of the project:

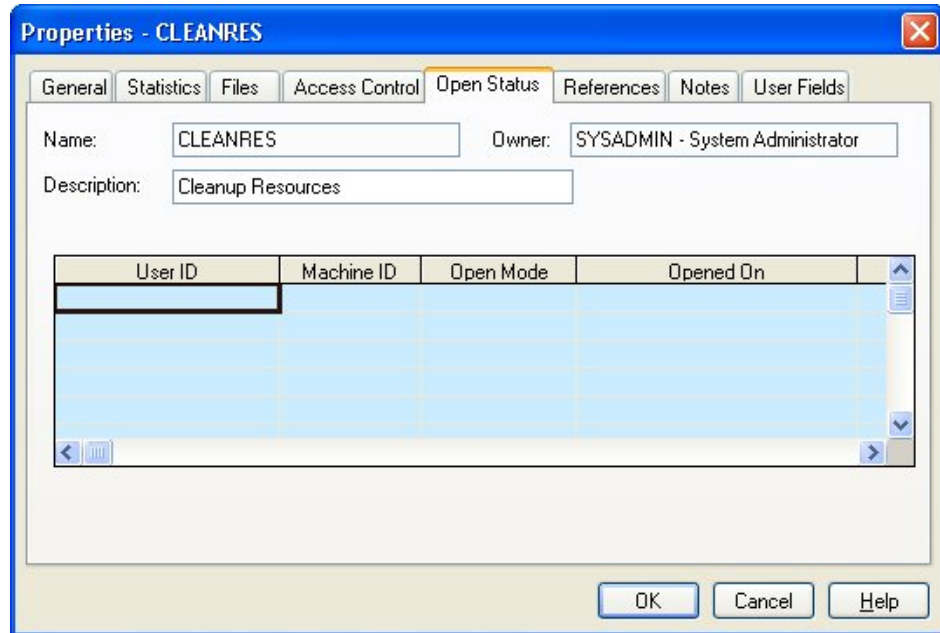

The following information is displayed on this tab:

- **User ID** — Displays the user ID of each person who has the project open
- **Machine ID** — Displays the ID of each computer where the file is open
- **Open Mode** — Displays the mode in which the project is open. This mode can be any of the following:
 - **Exclusive** — If a file is open in **Exclusive** mode, you have the exclusive right to make changes to it. While you have the file open in exclusive mode, other users can open the file only in **Read Only** mode.
 - **Shared** — If the file is open in **Shared** mode, other users can open the file and make changes while you have it open.
 - **Read Only** — If the file is open in **Read Only** mode, you cannot use the **Save** command to save any changes you may make. Instead, you must use the **Save As** command and save the file with a different name.



For more information on the three access modes, refer to Chapter 24, "System Utilities."

- **Opened On** — Displays the date and time that the file was opened by a user

The References Tab

The **References** tab of the **Properties** dialog box is available for resource, code, and calendar files:

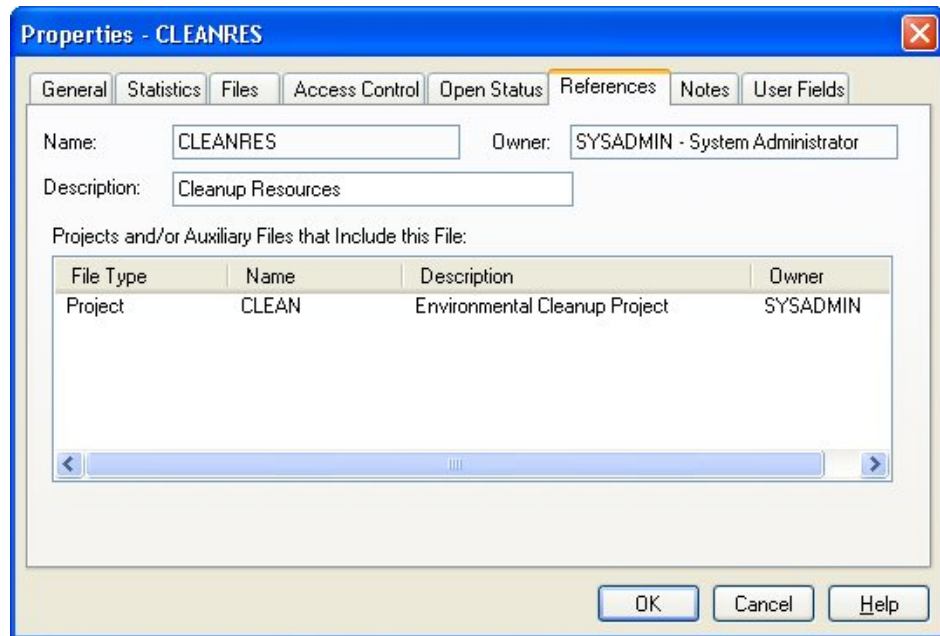

Every file that references the selected auxiliary file is listed on this dialog box.

The Notes Tab

The **Notes** tab of the **Properties** dialog box is available for resource and code. You can use this tab to attach text information to the file:

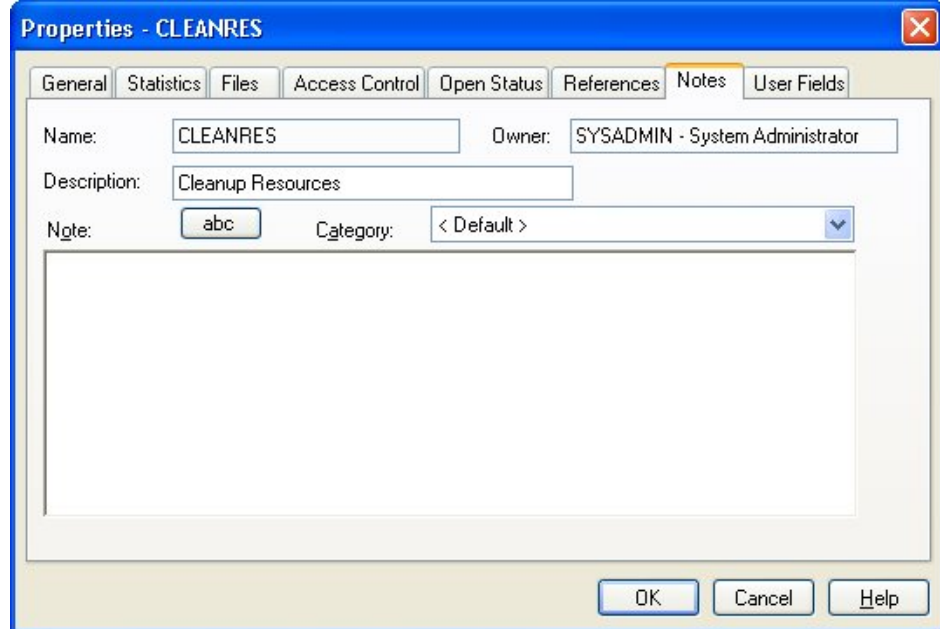

You can use the following fields to attach a note to the file:

- **Note** — This text box can contain up to 29 KB of text. You can enter the text by typing directly in this field or by using the Windows **Cut (Ctrl+X)**, **Copy (Ctrl+C)**, and **Paste (Ctrl+V)** commands to insert text from another Windows application such as a word processor or spreadsheet.

- **Category** — This field controls the category of the note. You can select a category from the list of global categories.

Clicking the **abc** button checks the spelling of the text you enter.

You can enter links to files, Web pages, and e-mail addresses by entering the information in one of the following formats:

- File links must be entered in the format of: <file://c:\document.doc>



If the file link you enter contains spaces, you must enclose the link with angle brackets (< >) in order for the link to work properly: **<file://C:\Documents and Settings\All Users\Desktop\test.txt>**

- Universal Resource Locators (URLs) must be entered in the format of: <http://deltek.com>
- E-mail addresses must be entered in the format of: <mailto:sales@deltek.com>



While you can use drag and drop functionality to create links in the **Note** field, the Windows **Cut (Ctrl+X)**, **Copy (Ctrl+C)**, and **Paste (Ctrl+V)** commands are not available for links.

The User Fields Tab

The **User Fields** tab of the **Properties** dialog box is available for resource and code files. It allows you to specify the values that Open Plan should include for user-defined fields.



User-defined fields are created on the appropriate table outside of an open file and may be used by any file stored in the database. In order to use a user-defined field in your file, you must specify a value for it on this tab.

Properties - CLEANRES

General Statistics Files Access Control Open Status References Notes User Fields

Name: CLEANRES Owner: SYSADMIN - System Administrator

Description: Cleanup Resources

Field	Value
-------	-------

OK Cancel Help

The **User Fields** tab features a grid containing two columns:

- **Field** — This column displays a list of all the user-defined fields that have been defined for the appropriate table.
- **Value** — For each user-defined field that you want to use in your file, you should enter an appropriate value.



For information on creating user-defined fields, refer to Chapter 23, “Project Utilities.”

The Structure Tab

The **Structure** tab of the **Properties** dialog box is available only for code files:

The screenshot shows the 'Properties - CLEANOBS' dialog box with the 'Structure' tab active. The 'Name' field is 'CLEANOBS' and the 'Owner' is 'SYSADMIN - System Administrator'. The 'Description' is 'Cleanup OBS'. In the 'Code Type' section, 'Fixed Format Significant' is selected. In the 'Fixed Level Length' section, 'Level 1' is set to 5, and 'Level 2' through 'Level 10' are all set to 0. The 'Pad Character' field is empty. The 'OK', 'Cancel', and 'Help' buttons are visible at the bottom.

This dialog box displays the following information for the code file:

- **Code Type** — Open Plan supports two types of code file structures:
 - **Punctuated Significant** – Open Plan uses a punctuation character to separate the part of the code that corresponds to the different levels in the structure.
 - **Fixed Format Significant** – The length of the code represents the structure level. Apart from the top-level code, each code is based on the name of its parent.
- **Fixed Level Length** — These fields contain data only when the code type is **Fixed Format Significant**. While Open Plan allows up to 10 levels for the fixed level length, in most cases, only 3 or 4 levels are used.

For each level that is used, Open Plan displays the number of characters that are specified. This number is cumulative.

- **Pad Character** — The character specified as the pad character is used as a suffix to codes that do not use the defined length at a given level. Any character (including a space) can be used as a pad character.



For more information on code structures, refer to Chapter 11, “Project Codes.”

The Preferences Tab

The **Preferences** tab of the **Properties** dialog box is available only for views files:

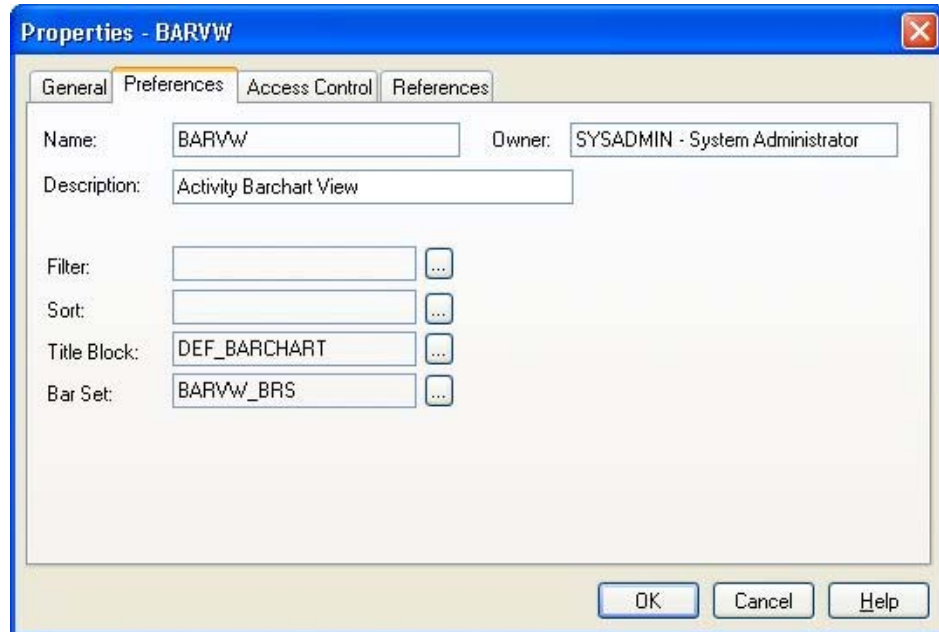

You can use this tab to define the settings for the following fields.



Depending on the type of view selected, one or more of the fields may be enabled. When a field is enabled, an **ellipsis** button is displayed at the right edge of the field.

- **Filter** — This field allows you to apply a filter to the view. Clicking the **ellipsis** at the right edge of the field displays the **Filters** dialog box that you can use to select a filter. You can also use that dialog box to create, edit, or modify filters.
- **Sort** — This field allows you to sort the data in the view. Clicking the **ellipsis** at the right edge of the field displays the **Sorts** dialog box that you can use to select a sort. You can also use that dialog box to create, edit, or modify sorts.
- **Title Block** — This field allows you to apply a title block to the view. Clicking the **ellipsis** at the right edge of the field displays the **Title Blocks** dialog box that you can use to select a title block. You can also use that dialog box to create, edit, or modify title blocks.
- **Bar Set** — This field allows you to select a bar set to be displayed on the view. Clicking the **ellipsis** at the right edge of the field displays the **Bar Sets** dialog box that you can use to select the bar set. You can also use that dialog box to create, edit, or modify bar sets.

Project Properties Tabs

The **Project Properties** dialog box allows you to view and enter project-level information at any time. Most of the settings found on the various tabs of the **Project Properties** dialog box can be entered initially when you use the **New File Wizard** to create a new project. However, if you use Open Plan default settings when you create a new project, you can later customize the settings using the **Project Properties** dialog box.

The **Project Properties** dialog box has the following tabs:



The project **Files**, **Access Control**, **Open Status**, **Notes**, and **User Fields** tabs function similarly to those described earlier.

- **Summary** — Displays basic information about the project
- **Preferences** — Allows you to set a number of preferences that determine how Open Plan should display and process project data
- **Files** — Allows you to display and assign the calendar, resource, and code file assignments for a project
- **Status** — Displays information about project status
- **Cost** — Displays summary cost information for the project
- **Notes** — Allows you to attach text information to the project
- **Scheduling** — Allows you to specify both the project's priority and the type of dates that should be used when calculating the resource usage summary
- **User Fields** — Allows you to specify the values that Open Plan should include for user-defined fields on the Project table
- **Access Control** — Allows you to define the access rights that users who are members of a group with a specified role have to the project
- **Open Status** — Displays the information about the open status of the project
- **Codes** — Allows you to assign codes to the project
- **References** — Displays master projects that include this project as an external project.

The following fields are located at the top of each tab:

- **Project Name** — The name of the project is established during project creation. You cannot edit the name of the project.



Provided that you have the project open in **Exclusive** or **Shared** mode, you can use the **Save As** command to create a copy of the project by saving it under a different name.

- **Description** — Providing a project description is optional during project creation. You can edit the project description on any tab of the **Project Properties** dialog box.

The Summary Tab

The **Summary** tab displays basic information about the project:

Along with the name and description of the project, the top of the tab displays the following information:

- **Owner** — This field displays the ID of the current owner of the project. In most cases, this is the person who created the project.
- **Data Access Mode** — This field identifies the mode in which the project is open:
 - **Exclusive** — A file opened in **Exclusive** mode can only be opened in **Read Only** mode by other users. When you have a file open in **Exclusive** mode, you can save any changes you make. You can also close the file without saving your changes.
 - **Shared** — Only available in the Professional edition of Open Plan, this mode allows two or more users to access a file and work with the data at the same time. When you have a file open in **Shared** mode, any changes that you make to the file are automatically saved as soon as they are made. This provides all users who have the file open with the latest information.
 - **Read Only** — This mode allows you to view a file. You cannot, however, make any changes to the file while you have it open in this mode. You must first save the project under a different name before you can make any changes.
- **Project Phase** — This field indicates the phase at which the project currently stands. There are three phase categories:
 - **Proposed** — The project proposal has been submitted and is awaiting approval.
 - **Open** — The project has been approved. Although the project phase is open, the actual project may not necessarily have started as yet.



To check the current status of the project, display the **Status** tab of the **Project Properties** dialog box.

- **Closed** — The project has been completed.

The lower-left section of the tab controls the following general purpose information:

- **Project Manager** — Enter the name of the project manager in this field. While use of this field is optional, the information it contains is used in many reports.
- **Project Manager Email Address** — Enter the project manager's email address in this field. While use of this field is optional, Open Plan can use the information it contains as the "To" address in the **Email Advisor**.
- **Company** — Enter the name of company managing the project in this field. While use of this field is optional, the information it contains is used in many reports.
- **Client** — Enter the name of the project's client in this field. While use of this field is optional, the information it contains is used in many reports.

The **Project Statistics** section of the tab displays the following statistical information:

- **Total Activities** —The total number of activities within the project.



Total Activities does not include the activities in any open external subprojects.

- **Total In Progress** — The total number of activities in the project with a status of **In Progress**. This value is updated only when time analysis is performed.
- **Total Complete** — The total number of activities within the project that are complete. This value is updated only when time analysis is performed.
- **Total Relationships** — The total number of relationships within the project.
- **Total Assignments** — The total number of resource assignments within the project.

If the project contains open external subprojects, the totals displayed include values from activities within the external subprojects.

When the project contains unopened external subprojects, Open Plan includes in the totals the external subproject activities acting as place holders but not the activities that are within the unopened subprojects.

The lower-right section of the tab features the following baseline controls:

- **Baselines** — Open Plan can display up to three project baselines in these fields. You can change any of these baselines by clicking **Select Baseline** and selecting a different baseline from the dialog box that is displayed.
- **Select Baseline** — Clicking this button displays a dialog box that you can use to select up to three baselines for the project. In addition, you can use this dialog box to create, update, and delete project baselines.



For more information on managing baselines, refer to Chapter 16, "Status Information."

The Preferences Tab

The **Preferences** tab allows you to set a number of preferences that determine how Open Plan should display and process project data:

Use this tab to enter any of the following project preferences:

- **Default Date Format** — This option controls the default format Open Plan uses for dates. For new projects, the default format is 31Dec07. However, you can select from many other formats as well – most of which are predetermined, with two originating from the international settings of Windows.

If you later enter a date in a different format, Open Plan attempts to convert it to the format you selected as the default.

For example, if your default date format is 31Dec07, Open Plan makes the following conversions:

- 31dec is interpreted as 31Dec07 if 2007 is the current year.
- 13/12/07 is always interpreted as December 13, 2007 since 13 cannot be interpreted as a month.

If the date you enter is all numeric (for example, 10/01/07), Open Plan uses the order of month and year from your Windows Regional Options.

- **Default Activity Type** — You can define the default type for new activities as one of the following:
 - ASAP
 - ALAP
 - Start Milestone
 - Finish Milestone
 - Discontinuous
 - Subproject
 - Hammock
 - Effort Driven
 - External Subproject (not available in the Desktop edition of Open Plan)



For a description of these activity types, refer to Chapter 6, “Activity Information.”

- **Def. Activity Calendar** — The default calendar is used for all new activities within the project. Using a default activity calendar makes it easier to share one calendar file over all projects.
- **Default Res. Curve** —The Default Res. Curve field displays the following choices:
 - All valid Spread Curves defined within the Spread Curve dialog box for which the user has at least read-only access
 - A blank curve type

By default, Default Res. Curve is blank. The Default Res. Curve value is used for all new resource assignments within the project. The Default Res. Curve option is available when using Backup or Save As.

- **Startup View** — Open Plan automatically displays the selected startup view whenever you open the project.
- **Def. Relationship Calendar** — The default calendar for all new relationships within the project.
- **Default Res. Level** — The Default Res. Level field contains the following options:
 - **0** — Sets the default resource level for new resource assignments to 0.
 - **1** — Sets the default resource level for new resource assignments to 1.
 - **First availability** — The default resource level for new resource assignments is obtained from the first resource availability that is defined for the assigned resource. If the Resource does not have any defined availability, the default resource level will be set to 1.

By default, Default Res. Level is set to First Availability. The Default Res. Level value will be used for all new resource assignments within the project.

The warning **The resource level for this assignment is 0.0 Do you want to continue?** is displayed if:

- The resource assignment is a new (unsaved) resource assignment;
- The Default Resource Level option is set to '0' (zero); and
- The resource Level of the resource assignment is '0' (zero).

The Default Res. Level option is included in Backup and Save As.

- **Conversions** — Three settings control the way in which Open Plan converts durations into minutes from different time units:
 - **Per Day** — Controls the number of hours and minutes per day that are used in the conversion. The default setting is 8 hours and 0 minutes.
 - **Per Week** — Controls the number of hours and minutes per week that are used in the conversion. Typically, this would be the number of hours per day multiplied by the number of work days in a week. The default setting is 40 hours and 0 minutes.
 - **Per Month** — Controls the number of hours and minutes per month that are used in the conversion. Typically, this would be the number of hours per day multiplied by the number of work days in a month. The default setting is 160 hours and 0 minutes.

Open Plan calculates the number of hours available for work in any given duration by referring to the applicable project calendar.



For information about the use of calendars to define working times, refer to Chapter 9, “Project Calendars.”

- **Durations** — You can define the following settings for durations:
 - **Default Units** — You can define a default duration unit for entering activity durations. For example, if you set the default duration unit as days, an activity duration of 10 will be interpreted by Open Plan as a duration of 10 days.
 - **Min. Calculated** — You can indicate a minimum time unit that Open Plan should use when calculating durations in time analysis. For example, if you define the minimum calculated duration as days, Open Plan will never calculate activity durations in units smaller than one day during time analysis (except in cases where the user-defined duration for the activity is less than a day). This setting is intended to allow you to improve processing times for very large networks at the expense of decreased precision in the scheduling calculations. Whether or not this approach yields acceptable results depends on a number of factors. For example, if your project extends over a number of years, minor inaccuracies in the schedule of events occurring several years in the future may not be significant.



It is important to remember that specifying a minimum calculated duration that is smaller than your shortest activity duration does not improve scheduling accuracy. For example, if you schedule all of your activities in days, specifying an hour as the minimum calculated duration will not produce a more accurate schedule.

- **Default Access Mode** — The Desktop edition of Open Plan supports two access modes:
 - **Exclusive** — If a file is open in **Exclusive** mode, you have the exclusive right to make changes to it. While you have the file open in exclusive mode, other users can open the file only in **Read Only** mode.
 - **Read Only** — If the file is open in **Read Only** mode, you must use the **Save As** command in order to save any changes you may make.

The Professional edition of Open Plan also features the **Shared** mode. If the file is open in **Shared** mode, multiple users can have access to the file at the same time. Open Plan saves the data whenever a user clicks **OK** on a dialog box that uses the shared file.



For more information on the three access modes, refer to Chapter 24, “System Utilities.”

In either edition of Open Plan, you can override the **Default Access Mode** settings by opening the project using one of the following procedures.

- On the **File** menu, click **Open**, and select the appropriate access mode from the **File Open** dialog box.
- From Open Plan Explorer, right-click the file, point to **Open** on the context menu, and select the appropriate access mode.



If you open an auxiliary file outside the context of a project, right-clicking the file and clicking **Default** on the **Open** submenu opens the auxiliary file in the default access mode established on the **Properties** dialog box for that file.

- **Earned Value** — You can specify the Earned Value Technique (EVT) that Open Plan automatically assigns to a new activity. When the Base Physical Percent Complete on EVT option is selected on the Progress Calculations dialog box, Open Plan uses the selected EVT to update the earned value of the activities when progress calculations are run.



You can override this default EVT for an activity by assigning a new EVT to the activity using the Advanced tab of the Activity Details dialog box.

You can choose from the following EVT:

- Level of Effort
- Percent Complete
- 50-50
- 0-100
- 100-0
- User-Defined Percentage
- Planning Package
- Resource % Complete.

The Files Tab

The **Files** tab allows you to display the calendar, resource, and code file assignments for a project:

The screenshot shows the 'Project Properties' dialog box with the 'Files' tab selected. The 'Project Name' is 'CLEAN' and the 'Description' is 'Environmental Cleanup Project'. Under 'Calendar File', the value is 'CLEANCAL'. Under 'Resource Definition File', the value is 'CLEANRES'. Under 'Code Files', there are two entries: 'Code1: OBS (CLEANOBS - Cleanup OBS)' and 'Code2: WBS (CLEANWBS - Cleanup WBS)'. The dialog has 'OK', 'Cancel', and 'Help' buttons at the bottom right.

You can also use this tab to assign resource, calendar, and code files to the project.



For more information on assigning auxiliary files to a project, refer to the “Assigning Auxiliary Files to a Project” section of Chapter 3, “Getting Started.” You may also refer to the “New File Wizard — Files Page” section of Chapter 4, “Creating a New File.”

The Status Tab

The **Status** tab displays information about project status:

The screenshot shows the 'Project Properties' dialog box with the 'Status' tab selected. The 'Project Name' is 'CLEAN' and the 'Description' is 'Environmental Cleanup Project'. The 'Status' is set to 'Planned'. Under 'Project Dates', 'Project Start' is '01Jan03 00:00', 'Time Now' is '01Jan03', and 'Scheduled Finish' is '15Mar05'. Other fields like 'Min. Total Float', 'Early Finish', 'Late Finish', 'Target Start', and 'Target Finish' are empty. The 'Finish Type' is set to 'None'. Buttons for 'OK', 'Cancel', and 'Help' are at the bottom right.

You can use this tab to display the following information calculated by Open Plan:

- **Status** — The project status: **Planned**, **In-Progress**, or **Complete**.
- **Min. Total Float** — The total float for the critical path in the project.
- **Early Finish** — The project early finish date as calculated by time analysis.
- **Late Finish** — The project late finish date as calculated by time analysis.
- **Scheduled Finish** — The project scheduled finish date as calculated by resource scheduling.

You can also use this tab to enter the following information about the project:

- **Project Start** — The planned project start date. This date is used for reporting purposes such as the default start date for barcharts.
- **Time Now** — The current project status date. Open Plan will not calculate any activity dates in either time analysis or resource scheduling prior to Time Now. If the project is not yet underway, enter the planned project start date for Time Now. If the project has started and you have entered progress information for one or more activities, Time Now should be the latest date for which all progress information is correct.
- **Target Start** — The target start date is an optional date used by Open Plan in cases where a project appears as an external subproject within a master project.
- **Target Finish** — The target finish date is an optional date used by the time analysis and resource scheduling functions.
- **Finish Type** — You can specify how Open Plan interprets this date with the following types:

- None
- Not Earlier Than
- Not Later Than
- On Target

In general, you should not enter a target finish date for any project before you run time analysis. However, many projects do have target finish dates imposed by outside circumstances. If you must enter a target finish date for the project, the following points describe how a target finish may affect calculations for the rest of the project.

- If you assign a **Not Later Than** target finish date later than or equal to the latest early finish date calculated by time analysis, the target date has no effect. If you enter a project target finish date that is earlier than the early finish date calculated by time analysis, the result is a number of activities with negative total float. This indicates that the target date is not achievable for the project as planned and that replanning may be needed. (Note that the late start date of the first activity in a project indicates the latest date the project can start and remain achievable.)



To determine the latest date a project can start and still finish by a fixed deadline, set a not-later-than finish date for the project and perform time analysis. The late start date for the first activity in the project represents the latest date the project can start and still meet the desired finish date.

- If you assign a **Not Earlier Than** target finish date earlier than or equal to the latest early finish date calculated by time analysis, the target date will have no effect. If you enter a project target date that is later than the early finish date that time analysis would have calculated, the result is additional float for the project.
- If you assign an **On Target** finish date earlier than the calculated early finish date, you create negative float in the project. If you enter a target finish date later than the calculated early finish date, you add float. If you enter a target finish date exactly equal to the calculated date, the target date has no effect.

The Cost Tab

The **Cost** tab displays summary cost information for the project:

Project Properties

Summary Preferences Files Status **Cost** Notes Scheduling User Fields Access Control Open Status References Codes

Project Name: CLEAN Description: Environmental Cleanup Project

Target Total Cost: Reporting Calendar: FISCAL

Use Version 2 Cost Calculation Method

	BAC	BCWS	BCWP	ACWP	EAC
Labor Quantity	7858.00	0.00	0.00	0.00	7858.00
Labor Cost	440321.00	0.00	0.00	0.00	440321.00
Material Cost	148800.00	0.00	0.00	0.00	148800.00
ODC	0.00	0.00	0.00	0.00	0.00
Subcontract Cost	0.00	0.00	0.00	0.00	0.00
Total Cost	589121.00	0.00	0.00	0.00	589121.00

OK Cancel Help

You can use this dialog box to define the following:

- **Target Total Cost** — The value you enter in this field is not used in any cost calculations. However, by entering a target cost in this field, you have a value that you can use as a benchmark when comparing the budget and actual costs of a project with what was originally planned.
- **Reporting Calendar** — This field allows you to specify a reporting calendar file that will be used as a default for date scales that use reporting calendars. When creating or updating a baseline or any resource usage table, Open Plan uses the data in this file to break any usage records that span more than one calendar period into additional records. This feature facilitates the accurate export of time-phased resource assignment information.

The reporting calendar is also useful if your company uses a fiscal calendar that contains periods that do not end on the last day of the month.



While the **Reporting Calendar** feature may be used with any Open Plan project, it is particularly useful to Cobra users as it improves the ability of Cobra to accurately spread time-phased assignment data.

- **Use Version 2 Cost Calculation Method** — This option controls the cost calculations method that Open Plan should use when calculating Budget at Complete (BAC) values at the activity level:
 - When this option is cleared, Open Plan uses the Open Plan Version 3 method. With this method, Open Plan calculates costs based on assignments in the Performance Measurement Baseline (PMB) in the Baseline Usage (BSU) table. If there is no baseline named PMB, Open Plan uses the first selected baseline. This is the default setting for new projects.
 - When this option is selected, Open Plan uses the Open Plan Version 2 method. With this method, Open Plan calculates costs based on the current resource assignments. This is the default setting for projects that were originally created in Open Plan 2.x.

The lower half of this tab is a grid that displays budgeted costs, scheduled value, earned value, actual costs, and remaining costs rolled up to the project level for the following:

- **BAC** — Budget at Completion
- **BCWS** — Budgeted Cost of Work Scheduled

- **BCWP** — Budgeted Cost of Work Performed. This is also referred to as earned value.
- **ACWP** — Actual Cost of Work Performed
- **EAC** — Estimate at Complete



For more information of the costs displayed in the grid, refer to the online Help system for the **Project Properties Cost** tab.

The Notes Tab

The **Notes** tab allows you to attach text information to the project:

You can use the following fields to attach a note to the file:

- **Note** — This text box can contain up to 29 KB of text. You can enter the text by typing directly in this field or by using the Windows **Cut (Ctrl+X)**, **Copy (Ctrl+C)**, and **Paste (Ctrl+V)** commands to insert text from another Windows application such as a word processor or spreadsheet.
- **Category** — This field controls the category of the note. You can select a category from the list of global categories.

Clicking the **abc** button checks the spelling of the text you enter.

You can enter links to files, Web pages, and e-mail addresses by entering the information in one of the following formats:

- File links must be entered in the format of: [file://c:\document.doc](#)



If the file link you enter contains spaces, you must enclose the link with angle brackets (< >) in order for the link to work properly: **<file://C:\Documents and Settings\All Users\Desktop\test.txt>**

- Universal Resource Locators (URLs) must be entered in the format of: [http://deltek.com](#)
- E-mail addresses must be entered in the format of: [mailto:sales@deltek.com](#)



While you can use drag and drop functionality to create links in the **Note** field, the Windows **Cut (Ctrl+X)**, **Copy (Ctrl+C)**, and **Paste (Ctrl+V)** commands are not available for links.

The Scheduling Tab

The summary resource usage file allows different projects to be scheduled successively using only a single resource file. In order to realize the functionality of summary resource usage, it is necessary to define a unique priority for each project.

The **Scheduling** tab allows you to specify both the project's priority and the type of dates that should be used when calculating the resource usage summary.

This tab features the following controls:

- **Project Priority** — Open Plan allows you to specify a priority on the current project. When assigning resources to another project, Open Plan considers only projects with a higher priority than the current project. A higher priority is indicated by a lower numeric value.

When performing resource scheduling on a number of projects at one time (for example, when scheduling external subprojects), Open Plan uses the priority of the master project when determining the availability of resources that are shared with other projects. You can also use the value in the **Project Priority** field as a tiebreaker between external subprojects.



When using the summary usage file from one project in a subsequent project, it is presumed that the next project schedule has a lower priority than the one before (indicated by having a higher project priority number). If the priority of the second project is set higher than the original project, the first project should be scheduled again or you will get unsatisfactory results.

- **Create Summary Usage Upon Saving Project** — In order to take advantage of summary resource usage, the resources used by a project must be saved in summary form with the resource file. If you select this option, Open Plan allows you to select the type of dates (**Early Dates**, **Late Dates**, or **Scheduled Dates**) that it should use when creating a record in the Project Summary Usage (PSU) table. This option makes the data available to other projects

using the same resource file, and the summary resource usage is saved each time the project is saved.

In order for the summary usage to be saved, the following conditions must be met:

- The project must be open in **Exclusive** mode.
- The resource file must be open in **Exclusive** or **Shared** mode. (If the resource file is open in **Read Only** mode, Open Plan offers to save the information in a new resource file.)



The summary resource usage file is not saved when you perform a **Save As** or do a backup. Also, when you do perform a **Save As** or a backup, the option to **Create Summary Usage Upon Saving Project** (as shown above) is automatically cleared on the new project.

- **Create Summary Usage Based On** — This option is enabled when you select the **Create Summary Usage Upon Saving Project** option. This field contains a list of dates that Open Plan should use when creating the summary usage record:
 - Early Dates
 - Late Dates
 - Scheduled Dates
- **Delete Summary Usage For This Project** — Summary resource usage data needs to be deleted when it is no longer appropriate. The data is deleted automatically when a project is associated with a new resource file but not when a project is deleted altogether. When you click the **Delete Now** button, Open Plan deletes the project summary usage data from the PSU table for not only the open project but also for any open external subprojects. This has the effect of freeing the resources so that they can be made available to other projects.

You can also use the **Manage Summary File** dialog box to delete summary usage from a project:

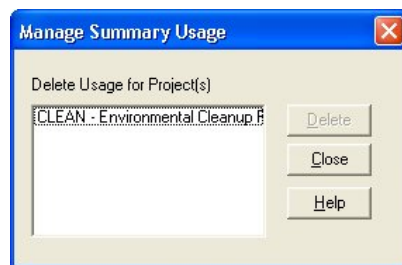

To display the Manage Summary Usage dialog box

1. Display the resource view for the selected project.
2. On the **Tools** menu, click **Manage Summary Usage**.

 You can use either the **Delete Now** button on the **Scheduling** tab of the **Project Properties** dialog box or the **Manage Summary Usage** dialog box to delete summary resource usage on a single project. The **Manage Summary Usage** dialog box, however, can be used to delete summary resource usage on multiple projects that share the same resource file.

The User Fields Tab

The **User Fields** tab allows you to specify the values that Open Plan should include for user-defined fields on the project table.

 User-defined fields are created on the project table outside of an open project and may be used by any project stored in the database. In order to use a user-defined field in your project, you must specify a value for it on this tab.

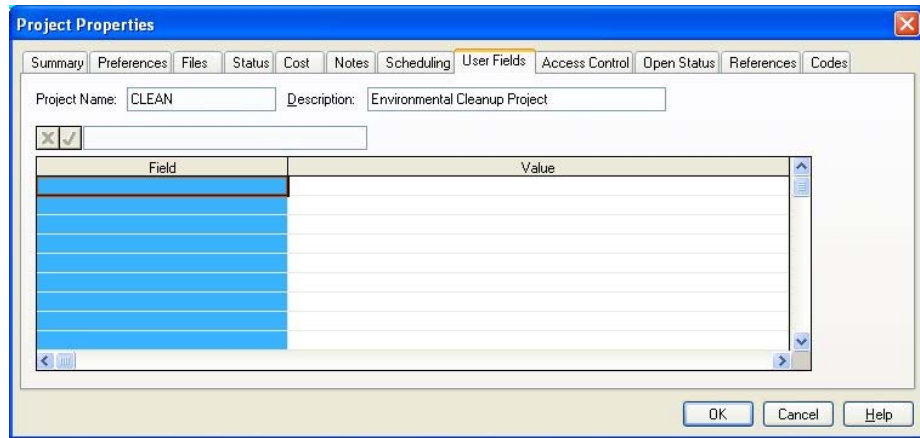

This tab features a grid containing two columns:

- **Field** — This column displays a list of all the user-defined fields that have been defined for the project table.
- **Value** — For each user-defined field that you want to use in your project, you should enter an appropriate value.

For example, if the **Field** is Proj_Sec, you might enter the name of the project secretary as the **Value** for the field.

 For information on creating user-defined fields, refer to Chapter 24, “System Utilities.”

The Access Control Tab

The **Access Control** tab allows you to define the access rights that users or groups have and what role they plan on the project.

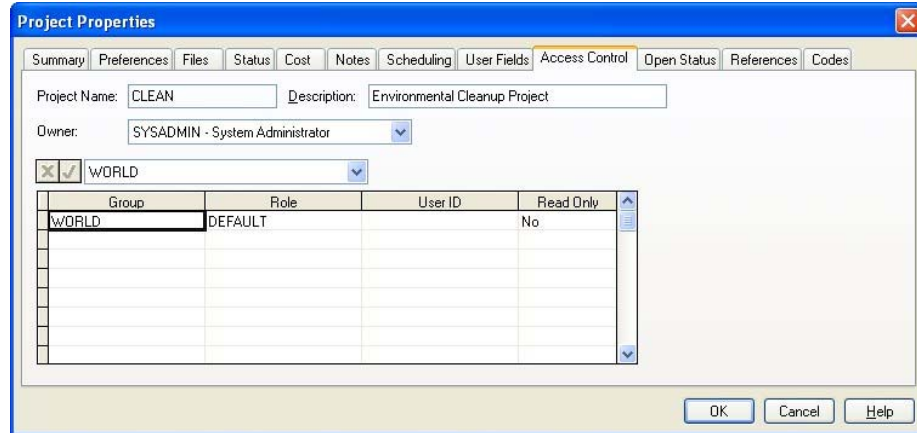

If you are the owner of the project or a member of the System Administrator group and you have the project open in **Exclusive** mode, you can use the following fields to define access rights to the project:

- **Owner** — You can change the owner of the project by selecting a new owner from the list.



If you provide access rights to a group for a project, members of that group automatically inherit read rights to all resource files, calendar files, code files, and external subprojects assigned to that project. Note, however, that it is possible that after you change the ownership of a project to another user, you may not have rights to save the project. If this occurs, simply close the project without saving.

- **Group** — By selecting a field in this column and selecting a group from the list, you can specify the group(s) that can have access to the project.
- **Role** — When you select a group or user ID, its default role is automatically entered in this field. You can then change default role to any role that has been defined in the data source.
- **User ID** — By selecting a field in this column and selecting a user ID from the list, you can specify the users that can have access to the project.
- **Read Only** — By selecting **Yes** for this field, you limit the group or user to opening the project in **Read Only** mode. By selecting **No** for this field, Other users may open the file in any mode they choose. **Read Only** mode has the following limitations:
 - In order to make changes to the project, you must first save the project under a different name.
 - You cannot see changes made by other users.



In order to see changes made by other users who may have the project open in **Exclusive** or **Shared** mode, you have to close and reopen the project.

The Open Status Tab

The **Open Status** tab displays the information about the open status of the project:

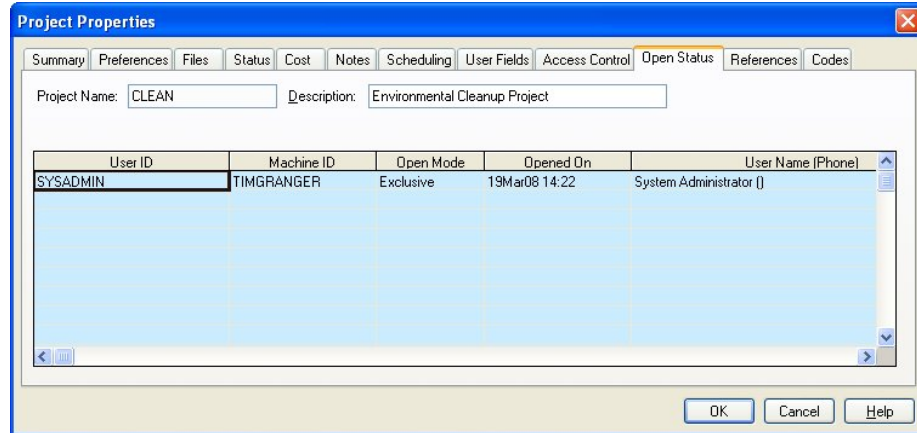

The following information is displayed on this tab:

- **User ID** — This column displays the user ID of each person who has the project open.
- **Machine ID** — This column displays the ID of each computer where the file is open.
- **Open Mode** — This column displays the mode in which the project is open. This mode can be any of the following:
 - **Exclusive** — If a project is open in **Exclusive** mode, you have the exclusive right to make changes to it. While you have the project open in exclusive mode, other users can open the project only in **Read Only** mode.
 - **Shared** — If the project is open in **Shared** mode, other users can open the file and make changes while you have it open.
 - **Read Only** — If the project is open in **Read Only** mode, you cannot use the **Save** command to save any changes you may make. Instead, you must use the **Save As** command and save the project with a different name.



For more information on the three access modes, refer to Chapter 24, "System Utilities."

- **Opened On** — This column displays the date and time that the project was opened by a user.

The References Tab

The **References** tab displays master projects that include this project as an external subproject.

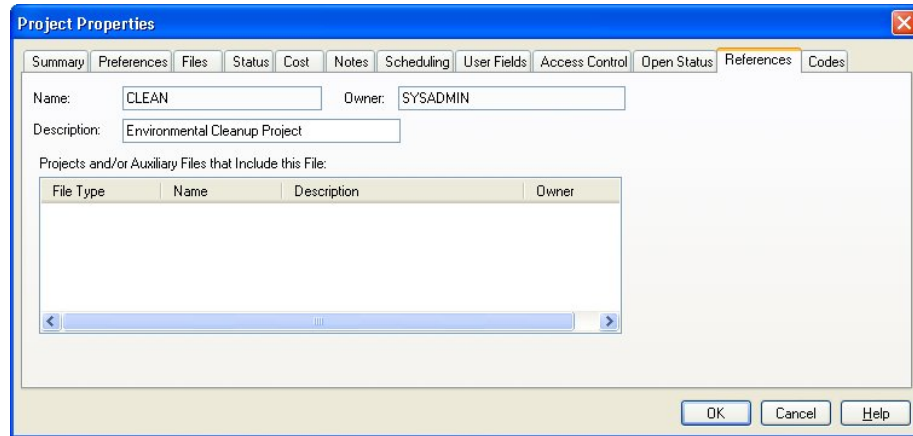

The **References** tab displays object references. This helps you identify dependencies that can be of use when deciding whether to keep or delete data.

The **References** tab contains the following fields:

- **File Type** — The file type is always a project.
- **Name** — The name of the master project that references this project.
- **Description** — The description of the project.
- **Owner** — The owner of the project.

The Codes Tab

The **Codes** tab allows you to assign codes to the project:

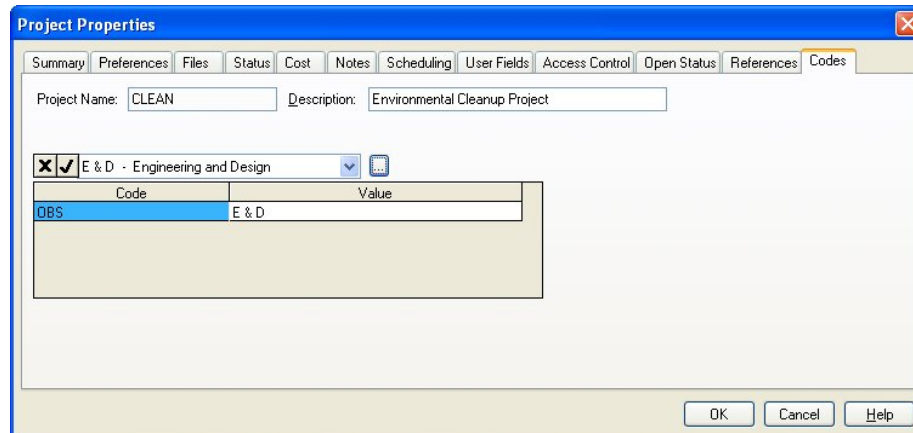

Being able to assign codes to a project allows you to sort your projects. For example, you might want to sort your projects according to a region or division code.

The **Codes** tab contains the following fields:

- **Code** — This column displays all the project-level code files that have been defined.
- **Value** — For each available code file, you can assign a specific code to the project. Clicking the **ellipsis** at the right edge of the input field displays the **Select Code** dialog box that you can use to select a code from a hierarchical code structure.



For more information on project codes, refer to Chapter 11, "Project Codes."

6

Activity Information

➤ Overview	135
➤ Guidelines for Planning Activities.....	136
➤ The Activity Details Dialog Box	137
➤ Entering Activity Relationships.....	143
➤ Using Barchart Views.....	146
➤ Using Network Views	153
➤ Using Spreadsheet Views.....	155
➤ Utilities.....	158

Overview

An activity is the smallest self-contained unit of work used to define the logic of a project. Think of activities as the building blocks of a project. Their definition, therefore, constitutes one of the most important aspects of project planning.

This chapter begins with a general discussion of some guidelines for planning activities followed by a description of the types of information you can enter in Open Plan for activities and relationships. Other topics include the procedures for entering activity and relationship information, both within Open Plan as a whole and within each of the views that allow data entry:

- Barchart views
- Network views
- Spreadsheet views

The chapter concludes with discussions of a number of utilities related to activity information.

Guidelines for Planning Activities

Since projects can vary considerably, there are few hard-and-fast rules about the contents of activities or how long they can last. Activities in a plant maintenance turnaround, for example, might last less than an hour; activities in a long-range development project might have durations of many months or even years.

In general, most activities will share the following characteristics:

- They have a finite duration.
- It is possible to estimate the progress of activities that have started but are not yet finished.
- There is a single point of accountability for accomplishing the activity.

It is a good idea to keep these characteristics in mind when defining activities. By breaking a project down into a set of discrete tasks with relatively limited durations, it is possible to establish more objective, and thus more accurate, estimates of progress.

Many times an activity will have a defined cost associated with it and one or more resource assignments. In the strictest sense, however, these assignments are not necessary. In fact, it is possible to define your activities first and then return at a later date and enter resource information.

It is possible to define an activity as an internal subproject in both the Desktop and the Professional editions of Open Plan. If you are using the Professional edition of Open Plan, you can also define an activity as an external subproject. Both types of subprojects allow you to use a relatively low level of detail when breaking down the work of a project but roll up schedules and costs to high-level summaries for reporting purposes. In Open Plan, an activity representing a subproject is identical to a standard activity except for the fact that the duration and the progress status of the subproject activity is based on its child activities and is recalculated each time you perform time analysis.



For a complete description of internal and external subprojects in Open Plan, refer to Chapter 12, "Hierarchical Projects."

When entering activities for a project, you may want to give some thought to how you want to number your activities. Although you can use other forms of activity information (such as codes) to identify activities, activity IDs are the only identifier that Open Plan validates as being unique for each activity. As a result, the activity ID serves as the default sort order for most views and reports.

Although Open Plan supports almost any activity numbering system, most organizations use activity IDs that have some significance built in. One of the most common approaches is to use the activity ID to associate activities with specific elements in a work breakdown structure (WBS). This type of approach, however, is not required.

Activity IDs in Open Plan do not imply a sequence, and can be entered in any order. Thus, the activity 0002 can be entered before its successor, activity 0001. However, IDs do imply hierarchical relationships, so that activities 0001.1 and 0001.2 are interpreted as being the children of activity 0001. As a result, the use of the period in an activity ID is restricted to indicating project hierarchies.

The Activity Details Dialog Box

The **Activity Details** dialog box displays the basic information about each activity. Open Plan automatically displays this tabbed dialog box each time you add or edit an activity.

The **Activity Details** dialog box contains tabs for the various types of information associated with the activity. This chapter includes discussions of three of the tabs: the **General** tab, the User Fields tab, and the **Relationships** tab. The other tabs are discussed in the following chapters:

- **Resources tab** — Chapter 8, “Resource Assignments”
- **Codes tab** — Chapter 11, “Project Codes”
- **Advanced tab** — Chapter 14, “Resource Scheduling”
- **Risk tab** — Chapter 15, “Risk Analysis”
- **Notes tab** — Chapter 17, “Views and Reports”

You can display the **Activity Details** dialog box for an existing activity in the following ways:

- By selecting the activity in an activity view and clicking **Edit Activity** on the **Edit** menu
- By right-clicking the activity in an activity view and clicking **Edit Activity** on the context menu
- By double-clicking the activity bar in a barchart view
- By double-clicking the activity box in a network view

Because you can update multiple activities without having to close the **Activity Details** dialog box each time, Open Plan automatically saves any changes you make to an activity before displaying the next record. Notice that the **OK** and **Cancel** buttons found on many dialog boxes have been replaced here with the following buttons:

- **Close** — Closes the dialog box and returns to the view. If you have not saved the information currently displayed, Open Plan saves the changes before returning to the view.
- **Undo** — Returns the dialog box to its previous state.
- **Apply** — Saves the changes you have made to the current record.



You must update information for an activity before the **Undo** and **Apply** buttons become active.

You can also use the **New** command to create a new activity while the **Activity Details** dialog box is open. This command functions identically to the **Add Activity** command available on the **Edit** menu.

You can customize the action of the **New** command so that it copies the information for the current activity rather than presenting the user with a blank entry screen. You do this by selecting the **Do Not Clear Contents of the Dialog Box When Creating a New Activity** option on the **Edit** tab of the **Options** dialog box.



For more information on using the **Options** dialog box, refer to Chapter 25, "System Defaults."

The General Tab

Open Plan displays the basic information for an activity on the **General** tab of the **Activity Details** dialog box:

You can enter the following information about each activity:

- **ID** — You can use up to 59 characters including spaces for an activity ID. When entering an activity ID, keep in mind that Open Plan does not distinguish between upper and lower case characters in an ID.
- **Description** — You can enter a description of up to 60 characters for an activity.

By default, Open Plan defines the maximum field lengths of 59 characters for activity and resource IDs, and 60 characters for activity descriptions, resource descriptions, code IDs, and code descriptions. It is possible, however, to modify the standard data structure and data dictionary so that any of these field lengths can be as long as 255 characters for new projects.



For information about customizing the Open Plan standard data structure and data dictionary, contact the Deltek technical support staff.

- **Duration** — You can enter an activity duration in minutes, hours, days, weeks, or months using the following abbreviations:
 - T — minutes
 - H — hours
 - D — days
 - W — weeks
 - M — months

For example, to specify an activity duration of eight hours, enter 8H or 8h.

You can avoid having to specify a time unit when entering durations by assigning a default duration unit for a project through the **Preferences** tab on the **Project Properties** dialog box. Settings on this tab also affect how Open Plan determines the number of hours in a duration defined in days, weeks, or months as well as the minimum unit of duration considered by calculations such as time analysis and resource scheduling.



For more information on these settings, refer to Chapter 5, "File Properties."

You can use decimal values for durations (for example, 1.5d), but you cannot mix date formats by entering durations such as 1w2d.



If you enter a duration that is not consistent with fixed target start and finish dates for the activity, Open Plan will use the duration implied by the target dates when performing time analysis and resource scheduling calculations.

- **Calendar** — If you have assigned a calendar file to the project, you can assign a calendar to the activity. If you do not assign a specific calendar to the activity, Open Plan uses the default calendar to calculate dates for the activity. In projects for which no calendar file has been assigned, all activity dates are calculated using a 5-day, 40-hour work week with no holidays.
- **Type** — The activity type defines how the activity is treated during time analysis. The possible activity types are as follows:
 - **ASAP** (As Soon As Possible) — Calculates the early dates of this activity to be as soon as possible. This is the default activity type.
 - **ALAP** (As Late As Possible) — Calculates the early dates of this activity to be as late as possible without delaying the early dates of any succeeding activities.
 - **Start Milestone** — Uses this activity to signify the start of a project phase. If the activity duration is zero, Open Plan replaces the early and late finish dates with the early and late start dates during time analysis.
 - **Finish Milestone** — Uses this activity to signify the finish of a project phase. If the activity duration is zero, Open Plan replaces the early and late start dates with the early and late finish dates during time analysis.



Define zero-duration activities as either start or finish milestones if you want to avoid showing an activity that is scheduled to finish before it starts.

- **Discontinuous** — Allows Open Plan to interpret the specified duration as a minimum rather than fixed duration for the purpose of time analysis. Discontinuous activities are useful when modeling situations where two activities (or two groups of activities) with dissimilar lengths share start-to-start and finish-to-finish relationships.
- **Subproject** — Interprets this activity as representing an internal subproject and allows Open Plan to calculate its duration based on lower level activities.
- **Hammock** — Interprets this activity as a reporting hammock for other activities.

- **Effort Driven** — Allows Open Plan to calculate the activity duration based on resource assignments.
- **External Subproject** — Interprets this activity as representing an external subproject and allows Open Plan to calculate its duration based on lower level activities. Note that you cannot designate an activity as an external subproject in the Desktop edition of Open Plan.



For more information about internal subprojects, hammocks, and external subprojects, refer to Chapter 12, “Hierarchical Projects.” For more information about effort-driven activities, refer to Chapter 8, “Resource Assignments.” For more information about discontinuous activities, refer to Chapter 8, “Time Analysis Calculations,” in the Deltak Open Plan Developer’s Guide.

- **Target Dates** — Target dates act as user-defined constraints on the calculations performed by time analysis and resource scheduling. You can enter start and finish targets and define how the constraint should be interpreted as follows:
 - **Not Earlier Than** — Do not schedule the activity earlier than this target date. This is the default setting for target start dates.
 - **Not Later Than** — Do not schedule the activity later than this target date. This is the default setting for target finish dates.
 - **On Target** — Schedule the activity on the target date.
 - **Fixed Target** — Schedule this activity on the target date, regardless of the project logic. In addition, set the total float of the activity to zero or possibly negative depending on predecessor logic and Time Now. This negates the effect of any prior float in the project upon subsequent activities.



Use target dates sparingly, particularly in the early stages of the planning process. Extensive use of target dates often has the effect of artificially distorting the patterns of float within a project, making analysis of the network more difficult. Instead, allow Open Plan as much flexibility as possible to produce the most efficient set of project dates during your initial calculations. Then you can assign the necessary target dates and see how they affect the network schedule as whole.

- **Sub-Project** — Displays the name of the project represented by the activity in this field when the activity type is **External Subproject**.



In the Professional edition of Open Plan, you can click the **ellipsis** button at the right edge of the **Subproject** edit box and select a project that will become the external subproject.

Using Automatic Numbering

When creating a new activity, you can have Open Plan generate the activity IDs automatically. If you leave the **ID** field blank on the **General** tab of the **Activity Details** dialog box when creating a new activity, Open Plan generates an ID for the new activity according to the following rules:

- If the previous ID at a given level is all alphabetic, the program increments alphabetically.

- If the previous ID at a given level is a mixture of alphabetic and numeric characters, the numeric part is incremented numerically.
- If there is no previous ID, the program uses a numeric ID. Therefore, the first ID in the file is numbered "1."

Open Plan attempts to find a pattern in the activity ID numbering scheme for IDs that are incremented numerically by looking at the last two IDs in the hierarchy. If a pattern can be established, Open Plan uses the pattern when automatically creating a new activity ID.

For example, assume that your project has the following hierarchy:

A11
A12
A13
A14
A15
A20

Open Plan looks at the last two IDs in the hierarchy and determines that there is an difference of 5 between the two. Therefore, if you use automatically numbering to create the next ID, Open Plan creates activity ID A25.

On the other hand, if there is only one activity ID in the hierarchy and you have Open Plan create the other IDs, it uses the ID's value as the incremental pattern.

For example, if you enter 12 for the first ID in the hierarchy and then have Open Plan create the remaining IDs, it increments the IDs by 12 resulting in the following hierarchy:

12
24
36
480
60



For information on using automatic numbering when creating new codes within a code view, refer to Chapter 11, "Project Codes."

The User Fields Tab

When you click the **User Fields** tab on the **Activity Details** dialog box, the following is displayed:

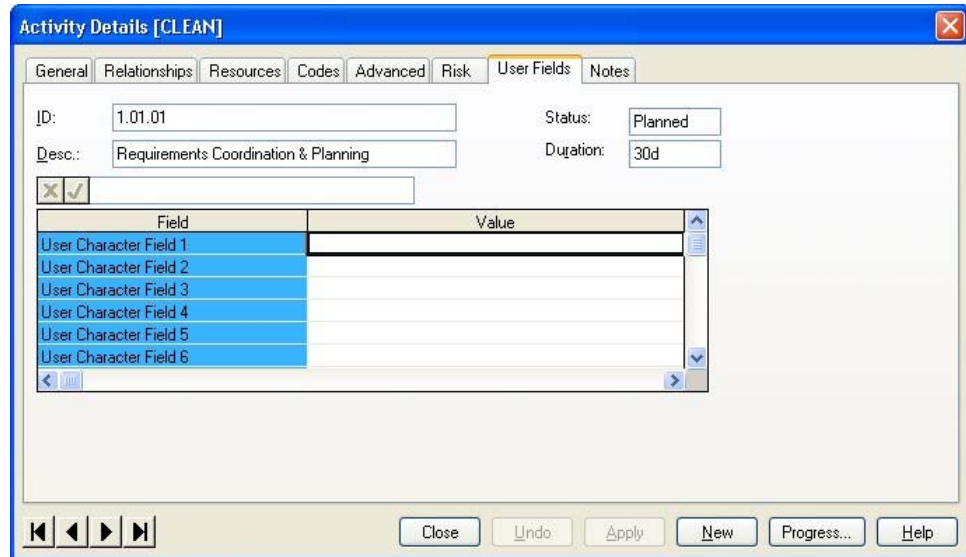

Activity Details [CLEAN]

General Relationships Resources Codes Advanced Risk **User Fields** Notes

ID: 1.01.01 Status: Planned
 Desc.: Requirements Coordination & Planning Duration: 30d

Field	Value
User Character Field 1	
User Character Field 2	
User Character Field 3	
User Character Field 4	
User Character Field 5	
User Character Field 6	

Close Undo Apply New Progress... Help

This tab allows you to specify the values that Open Plan should include for user-defined fields on the activity, using the following fields:

- **Field** — This column displays a list of all the user-defined fields that have been defined.
- **Value** — For each user-defined field that you want to use, you should enter an appropriate value.



User-defined fields are created on the activity table outside of an open project and may be used by any activity stored in the database. In order to use a user-defined field for your activity, you must specify a value for it on this tab.

Entering Activity Relationships

Activity relationships define which activities are logical predecessors and successors of each other. To enter information about the relationships of an activity, you can use either the **Relationships** tab of the **Activity Details** dialog box or the **Add Relationships** dialog box.

The Relationships Tab

To enter relationship information using the **Activity Details** dialog box, click the **Relationships** tab:

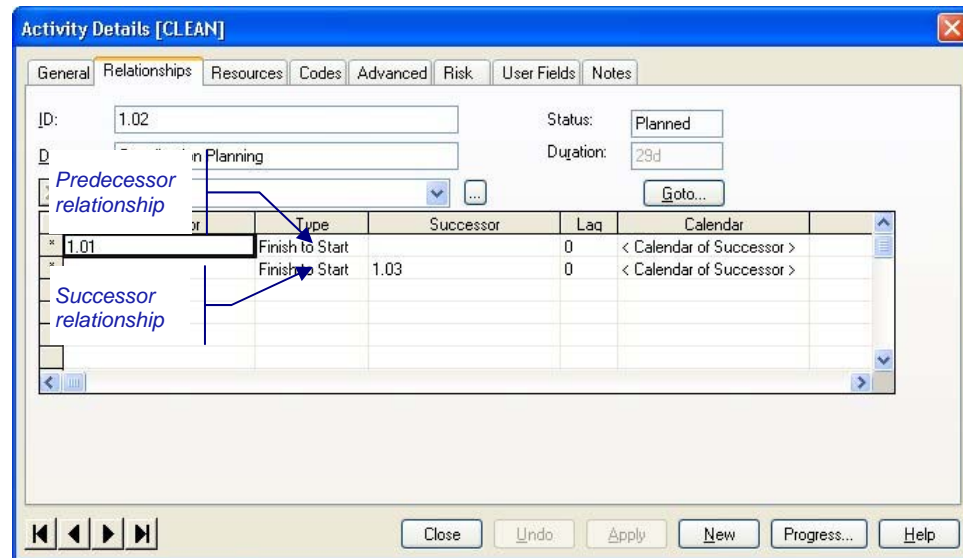

Each relationship with a predecessor or successor activity occupies a separate line in the entry grid. You cannot specify both a predecessor and a successor activity for the same relationship on the same row. To delete a relationship, you must first select the row by clicking the selection button displayed to the left of the row.

Controlling relationships (that is, relationships that determine the early dates of an activity) display an asterisk in the selection button.



If you let the cursor hover over the **Predecessor** and **Successor** ID in the grid, it displays a popup text message indicating the description of the ID followed in parentheses by the status of the ID.

You can use the **Goto** button to display the information for a selected predecessor or successor. To use this feature, select the ID of a predecessor or successor activity and then click **Goto**. Open Plan changes the focus to the specified activity.

This dialog box also shows the total float and free float for each predecessor and successor relationship. To see these fields, use the horizontal scroll bar to display the rightmost fields in the grid or reduce the width of displayed columns by dragging the column boundaries.



For information about relationship float, refer to Chapter 8, "Time Analysis Calculations," in the *Deltek Open Plan Developer's Guide*.

You can enter the following information about each relationship:

- **Predecessor** — If you are defining a relationship with a predecessor activity, enter the ID of the predecessor and leave the **Successor** field on the row blank.
- **Type** — You can define any relationship as one of four types:
 - **Finish to Start** — The successor activity cannot start until the predecessor activity is complete. This is the default relationship type.
 - **Start to Start** — The successor activity cannot start until the predecessor activity has started.
 - **Start to Finish** — The successor activity cannot finish until the predecessor activity has started. This type of relationship is rarely used.
 - **Finish to Finish** — The successor activity cannot finish until the predecessor activity is complete.
- **Successor** — If you are defining a relationship with a successor activity, enter the ID of the successor and leave the **Predecessor** field on the row blank.
- **Lag** — Lag is the time delay associated with the relationship. Lags can be either positive (to indicate a delay between two events) or negative (to indicate an overlap or lead time between two events). For example, if an activity cannot start until two days after the completion of its predecessor, define a finish-to-start relationship between the two activities and enter a lag of 2 days.

For start-to-start relationships, it is also possible to define a lag as a percentage of the predecessor activity's duration. To enter a duration-driven lag, enter a value followed by a percent sign (%). For example, to define a lag equal to one half of the predecessor's duration, enter 50%.



To shorten the overall duration of a project, identify activities that can be overlapped and define their relationships with lag or lead times.

- **Calendar** — By default, the calculation of lag times uses the calendar assigned to the successor activity. You can, however, assign a different calendar to the lag.



A common use of relationship calendars is to schedule lags based on duration-driven rather than activity-driven processes. For example, assume you want to schedule two activities in sequence: pouring a foundation and removing the forms. This is a finish-to-start relationship, but the laborers removing the forms cannot start their work until the concrete cures. The lag that occurs while the concrete cures should be scheduled using a 7-day, 24-hour calendar instead of a calendar based on the laborers' work week.

- **Probability** — In the absence of progress on any successor activities, this column is used to indicate a relative probability that a particular path out of an activity will be taken. Probabilities for various options are mutually exclusive, such that the percent values for multiple options do not have to equal 100%.

If successor activities have been started, it is assumed that the path has been taken already and the probabilities are ignored.

To add a relationship using the Activity Details dialog box

1. Take one of the following actions:

- Select the predecessor or the successor activity for which you want to add a relationship, and click **Edit Activity** on the **Edit** menu.
 - Right-click the activity, and click **Edit Activity** on the context menu.
2. Click the **Relationships** tab.
 3. Enter the information for the relationship, and click **Close**.

The Add Relationship Dialog Box

You can also enter relationships by clicking the **Add Relationship** command on the **Edit** menu. This command displays the following dialog box, which you can use to enter the same types of information that appear on the **Relationships** tab of the **Activity Details** dialog box.

Use this dialog box to define relationships between any two activities in the project.

To add a relationship using the Add Relationship dialog box

1. On the **Edit** menu, click **Add Relationship**.
2. In the **Add Relationship** dialog box, enter the information for the relationship, and click **OK**.

Loop Detection

Whenever you enter a relationship between activities, Open Plan automatically checks that a logical loop has not been defined. To do this, Open Plan considers the relationships between the activities and sorts them in an order to be processed. Open Plan ensures during this process that no activity is processed before any of its logical predecessors.

In the course of the sort, Open Plan may find that entering the relationship would create a logical loop in the project. In effect, this means that at least two activities are mutually dependent. (Neither activity can start before the other.) If a loop is detected, Open Plan immediately deletes the relationship that would otherwise cause the loop and alerts you of this action. If you are entering relationships in a network view, Open Plan also selects all of the activities that comprise the loop.

Because of the speed at which Open Plan performs this function, you may not be aware that it is taking place unless a logical loop is actually detected.

Using Barchart Views

Because it combines a traditional Gantt-style barchart with a spreadsheet, a barchart view provides a convenient way to enter activities and their durations. This type of view is often used as the default start-up view for a project. Barchart views consist of three panes:

- The barchart pane
- The spreadsheet pane
- The histogram pane.

You can use either the barchart pane or the spreadsheet pane for entering activity information.

The Barchart Pane

The barchart pane displays activity information as date-driven bars arranged along a date scale:

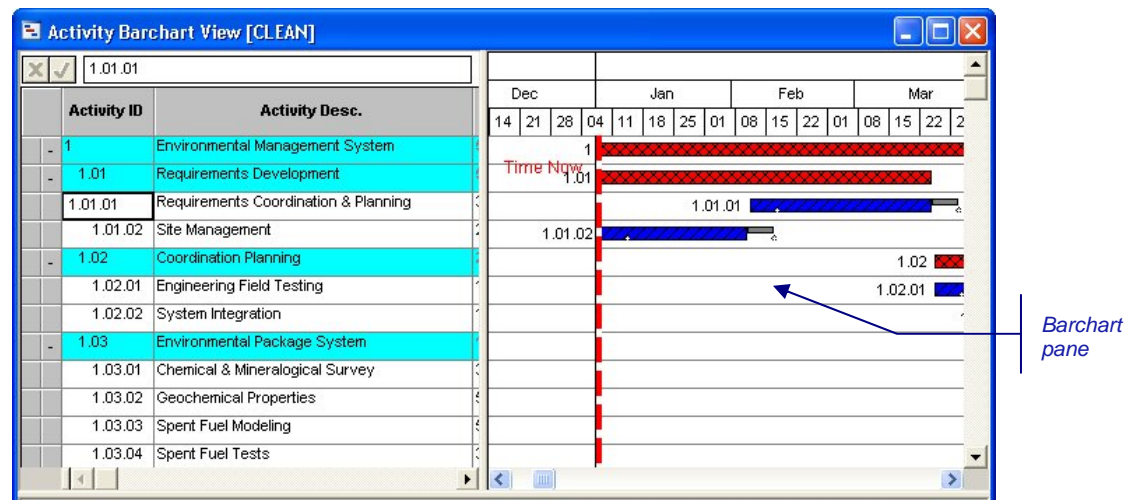

To add an activity in the barchart pane, simply double-click an empty row in the barchart or click **Add Activity** on the **Edit** menu. You can also display relationship information for activities in the barchart pane.

To add an activity in the barchart pane

1. Take one of the following actions:
 - Double-click an empty row in the barchart pane.
 - Double-click the selection button to the left of an empty row in the spreadsheet pane.
 - On the **Edit** menu, click **Add Activity**.

To display relationships in the barchart pane

1. Take one of the following actions:
 - On the **Tools** menu, click **Barchart Preferences**.

- Right-click an empty area within the barchart pane, and click **Preferences** on the context menu.
2. On the **Barchart Preferences** dialog box, click Show Relationships.



For information about the other options for viewing relationships, refer to Chapter 18, “Barchart Views.”

The Bar Data Mode and the Relationship Mode

The barchart pane provides two modes for entering activity-related information:

- The **Bar Data Mode** for entering activity durations and target dates
- The **Relationship Mode** for entering activity relationships.

The **Bar Data Mode** offers a convenient way to enter and schedule groups of activities:

 Bar Data Mode button

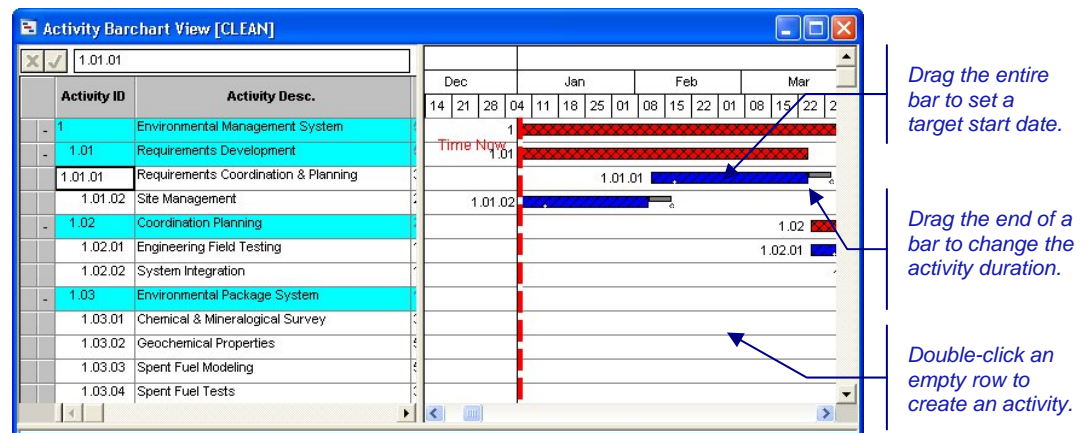

It is possible to change the target start date of an activity by repositioning the bar along the time line or to change the activity duration by stretching or shrinking the bar. If you have automatic time analysis turned on, the length or position of the bar changes immediately. If you do not have automatic time analysis turned on, the bar does not reflect your changes until the next time you perform time analysis.

The granularity of the date scale can also affect the manipulation of bars. For example, if the smallest units displayed on the date scale are months, you may not be able to set the target start of an activity to a specific day.



For information about customizing the date scale in a barchart view, refer to Chapter 18, “Barchart Views.”

For bars to be eligible for manipulation in the bar chart view, the bar type must display early dates and must have the **Drag** option set to **Yes**.



For information about defining custom activity bar types, refer to Chapter 6, “Customizing Barchart Views,” in the *Deltak Open Plan Developer’s Guide*.

 Relationship Mode button

Barchart panes also allow you to display and enter relationships between activities. To use a barchart pane for entering relationship information, click the **Relationship Mode** button on the toolbar:

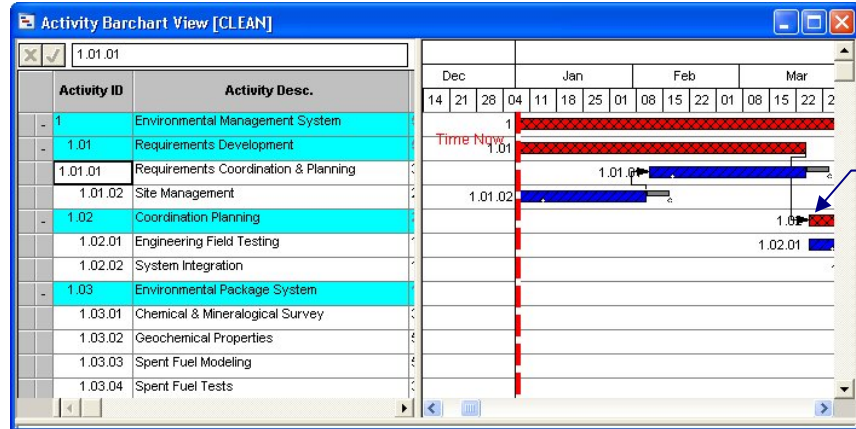

In the **Relationship Mode**, you can use the mouse to draw relationships between activities by linking the start or finish of one bar to the start or finish of another bar. All four types of relationships can be created using this technique:

- **Finish to Start** — The successor activity cannot start until the predecessor activity is complete. This is the default relationship type.
- **Start to Start** — The successor activity cannot start until the predecessor activity has started.
- **Start to Finish** — The successor activity cannot finish until the predecessor activity has started. This type of relationship is rarely used.
- **Finish to Finish** — The successor activity cannot finish until the predecessor activity is complete.

To change the barchart pane to the Bar Data Mode

1. Take one of the following actions:
 - On the **View** menu, click **Bar Data Mode**.
 - On the toolbar, click the **Bar Data Mode** button.

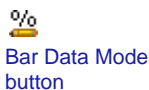

To change an activity target start date in Bar Data Mode

1. Using the mouse, position the cursor in the middle of the activity bar.
2. When the cursor changes to a double-headed arrow, drag the bar to the desired position.



To change an activity duration in Bar Data Mode

1. Using the mouse, position the cursor on the right edge of the activity bar.
2. When the cursor changes to a single-headed arrow, stretch or shrink the bar to the desired length.



For information using a mouse to enter progress information about the activity in a barchart view, refer to Chapter 16, "Status Information."

To change the barchart pane to the Relationship Mode

1. Take one of the following actions:
 - On the **View** menu, click **Relationship Mode**.



- On the toolbar, click the **Relationship Mode** button.



Clicking the **Relationship Mode** button automatically turns on the display of relationships in the view.

To enter a relationship in Relationship Mode

- Take one of the following actions:
 - Drag the cursor from the start or finish of an activity to the start or finish of its successor.
 - On the **Edit** menu, click **Add Relationship**, and enter the predecessor and successor activities.

To edit a relationship in Relationship Mode

- Take one of the following actions:
 - Position the cursor at the beginning or end of a relationship line, and when it changes shape to a crosshair, right-click, and click **Edit Relationship** on the context menu.
 - Double-click the predecessor or successor activity, and click the **Relationships** tab on the **Activity Details** dialog box.

To create an activity by drawing a relationship in Relationship Mode

- Draw a relationship from an existing activity to an empty row in the barchart.

The Spreadsheet Pane

The spreadsheet pane of a barchart view uses a tabular format to display activity information in rows and columns:

Spreadsheet pane

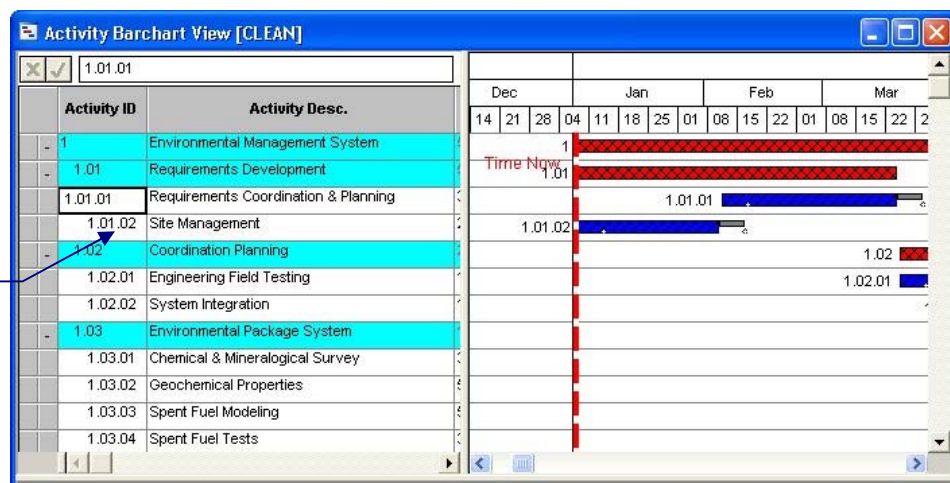

You can enter, display, and edit any activity-related information in the spreadsheet pane of a barchart view, including information stored in user-defined fields.

For fields with a limited number of valid entries (for example, an activity type), Open Plan displays a list of valid choices in the edit box.



For information about changing the arrangement and display of columns in the spreadsheet pane, refer to Chapter 20, “Spreadsheet Views.”

Because data entry in the spreadsheet pane tends to be keyboard-oriented, Open Plan provides a number of keyboard shortcuts for navigating and updating information in this type of display. Three of the most common navigation shortcuts are as follows:

- To move down one cell, press **Enter**.
- To move right one cell, press **Tab**.
- To move left one cell, press **Shift+Tab**.

Other keyboard functions depend on the type of cell that has focus when you press a key. For example, if you have selected a data entry cell (that is, a cell in which you can enter text, numeric, or date information), the following keyboard shortcuts are available:

Key	Action
Down arrow	Move down one cell
Up arrow	Move up one cell
Left arrow	Move left one character
Right arrow	Move right one character
Shift+Left arrow	Select previous character
Shift+Right arrow	Select next character
Ctrl+Up arrow	Move to top row in view
Ctrl+Down arrow	Move to bottom row in view
Ctrl+Left arrow	Move to first cell in row
Ctrl+Right arrow	Move to last displayed cell in row
Page Up	Move up one screen
Page Down	Move down one screen
Home	Move to first character in cell
End	Move to last character in cell
Ctrl+Home	Move to top left cell
Ctrl+End	Move to bottom right cell

If you have selected a cell displaying data generated by Open Plan (for example, an early start date), the following keyboard shortcuts are available:

Key	Action
Down arrow	Move down one cell
Up arrow	Move up one cell
Left arrow	Move left one cell
Right arrow	Move right one cell
Ctrl+Up arrow	Move to top row in view
Ctrl+Down arrow	Move to bottom row in view
Ctrl+Left arrow	Move to first cell in row
Ctrl+Right arrow	Move to last displayed cell in row
Page Up	Move up one screen
Page Down	Move down one screen
Home	Move to first cell in row
End	Move to last cell in row
Ctrl+Home	Move to top left cell
Ctrl+End	Move to bottom right cell

Finally, if you have selected a cell with a fixed number of valid values (for example, activity type), the following keyboard shortcuts are available:

Key	Action
Down or Right arrow	Choose next value
Up or Left arrow	Choose previous value
Home	Choose first value
End	Choose last value

To add an activity

- Take one of the following actions:
 - On an empty row, select the **Activity ID** field, and enter an ID for the new activity.
 - On the **Edit** menu, click **Add Activity**.
 - Double-click an empty row.

To display the Activity Details dialog box for an activity

1. Take one of the following actions:
 - Select the activity, and click **Edit Activity** on the **Edit** menu.
 - Double-click the selection button to the left of the row.
 - Right-click the selection button, and click **Edit Activity** on the context menu.

Using Network Views

Network views are handy for defining the logic of a project since you can rapidly enter activities and their relationships with a mouse.

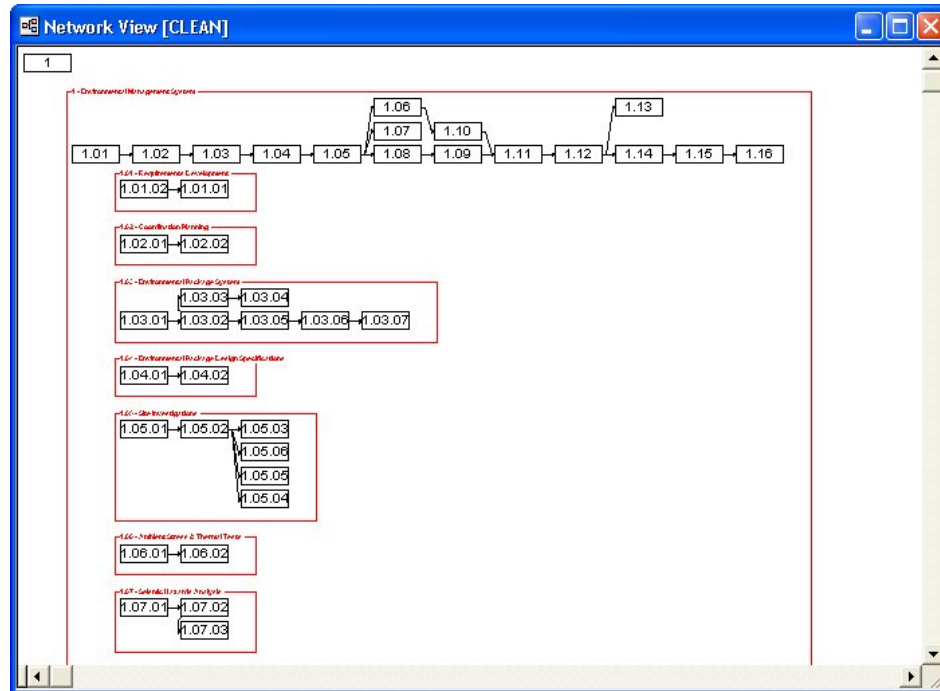

In addition to entering activity information, you can modify the appearance and position of individual activity boxes and relationship lines within a view. You can also click a relationship and then have Open Plan go to and select the predecessor or successor of the relationship automatically.



For information about changing the display of activities or relationship lines in a network view, refer to Chapter 19, "Network Views."

To add an activity in a network view

1. Take one of the following actions:
 - Double-click an empty area in the view.
 - Draw a relationship from an existing activity to an empty area in the view.
 - On the **Edit** menu, click **Add Activity**.

To change the shape of an activity box

1. Position the cursor over the lower right corner of the activity box.
2. When the cursor changes shape to a double-headed arrow, drag the corner of the box to reshape it.



To move an activity box

1. Position the cursor over the center of the activity box.



Move cursor



Add Relationship cursor

2. When the cursor changes shape to a hand, drag the box to the new location.

To add a relationship

1. Take one of the following actions:
 - Drag the cursor from the start or finish of an activity to the start or finish of its successor.
 - On the **Edit** menu, click **Add Relationship** , and enter the predecessor and successor activities.

To edit a relationship

1. Take one of the following actions:
 - Double-click the relationship line.
 - Right-click the relationship line, and click **Edit Relationship** on the context menu.
 - Select the predecessor or successor activity, click **Edit Activity** on the **Edit** menu, and display the **Relationships** tab.
 - Right-click the predecessor or successor activity, and click the **Relationships** tab on the **Edit** menu.

To delete a relationship

1. Take one of the following actions:
 - Right-click the relationship line, and click **Delete Relationship** on the context menu.
 - Position the cursor over the arrow head of the relationship line. When the cursor changes shape, drag the line back to the predecessor activity.

To change the shape of a relationship line

1. Position the cursor over the relationship line.
2. When the cursor changes to a crosshairs, drag the line to change its shape.

To straighten a relationship line

1. Right-click the relationship line, and click **Make Straight** on the context menu.

To go to the predecessor of a relationship

1. Right-click the relationship line, and click **Go to Predecessor** on the context menu.

To go to the successor of a relationship

1. Right-click the relationship line, and click **Go to Successor** on the context menu.



Update Relationship cursor

Using Spreadsheet Views

You can enter both activity and relationship information using standard Open Plan spreadsheet views. Spreadsheet views are particularly useful in cases where you want to display information for many activities at the same time.

Click to select activity or double-click to display the Activity Details dialog box.

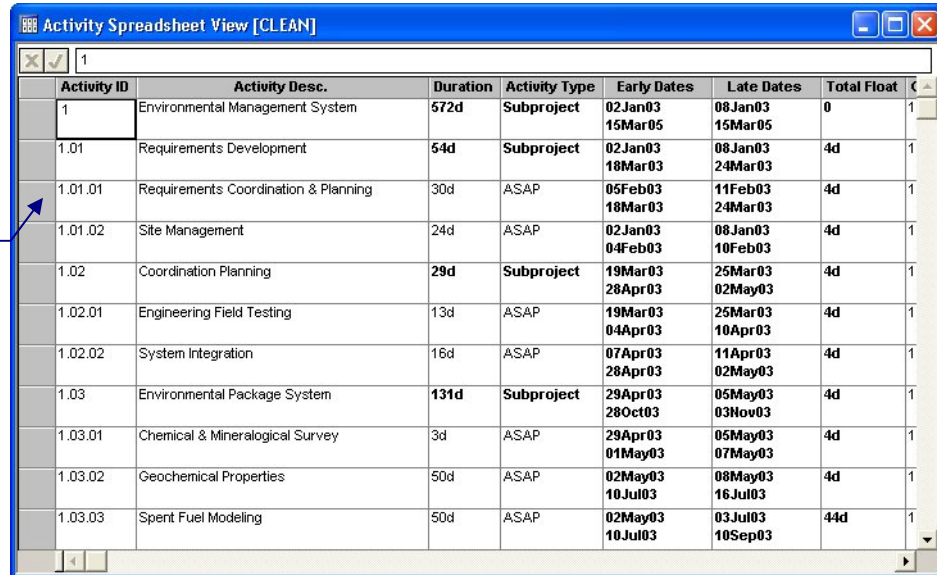

Activity ID	Activity Desc.	Duration	Activity Type	Early Dates	Late Dates	Total Float
1	Environmental Management System	572d	Subproject	02Jan03 15Mar05	08Jan03 15Mar05	0
1.01	Requirements Development	54d	Subproject	02Jan03 18Mar03	08Jan03 24Mar03	4d
1.01.01	Requirements Coordination & Planning	30d	ASAP	05Feb03 18Mar03	11Feb03 24Mar03	4d
1.01.02	Site Management	24d	ASAP	02Jan03 04Feb03	08Jan03 10Feb03	4d
1.02	Coordination Planning	29d	Subproject	19Mar03 28Apr03	25Mar03 02May03	4d
1.02.01	Engineering Field Testing	13d	ASAP	19Mar03 04Apr03	25Mar03 10Apr03	4d
1.02.02	System Integration	16d	ASAP	07Apr03 28Apr03	11Apr03 02May03	4d
1.03	Environmental Package System	131d	Subproject	29Apr03 28Oct03	05May03 03Nov03	4d
1.03.01	Chemical & Mineralogical Survey	3d	ASAP	29Apr03 01May03	05May03 07May03	4d
1.03.02	Geochemical Properties	50d	ASAP	02May03 10Jul03	08May03 16Jul03	4d
1.03.03	Spent Fuel Modeling	50d	ASAP	02May03 10Jul03	03Jul03 10Sep03	44d

You can enter, display, and edit any activity-related information in an activity spreadsheet view, including information stored in user-defined fields.



For a description on how to enter this type of information, refer to the discussion of the spreadsheet pane in the "Using Barchart Views" section earlier in this chapter.

For displaying relationship information, Open Plan supplies two types of spreadsheet views: relationship spreadsheets and predecessor/successor spreadsheets.

Relationship spreadsheet views resemble activity spreadsheet views but display information about each activity relationship on a single row:

Click to select a relationship.

Predecessor/successor spreadsheets display multiple relationships for each activity using an outlining format.

Click to expand or collapse an activity.

In a predecessor/successor spreadsheet view, Open Plan displays a **plus sign (+)** or a **minus sign (-)** on the outlining button to the left of the row to control the display of relationship information. If the outlining button displays a plus sign, you can expand the activity to see its relationships. If the outlining button displays a minus sign, the activity is already expanded — clicking the outlining button will collapse the display of relationships. If the outlining button is blank, the activity does not have any relationships.



For information about expanding and collapsing items in a spreadsheet view, refer to Chapter 12, “Hierarchical Projects.”

Although you can use either a relationship spreadsheet or a predecessor/successor spreadsheet view to display information about activity relationships, Open Plan does not allow you to change relationship information in a predecessor/successor spreadsheet. You must use a relationship spreadsheet to

add or update relationship information. The same keyboard shortcuts available in activity spreadsheets are available in relationship spreadsheets as well.

To add a relationship using a dialog box

1. On the **Edit** menu, click **Add Relationship**.
2. Enter the information for the relationship.
3. To return to the view, click **OK**.

To add a relationship in a relationship spreadsheet

1. On a blank row, select the **Predecessor** cell.
2. Click the **ellipsis** button to the right of the edit box at the top of the spreadsheet.

Open Plan displays the **Choose a Value** dialog box listing the available activities.

3. Select the predecessor activity from the list, and click **OK**.
4. Select the **Successor** cell for the row, and repeat steps 2 and 3.
5. Enter the rest of the information for the relationship.

Utilities

Open Plan provides a number of utilities related to displaying activity information, including:

- Finding activities
- Displaying activity information
- Displaying a particular project date
- Deleting an activity
- Setting column/row attributes for a view

The first two utilities are available in barchart, network, and activity spreadsheet views. The third utility is available in either the barchart or the histogram view. The fourth applies to any activity.

Finding an Activity

You can use the **Find** command to locate and display the information about an activity in a view:

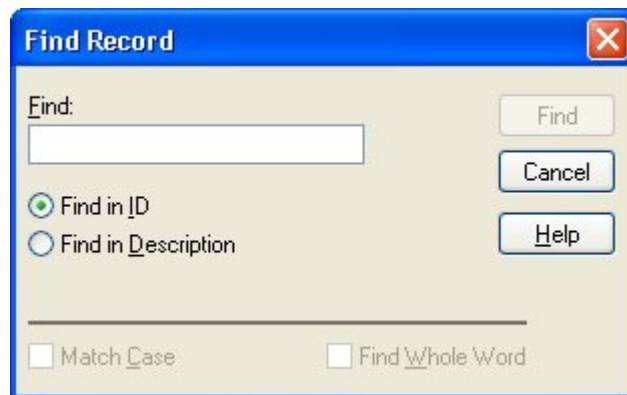

You can define the object of your search as either an activity ID or text contained within an activity description. If you search on text appearing in the activity description, you can limit the search operation with the following options:

- **Match Case** — Limit the search to description text that matches the use of upper- and lower-case letters in the find text.
- **Find Whole Word** — Find only description text that includes an exact match of the target text. For example, use this option if you do not want Open Plan to find descriptions containing the word “information” based on a search for the word “form.”

If you search on activity descriptions, you can repeat the operation with the **Find Next** command.

If you are searching for an activity that is not currently displayed because it resides at a different hierarchical level, Open Plan responds as follows:

- In a network view, Open Plan goes to the appropriate subproject level.
- In barchart and spreadsheet views, Open Plan expands the appropriate parent activities.

If you are searching for an activity that is not currently displayed because of a view filter, Open Plan displays a message explaining that it cannot display the activity at this time.

You can also use the **Find** command to locate any type of data in a spreadsheet column (for example, a date). If you use the **Find** command with a column selected, the **Find in ID** and **Find in Description** options are unavailable.



To locate any type of data in a spreadsheet column, select the column and click **Find** on the **Edit** menu or right-click the column heading and click **Find** on the context menu.

To find an activity

1. Take one of the following actions:
 - On the **Edit** menu, click **Find**.
 - Press **Ctrl+F**.
 - Right-click an empty area of the view and, click **Find** on the context menu.
2. Enter either the activity ID or the text appearing in the activity description, and click **Find**.

To repeat the find operation

1. Take one of the following actions:
 - On the **Edit** menu, click **Find Next**.
 - Press **F3**.
 - Right-click an empty area of the view, and click **Find Next** on the context menu.

To find data in a spreadsheet column

1. Take one of the following actions:
 - Select the column, and click **Find** on the **Edit** menu.
 - Select the column, and press **Ctrl+F**.
 - Right-click the column heading, and click **Find** on the context menu.
2. Enter the information for the operation, and click **Find**.

Displaying Activity Information

Use the **Activity Information** command to display a wide range of information for a single activity. To display information related to the activity schedule, use the **Schedule** tab of the **Activity Information** dialog box:

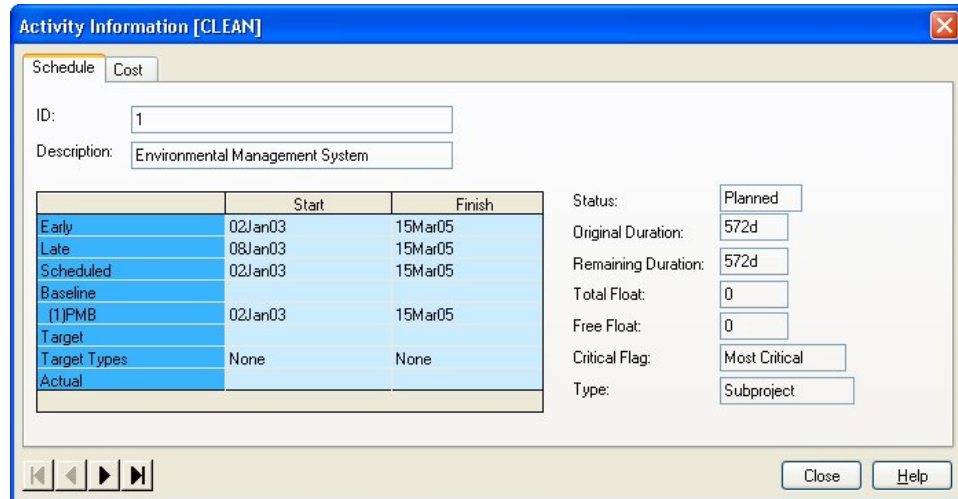

Schedule-related information displayed for each activity includes:

- The early and late dates calculated by time analysis
- The scheduled dates calculated by resource scheduling
- Any baseline(s) assigned to the project.
- Any target dates assigned to the activity
- Values for total float, free float, and an indication if the activity is one of the following:
 - **Not Critical** — an activity whose total float is greater than zero
 - **Critical** — an activity whose total float is zero or less
 - **Most Critical** — an activity possessing the least amount of total float in the project
 - **Controlling Critical** — an activity that is potentially critical but has float due to calendars

To display information related to the activity costs, use the **Cost** tab of the **Activity Information** dialog box:

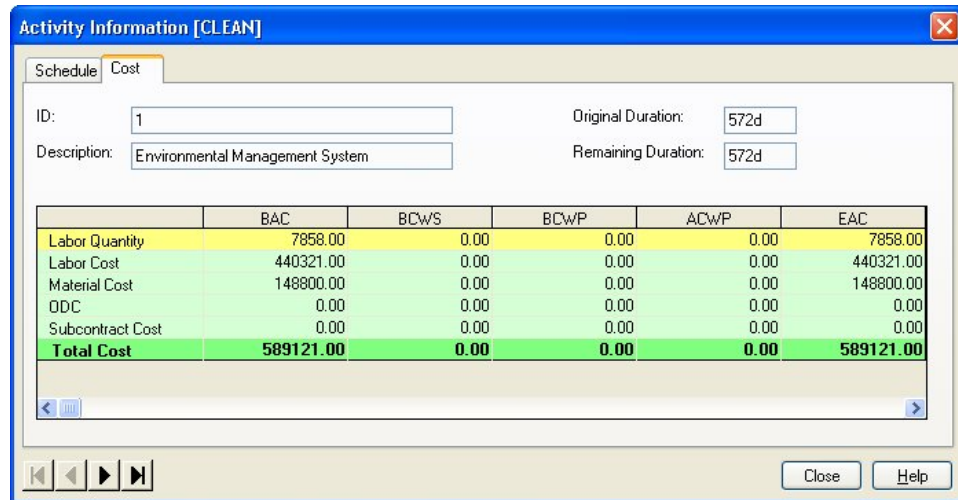

This tab displays budgeted and actual costs calculated at the activity level for the following:

- **BAC** — Budget at Completion
- **BCWS** — Budgeted Cost of Work Scheduled
- **BCWP** — Budgeted Cost of Work Performed. This is also referred to as Earned Value.
- **ACWP** — Actual Cost of Work Performed
- **EAC** — Estimate at Complete



For more information of the costs displayed in the grid, refer to the online Help system for the **Activity Information Cost** tab. For more information about entering cost information, refer to Chapter 10, "Cost Information."

You can display this dialog box in any barchart, network, or spreadsheet view. Note that this dialog box, like the **Activity Details** dialog box, is modeless; you can leave it open when performing other operations. You can also use the navigation controls displayed in the lower left corner of the dialog box to scroll through the activities in a network.

To display activity information

1. Take one of the following actions:
 - Select the activity, and click **Activity Information** on the **Edit** menu.
 - Right-click the activity, and click **Activity Information** on the context menu.
 - Select the activity, and press **F5**.

Finding a Date

To display a date in a time-scaled view such as a barchart or histogram, use the **Go To Date** command to display the **Go to Date** dialog box:

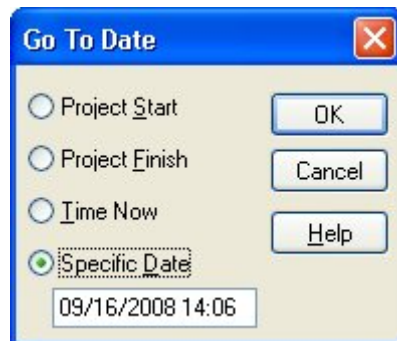

With this dialog box, you can have Open Plan automatically display the portion of the view that contains one of the following dates:

- The project start date
- The project finish date
- Time Now

- A specific date

To find a date

1. Take one of the following actions:
 - On the **View** menu, click **Go To Date**.
 - Right-click an empty area of the barchart, and click **Go To Date** on the context menu.
2. Select the date you want to display in the view, and click **OK**.

Deleting an Activity

When you click **Delete** on the **Edit** menu with an activity view open, the **Delete Activity** dialog box displays:

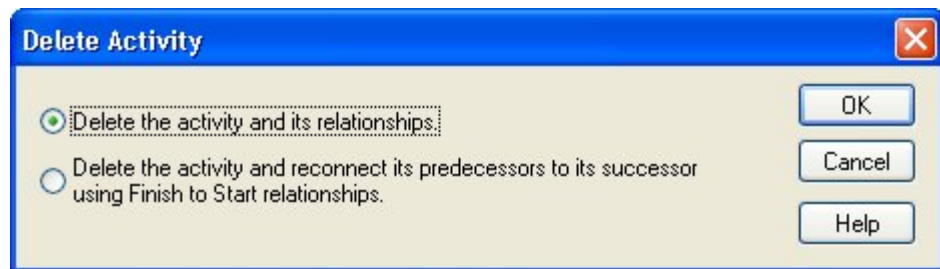

When you delete a single activity from a project, you can use this dialog box to instruct Open Plan to take one of the following actions:

- **Delete the activity and its relationships** — Removes the activity and relationships when the activity is not required and the chain of activities or the logic flow is changing.
- **Delete the activity and reconnect its predecessors to its successor using Finish to Start relationships** — Use this option when one step in a process is not needed but the rest of the work continues in its planned sequence. For example, this could be a work order with steps or a process with steps.

Setting Column and Row Attributes for a View

You may customize the display of the columns and rows for any spreadsheet or barchart view by using the **Set Column/Row Attributes** dialog box:

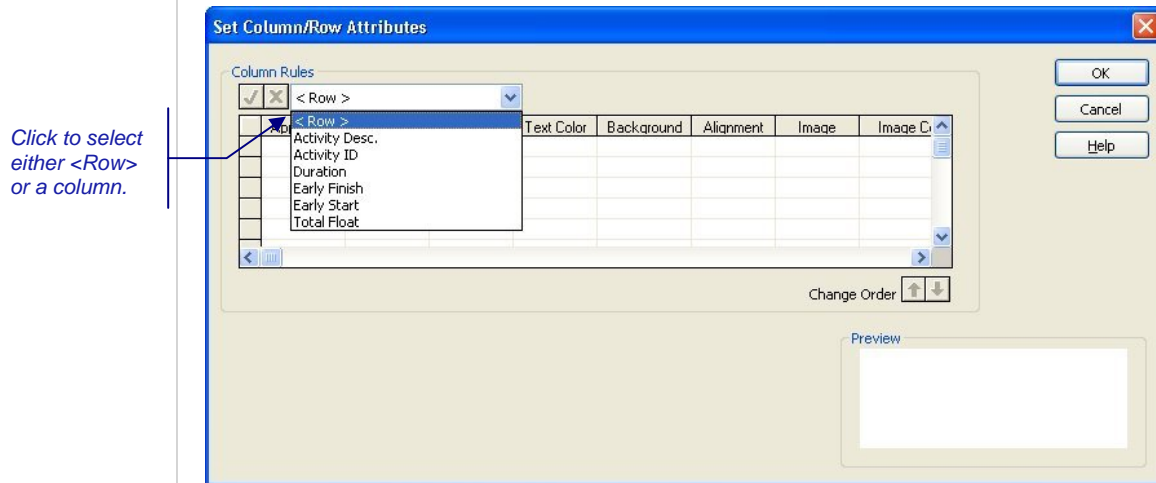

The following attributes may be changed for any column or row:

- **Font** — select a font, font style, size, and/or script
- **Text color** — select from the color palette
- **Background** — select from the color palette
- **Alignment** — select either center, left or right

The following attributes may be changed only in columns:

Example of possible selections for <Row>.

- **Image** — select the appropriate symbol from either the drop-down list or the Manage Symbols dialog box
- **Image Context** — select one of the following:
 - **adjacent to data** — both data and symbol are displayed in the same cell;
 - **centered in cell** — data is superimposed on the symbol which is centered; or
 - **replaces data** — only symbol is displayed

Example of possible selections for a column.

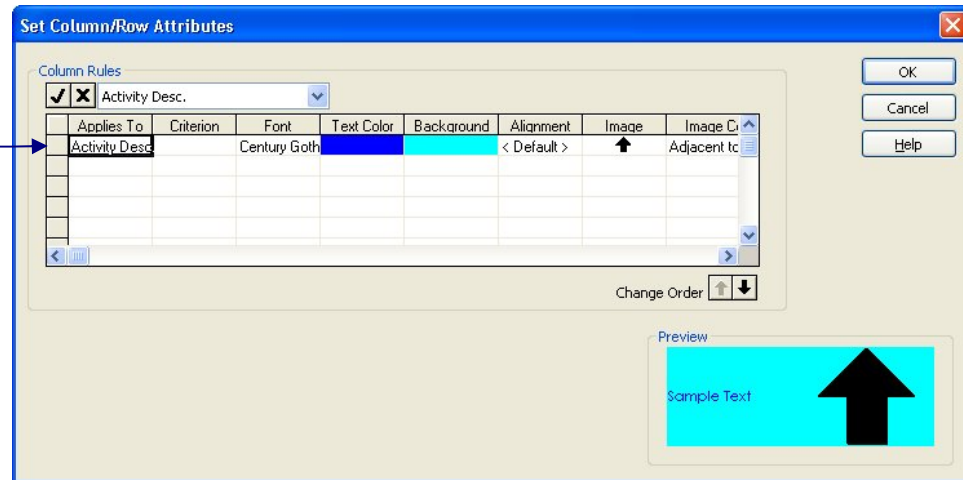



If < Row > is selected in the drop-down list and the **Criterion** field is blank, all formatting selections will be applied to every row. If the **Criterion** field contains a value, formatting selections will be applied only to rows for which the criterion evaluates to True.

The **Criterion** field may contain one of the following:



- A calculated field that evaluates to a Boolean (True/False) value or a filter
- An on-the-fly expression that evaluates to a Boolean
- A blank, indicating that the rule will be unconditionally applied

When previewing, you may see the cumulative effect of multiple rules being applied by selecting multiple rows in the dialog box. You can press CTRL+click to select non-adjacent rows.

If a column name is selected in the drop-down list, all formatting selections will be applied to only that column.

The order of rows in the **Column Rules** table may be changed by selecting the desired row and then using either  or  to move the row up or down. Rules are evaluated in sequential order. Individual attributes with a value other than <Default> will replace the current attribute.

As each cell in the spreadsheet is drawn, only column rules that reference the current column or row rules are evaluated (e.g., if an "Activity Description" cell is being drawn, rules for the "Activity ID" column are ignored).

Click  to accept a selection. Click  to cancel a selection.

To set a column or row attribute

1. Open the view you want to customize.
2. Click **Set Column/Row Attributes** on the **Edit** menu.
3. In the **Column Rules** area, select the column/row to be formatted from the drop-down list. (In the graphic above, < Row > is displayed by default.)
4. Once you have selected a row or column to format, you may choose a criterion or other attribute to modify on the same row.

5. To make a formatting selection, click the drop-down list and/or the ellipsis box (if present).
6. When finished making selections, click **OK**.

7

Resource Definitions

➤ Overview	169
➤ Resources in Open Plan	170
➤ Resource Files	171
➤ Defining Resources.....	174
➤ Reserving Resources for Projects	186
➤ Entering Resources.....	188
➤ Resource Skills	192
➤ Displaying Resource Information	196
➤ Resources in Spreadsheet and Barchart Views	201

Overview

Resources are people, facilities, or anything else needed to perform the work of a project. Although entering resources is not required in Open Plan, many project managers have found that the successful planning, management, and control of project resources are crucial to the overall success of a project.

In Open Plan, features related to resource management fall into three broad categories:

- Defining resources
- Assigning resources to activities
- Performing resource scheduling

This chapter includes discussions on the first of these categories — defining resources.



For information about assigning resources, refer to Chapter 8, “Resource Assignments”. For information about resource scheduling, refer to Chapter 14, “Resource Scheduling.”

Resources in Open Plan

Resources in Open Plan use a self-defining coding structure in which periods within the resource codes are used to distinguish between different hierarchical levels. This type of structure is sometimes referred to as a “resource breakdown structure” (RBS).

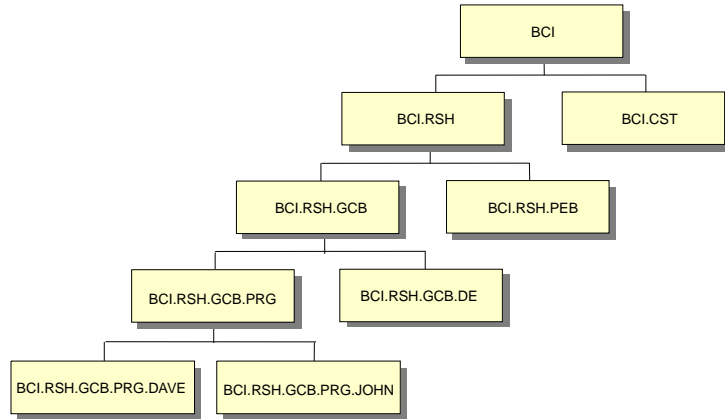

A higher-level resource is referred to as a “resource pool” in Open Plan. With resource pools, you can roll up resource availabilities, assignments, and usage for reporting purposes. However, information entered at the pool level (for example, availability levels or unit costs) is not inherited by the members of that pool.

Resource Files

In Open Plan, information about a group of resources is stored in a resource file. (In reality, this information is stored in three separate data tables. For the purposes of this discussion, however, we will refer to these as comprising a single file.) Resource files can be project-specific, or they can be shared among multiple projects. However, you can assign only one resource file to a project at any given time.

If you make changes to the information in a resource file, the changes will affect all of the projects to which that file is assigned. To make changes in a resource file that affect a single project only, make sure that the resource file is not assigned to other projects.

In Open Plan, resource files are represented with a distinctive icon.

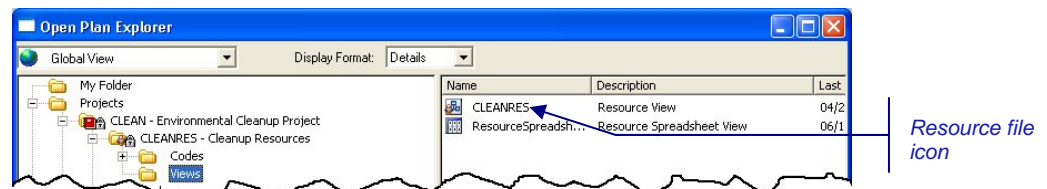

You can open a resource file from within the resource's **Views** folder. Assigning a resource file to a project can be as simple as dragging the resource file from the Open Plan Library to the project folder.

To create a resource file

- Take one of the following actions:
 - On the **File** menu, click **New**.
 - On the toolbar, click the **New** button.
 - Press **Ctrl+N**.
 - Double-click an empty area of the Open Plan Explorer.
- From the **File Type** list on the **New File** dialog box, select **Resource**.
- Enter a name and description for the new resource file.
- Select Use previous settings as defaults if you wish to create the new resource file using the same settings as the previous file.
- Click **Next** to start the **New File Wizard** where you can define the settings for the resource file, or click **Finish** to create the resource file with default settings or with previous settings.

Open Plan creates a new resource file and allows you to enter information for the first resource.



For more information on using the **New File Wizard**, refer to Chapter 4, "Creating a New File."

To open a resource file

- Take one of the following actions:

 New button



Open button

- Right-click the resource folder, point to **Open** on the context menu, and select the mode in which to open the resource file.
- On the **File** menu, click **Open**, and use the **File Open** dialog box to locate the resource.
- On the toolbar, click the **Open** button, and use the **File Open** dialog box to locate the resource.



For information on using the **File Open** dialog box, refer to Chapter 3, “Getting Started.”

To copy a resource file

1. Open the resource file.
2. On the **File** menu, click **Save As**.
3. In the **Save As** dialog box, enter the name for the copy of the file, and click **OK**.



You cannot perform **Save As** on a file if there is another file open which refers to it. For example, if you open project CLEAN and then try to perform a **Save As** on the resource file CLEANRES, the **Save As** command is disabled.

To delete a resource file from a project

1. From the target project folder, select the resource folder.
2. Press the **Delete** key.
3. When Open Plan asks you to confirm the deletion, click **Yes**.



Deleting a resource file from a project removes any activity resource assignments from the project.

To delete a resource file from the database



You cannot delete a data file that is referenced by another file. For example, you cannot delete a resource file if any project still uses it.

1. Display the **Select File to Delete** dialog box with one of the following actions:
 - On the file menu, point to **Manage Files**, and click **Delete File** on the submenu.
 - Right-click the resource folder, point to **Manage Files**, and click **Delete File** on the submenu.
2. On the **Select File to Delete** dialog box, locate the appropriate resource file, and click **OK**.



For more information on using the **Select File to Delete** dialog box, refer to Chapter 3, “Getting Started.”

To assign a resource file to a project

1. Take one of the following actions:
 - Drag the resource file from the Open Plan Library to the project folder.
 - Specify the name of the resource file on the **Files** tab of the **Project Properties** dialog box.

Defining Resources

To define a resource in Open Plan, use the **Resource Details** dialog box. The **Resource Details** dialog box displays basic information about each resource. Open Plan automatically displays this tabbed dialog box each time you add or edit a resource.

The **Resource Details** dialog box contains the following tabs for the various types of information associated with the resource:

- General tab
- Code tab
- Availability tab
- Escalation tab
- Skills tab
- User Fields tab
- Notes tab

You can display the **Resource Details** dialog box for an existing resource in the following ways:

- By double-clicking the resource
- Selecting the resource and clicking **Edit Resource** on the **Edit** menu
- Right-clicking the resource and clicking **Edit** on the context menu

The **Resource Details** dialog box is also displayed when you create a new resource by taking one of the following actions:

- Double-clicking an empty area of the view
- Pressing **Ctrl+A**
- Clicking **Add Resource** on the **Edit** menu
- Right-clicking an empty area of the view and clicking **Add Resource** on the context menu

Because you can update multiple resources without having to close the **Resource Details** dialog box each time, Open Plan automatically saves any changes you make to a resource before displaying the next record. Notice also that the **OK** and **Cancel** buttons usually found on dialog boxes have been replaced with the following buttons:

- **Close** — This button closes the dialog box and returns to the display of resources. If you have not saved the information currently displayed, Open Plan saves the changes before returning to the display.
- **Undo** — Provided that you have not clicked **Apply**, this button returns the dialog box to its previous state.
- **Apply** — This button saves the changes you have made to the current record.



You must enter information for a resource before the **Undo** and **Apply** buttons become active.

You can also use the **New** command to create a new resource while the **Resource Details** dialog box is open. This command functions identically to the **Add Resource** command available from the **Edit** menu.

General Resource Information

The **General** tab of the **Resource Details** dialog box displays the basic information about each resource:

The screenshot shows the 'Resource Details [CLEANRES]' dialog box with the 'General' tab selected. The fields are as follows:

- ID:** RES.LAB.ENG.CIV.JIM
- Desc:** Jim Armstrong
- Type:** Normal (dropdown)
- Category:** Labor (dropdown)
- Unit:** labor-hr
- Effort Factor:** 1
- Unit Cost:** 50
- Employee ID:** (empty field)
- Threshold:** 0
- Project:** <None> (dropdown)
- Email Address:** (empty field)

Checkboxes at the bottom:

- Suppress in Lists
- Suppress for Scheduling
- Roll up for Scheduling
- Progress Based on Activity Progress
- Actual Cost Based on Progressed Quantity
- Consider in Cost Calculations

Buttons at the bottom: Back, Forward, Close, Undo, Apply, New, Help.

For each resource, you can enter the following information:

- **ID** — A resource ID is an alphanumeric code unique to the resource and consists of from 1 to 59 characters, including periods that are used to indicate hierarchical levels.

By default, Open Plan defines a maximum field length of 59 characters for resource IDs and 60 characters for resource descriptions. It is possible, however, to modify the standard data structure and data dictionary so that these field lengths can be as long as 255 characters for new files.



For information about customizing the Open Plan standard data structure and data dictionary, contact the Deltek technical support staff.

When you enter a resource ID on the **Resource Details** dialog box, enter only the local portion of the resource ID. Open Plan automatically enters the parent portion of the ID.

Open Plan does not distinguish between upper and lower case characters in an ID and will flag resource R0001 as a duplicate of resource r0001.

- **Description** — You can enter an extended description of up to 60 characters for each resource.

- **Type** — Open Plan supports the following types of resources:
 - **Normal** — An individual resource that does not get “used up” (for example, a person or a facility).
 - **Consumable** — An individual resource that can be consumed or “used up” over the course of a project. Building materials such as bricks used in a construction project are a typical example of a consumable resource. Units of consumable resources that are not required during one period of availability are carried forward to the next period. For example, assume that the availability of bricks is defined as 3,000 units on a particular day. If the requirement for the bricks is only 2,000 units on that day, Open Plan carries forward the remaining 1,000 units to the next day. Open Plan assumes that the total quantity of a consumable resource is available on the date specified in the **From Date** field on the **Availability** tab, and that some quantity of the resource is available until it has been totally consumed or used up.
 - **Perishable** — Consumable resources with an expiration date. This type of resource is sometimes called “use it or lose it” and is frequently used to model budgets that cannot be carried forward past a particular date. When entering the availability of a perishable resource (on the **Availability** tab), enter dates in both the **From Date** and the **To Date** fields.
 - **Resource Pool** — A higher-level resource. It is important to be aware of which resources are serving as pools because of the following ramifications:
 - Information defined at the pool level (for example, availabilities or unit costs) is ignored by the child resources belonging to the pool.
 - If you delete a pool, you delete all child resources belonging to that pool as well.
 - **Unit** — For each resource, you can enter a description of how you measure the resource (for example, hours, tons, etc.).
 - **Unit Cost** — You can enter a cost per resource unit.
 - **Threshold** — Thresholds specify an additional number of units of availability for a resource that can be used to avoid project delays if necessary. The value of a resource threshold represents an incremental amount on top of all existing availabilities for that resource. Open Plan ignores thresholds for consumable resources.

Open Plan interprets a threshold value based on the default duration unit and the conversion settings for a project. For example, assume that you enter a threshold of 2 for a labor resource used in a project in which the default duration unit is defined as days and in which one day converts to 8 hours. Open Plan interprets the threshold for that resource as 16 labor-hours. Note that one implication of this approach is that the interpretation of a threshold value may vary since it depends on the settings stored on the **Preferences** tab of the **Project Properties** dialog box for the project.



For more information about the **Preferences** tab of the **Project Properties** dialog box, refer to Chapter 5, “Project Properties.”

- **Project** — This field contains a list of projects that are assigned to the resource file of the selected resource. If you select a project from the list, Open Plan reserves 100 percent of the resource's availability to the project.

Lower level reservations can override higher level ones. This allows you to reserve an entire resource pool for one project and then override this for resources at a lower level in the resource hierarchy.

If the selected resource is an individual resource (as contrasted with a pool) you can use the **Availability** tab to apportion the availability to multiple projects.



For more information on reserving resources, refer to the “Reserving Resources for Projects” section in this chapter.

- **Email Address** — You can use this field to store an email address for the resource. This information can be used as an **Address** field in the **Email Advisor**.
- **Category** — Open Plan supports the following resource category types:
 - Labor
 - Material
 - Other Direct Costs
 - Subcontract

Open Plan uses **Other Direct Costs** to monitor costs at an activity level.

- **Effort Factor** — The effort factor setting is used for the calculation of durations for effort-driven activities. The effort factor indicates to what extent the resource is available for any one activity. For example, assume that a resource, while available for 8 hours per day, cannot devote more than 4 hours of his or her time to any one activity. Enter an effort factor of 4 to reflect this situation.

This setting does not indicate efficiency and has no effect on resource scheduling calculations.



For a description of effort-driven activities, refer to Chapter 8, “Resource Assignments.”

- **Employee ID** — If the resource category is **Labor**, you can enter the employee ID used by the Human Resources Department in this field.
- **Suppress in Lists** — If you do not want to use the resource for assignment or reporting purposes, you can have Open Plan suppress the display of the resource in all lists.
- **Suppress for Scheduling** — You can have Open Plan ignore a resource during resource scheduling. This is useful in cases where you want to track requirements for a particular resource but ignore any potential impact it may have on the project schedule. During resource scheduling, Open Plan treats suppressed resources as though they have unconstrained availabilities.
- **Roll up for Scheduling** — Roll-up resource scheduling allows you to look at resources and schedule the activities from a summary perspective by specifying the hierarchical level for resource availabilities and assignments. When you indicate that the resource is to be rolled up for scheduling purposes, you specify that all references to that resource should be treated as a reference to the first parent of the resource in the hierarchy that is not rolled up to a higher level. (Thus, every rolled-up resource must have at least one

hierarchical parent that is not rolled up.) The only restriction to this technique is that you cannot roll up both consumable and non-consumable resources to the same pool.

Using this feature, you can produce a more general resource schedule without a detailed consideration of individual resources. This effectively reduces the number of calculations required to produce a resource-based schedule, thereby improving processing times for larger projects.

For example, assume that MARY and JANE are individual resources in the following hierarchy:

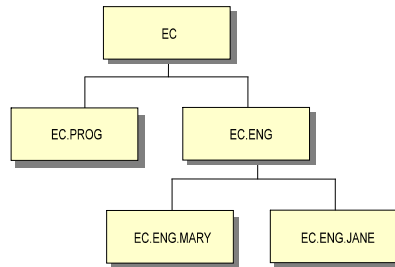

The roll-up settings for these resources have been defined as follows:

Resource	Availability	Roll-up
EC	Not defined	No
EC.PROG	Not defined	No
EC.ENG	Not defined	No
EC.ENG.MARY	8 hours/day	Yes
EC.ENG.JANE	8 hours/day	Yes

EC.ENG is the first parent of MARY and JANE that is not rolled up to a higher level. Therefore, Open Plan considers any request for either MARY or JANE as a request for EC.ENG. Furthermore, Open Plan assumes that EC.ENG has an availability of 16 hours per day since it combines the availabilities of both MARY and JANE.

This roll-up feature is incompatible with the use of alternate resource assignments involving pools and skills.



For information about alternate resource assignments, refer to Chapter 8, "Resource Assignments."

- **Progress Based on Activity Progress** — Use this option to automatically progress the resource based on the schedule status of the activity. For example, if you have statused the activity as 50% complete, Open Plan assumes that the resource assignment corresponding to the first half of the activity duration has occurred as planned.



For information about entering resource progress, refer to Chapter 16, "Status Information."

- **Actual Cost Based on Progressed Quantity** — Use this option if you want Open Plan to automatically calculate actual costs from the number of resource units used. For example, if you define the unit cost for a resource as \$10.00, and you indicate that 5 units of the resource have been used, then Open Plan calculates the actual cost for the resource as \$50.00.



For information about calculating actual costs automatically, refer to Chapter 10, “Cost Information.”

- **Consider in Cost Calculations** — If this option is selected, Open Plan includes the resource in cost calculations.

Resource Codes

Resource codes are designed to summarize or manage an entire group of resources. Codes can be predefined, then assigned to resources within the resource file. The ability to create custom reports based on user-defined coding structures provides virtually unlimited reporting possibilities.

The **Code** tab of the **Resource Details** dialog box allows you to assign codes to resources:

The screenshot shows the 'Resource Details [CLEANRES]' dialog box with the 'Code' tab selected. The 'ID' field contains 'RES.LAB.ENG.CIV.JIM' and the 'Desc' field contains 'Jim Armstrong'. Below the description field is a small table with two columns: 'Code' and 'Value'. The table is currently empty. At the bottom of the dialog are several buttons: 'Close', 'Undo', 'Apply', 'New', and 'Help'. There are also navigation arrows on the left side of the bottom bar.

You can use the following settings to control the code assignments:

- **Code** — The code field in the resource table to which a code file is assigned. For example, many organizations use WBS and OBS code files.
- **Value** — The specific code within the code file. Clicking the **ellipsis** at the right edge of the input field displays the **Select Code** dialog box that you can use to select a code from a hierarchical code structure.

Resource Availabilities

Availability information defines periods during which a resource is available and in what quantity. To represent more complex resource availabilities, you can define multiple availability levels for a single resource. This allows you, for example, to model how seasonal changes in your staffing levels can affect the project schedule.

The **Availability** tab of the **Resource Details** dialog box displays information about the availability of each resource:

Availability	From Date	To Date	Calendar
8.00	01/02/2003	06/15/2003	1
8.00	07/01/2003	12/31/2005	1

To define the availability for a resource, use the following settings:

- **Availability** — The availability of each resource is defined as the number of resource units available each period for a specified span of time. Open Plan interprets the availability by examining the calendar assigned to the resource. For example, if you define the availability of a labor resource as 1 unit and the availability calendar defines each working day as comprising 8 hours, then 8 labor-hours (or 480 labor-minutes) of the resource are available each working day. Note, however, that the interpretation of the calendar depends on the calendar file that is assigned to the resource file.
- **From Date** — The **From Date** is the first date on which the resource is available.
- **To Date** — The **To Date** is the last date on which the resource is available.
- **Calendar** — A calendar specifies that the resource is available only for valid working times in that calendar. The list of calendar names displayed comes from the calendar file associated with the resource file. If no calendar is specified for the availability, the resource is assumed to be available according to the definition of the default calendar for the resource file. The resource calendar is ignored for consumable resources.

In certain cases, it may be impossible to schedule an activity if its calendar differs from that of one or more required resources.



For more information about how calendars affect resources, refer to Chapter 10, "Resource Scheduling Calculations," in the *Deltek Open Plan Developer's Guide*.

- **Project** — Selecting a field in this column displays a list of projects stored in the same data source for which the resource can be reserved for the date range.

If you do not specify a project for a particular period, Open Plan reserves the resource for that period to the project specified on the **General** tab of the **Resource Details** dialog box.

Consumable and Perishable Availabilities

If you are defining the availability of a consumable or a perishable resource, Open Plan treats information in the **Availability**, **From Date**, and **To Date** fields slightly differently than for normal resources.

- For normal resources, Open Plan considers the **Availability** quantity to be available in the period defined by the **From Date** and the **To Date**, both of which are required.
- For consumable resources, Open Plan considers the total **Availability** quantity to be delivered on the **From Date** and to be available until used up.
- For perishable resources, Open Plan considers the total **Availability** quantity to be delivered on the **From Date** and any quantity remaining to be no longer available after the **To Date**.

Interpreting Zero Availabilities

For any particular resource, there will be certain periods in which the availability is zero. The way in which these periods are entered in the resource definition has ramifications during resource scheduling.

Open Plan defines two types of zero availability: hard zeros and soft zeros. In the case of hard zeros, a zero availability is treated as an absolute, indicating that the resource is not available during that period under any circumstances. In the case of soft zeros, the availability can be exceeded when necessary during time-limited resource scheduling.

- In Open Plan, the gaps between specified availability dates can be treated as either hard zeros or soft zeros depending on whether the hard zeros processing option is in effect during resource scheduling.
- Open Plan treats a specific availability of zero as a soft zero, allowing the resource to be scheduled during that period if necessary.



For further information about the hard zeros processing option, refer to Chapter 14, "Resource Scheduling."

Cost Escalations

The cost escalations feature in Open Plan allows you to model the effects of changes in the unit cost of a resource over time. With this feature, you use the **Escalation** tab of the **Resource Details** dialog box to specify multiple unit costs for a resource and when each new cost takes effect:

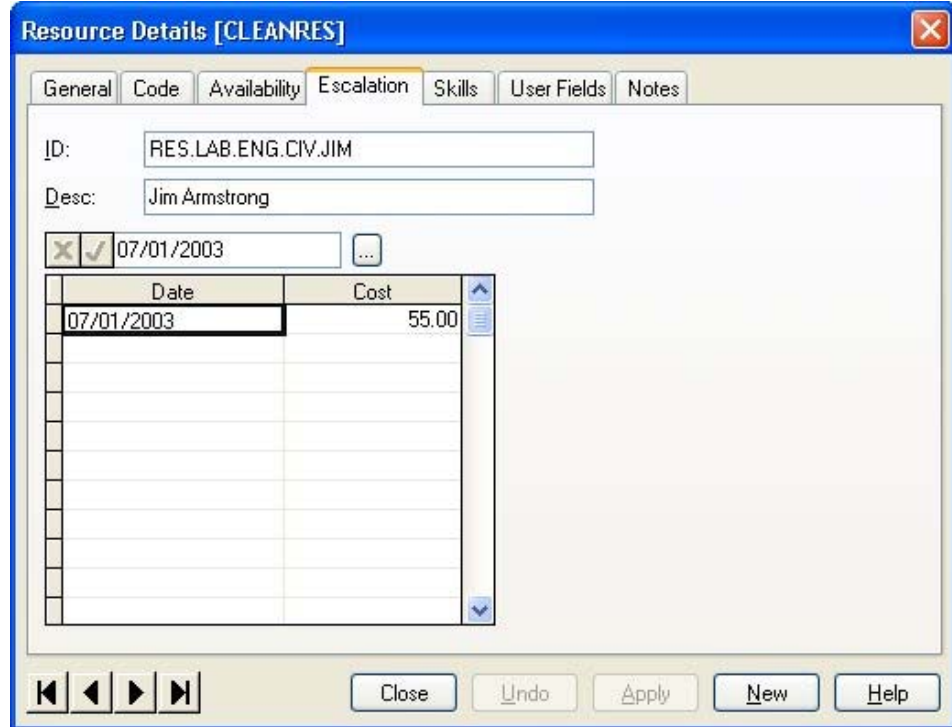

For example, assume that a resource costs \$25.00 per unit as of 01Jan04, and the cost escalates by \$.50 every three months. Enter \$25.00 as the current unit cost and describe the cost escalation with the following information:

Date	Cost
01Apr04	25.50
01Jul04	26.00
01Oct04	26.50
01Jan05	27.00

User-Defined Fields

The **User Fields** tab allows you to specify the values that Open Plan should include for user-defined fields on the project table:



User-defined fields are created on the project table outside of an open project and may be used by any project stored in the database. In order to use a user-defined field in your project, you must specify a value for it on this tab.

Resource Details [CLEANRES]

General Code Availability Escalation Skills **User Fields** Notes

ID: RES.LAB.ENG.CIV.JIM

Desc: Jim Armstrong

Field	Value
User Character Field 1	
User Character Field 2	
User Character Field 3	
User Character Field 4	
User Character Field 5	
User Date Field 1	
User Date Field 2	

Close Undo Apply New Help

This tab features a grid containing two columns:

- **Field** — This column displays a list of all the user-defined fields that have been defined for the project table.
- **Value** — For each user-defined field that you want to use in your project, you should enter an appropriate value.

For example, if the **Field** is Proj_Sec, you might enter the name of the project secretary as the value for the field.



For information on creating user-defined fields, refer to Chapter 23, "Project Utilities."

Resource Notes

The **Notes** tab allows you to attach text information to resources:

The screenshot shows a window titled "Resource Details [CLEANRES]" with a close button in the top right. The "Notes" tab is selected. The fields are as follows:

- ID:** RES.LAB.ENG.CIV.JIM
- Desc:** Jim Armstrong
- Note:** abc
- Category:** < Default >

Below the Note field is a large empty text area. At the bottom of the window are navigation arrows and buttons for Close, Undo, Apply, New, and Help.

You can use the following fields to attach a note to a resource:

- **Note** — This text box can contain up to 29 KB of text. You can enter the text by typing directly in this field or by using the Windows **Cut (Ctrl+X)**, **Copy (Ctrl+C)**, and **Paste (Ctrl+V)** commands to insert text from another Windows application such as a word processor or spreadsheet.
- **Category** — This field controls the category of the note. You can select a category from the list of global categories.

Clicking the **abc** button checks the spelling of the text you enter.

You can enter links to files, Web pages, and e-mail addresses by entering the information in one of the following formats:

- File links must be entered in the format of: <file://c:\document.doc>



If the file link you enter contains spaces, you must enclose the link with angle brackets (< >) in order for the link to work properly: **<file://C:\Documents and Settings\All Users\Desktop\test.txt>**

- Universal Resource Locators (URLs) must be entered in the format of: **http://deltek.com**
- E-mail addresses must be entered in the format of: <mailto:sales@deltek.com>



While you can use drag and drop functionality to create links in the **Note** field, the Windows **Cut (Ctrl+X)**, **Copy (Ctrl+C)**, and **Paste (Ctrl+V)** commands are not available for links.

Reserving Resources for Projects

Resources can be reserved for use with particular projects. This can be done at any level in the resource hierarchy. For example, you can reserve a whole department or an individual resource for a project. When you reserve an individual resource, you have two options:

- Reserving a resource completely
- Reserving a portion of a resource

If you are reserving an individual resource, as opposed to a resource pool, the resource can be reserved for a particular period of time and/or at a partial level. Thus an individual might have 50% of his time reserved for a given project during a specific 6-month period.

To reserve an individual resource or branch of the resource hierarchy completely:

1. In the resource view, double-click the resource to be reserved.
2. On the **Resource Details** dialog box, click the **General** tab.
3. From the **Project** field list, select the project for which you want to reserve the resource.
4. Click **Close**.

To reserve a portion of an individual resource's availability:

1. In the resource view, double-click the resource to be reserved.
2. On the **Resource Details** dialog box, click the **Availability** tab.
3. In the **Project** column, specify the project to which you want to reserve the resource.
4. Click **Close**.

Lower-level reservations override higher-level ones. For example, you can reserve a whole department for a particular project by assigning a project on the **General** tab for a resource pool. Then you can countermand this for individual members of that department (or pool) by one of two ways:

- Assign a different project on the **General** tab for that particular resource
- Assign a different project in the **Project** column on the **Availability** tab



Since a lower-level reservation takes precedence over the higher-level one, a child resource reservation is checked before the parent resource pool. Open Plan first checks for a reservation on the **Availability** tab. If a reservation is found then the search ends. If not, the **General** tab is checked. If no reservation is found in either spot, the parent reservation is used.

Effect of Reservations on the Select Resource Dialog Box

The availability levels shown on the **Select Resource** dialog box do not include any resource availability reserved for another project.

When an activity belongs to an external subproject, the availability shown includes:

- The availability reserved for that subproject
- The availability for any higher-level external subprojects to which it belongs
- The availability of the main project.

Entering Resources

When you create a new resource file, Open Plan displays a window containing an empty workspace. To add a resource to the file, click the **Add Resource** command on the **Edit** menu or simply double-click an empty area in the workspace.

Although you can define a resource file as a “flat” structure in which all resources occupy the top hierarchical level, a more common practice is to develop a tree-like resource breakdown structure that can be used to summarize groups of related resources for reporting purposes:

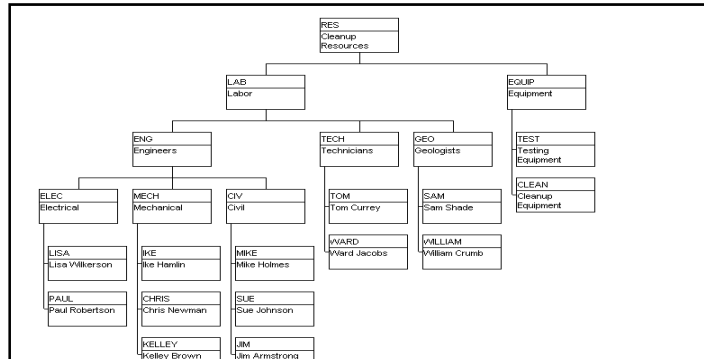

Open Plan makes it easy to work with hierarchies of resources. For example, you can assign an entire group of resources to a different resource pool simply by dragging the resources to a different position in the resource hierarchy. You can also expand and collapse individual resource pools in order to display the appropriate level of detail.

To add a resource

1. Take one of the following actions:
 - From the resource display, click **Add Resource** on the **Edit** menu.
 - Double-click an empty area of the workspace.
 - Right-click an empty area of the workspace, and click **Add Resource** on the context menu.
2. Enter the information for the resource in the **Resource Details** dialog box.
3. When the information is complete, click **Close**.



You can rearrange the order in which Open Plan displays resources from left to right on the same hierarchical level by simply dragging a resource to the desired location.

To add a child resource

1. Take one of the following actions:
 - Select the resource pool to which you want to add a child, and click **Add Resource** on the **Edit** menu.
 - Right-click the resource pool to which you want to add a child, and click **Add Child** on the context menu.
 - Double-click the resource pool while holding down the **Shift** key.



If you add a child to a normal resource, Open Plan automatically converts the resource to a resource pool.

2. In the **Resource Details** dialog box, enter the information for the resource.
3. When the information is complete, click **Close**.

To edit a resource

1. Take one of the following actions:
 - Double-click the resource you want to update.
 - Select the resource you want to update, and click **Edit Resource** on the **Edit** menu.
 - Right-click the resource, and click **Edit** on the context menu.
2. In the **Resource Details** dialog box, enter the information for the resource.
3. When the information is complete, click **Close**.

To find a resource

1. Take one of the following actions:
 - On the **Edit** menu, click **Find**.
 - Right-click an empty area of the workspace, and click **Find** on the context menu.
2. In the **Find Node** dialog box, enter the ID of the resource you want to find, and click **OK**.

To delete a resource

1. Select the resource you want to delete.
2. Take one of the following actions:
 - Press the **Delete** key.
 - On the **Edit** menu, click **Delete Resource**.
 - Right-click the resource, and click **Delete** on the context menu.

If you are deleting a resource pool, Open Plan warns you that the child resources will be deleted along with the pool.



If you delete a resource that has been assigned to an activity in a project, the assignment is deleted as well.

To move a resource in the hierarchy

1. Drag the resource to the desired position in the resource hierarchy.
If you move a resource pool, all child resources of the pool are moved as well.



When you move a resource (or group of resources) to a different position in the resource hierarchy, Open Plan automatically renumbers the resource IDs of the moved resources. If this renumbering duplicates existing resource IDs, Open Plan allows you to renumber the resources yourself. In addition, Open Plan also updates the assignments for renumbered resources in any projects that are open at the time of the move. (Assignments in closed projects are not affected.)

To collapse a resource pool

1. Select the resource you want to collapse.
2. Take one of the following actions:
 - On the **View** menu, select **Collapse**.
 - Right-click the resource, and select **Collapse** on the context menu.
 - On the toolbar, click the **Collapse** button.

 Collapse button

To collapse all resource pools

1. Take one of the following actions:
 - On the **View** menu, click **Collapse All**.
 - On the toolbar, click the **Collapse All** button.

 Collapse All button

To expand a resource pool

1. Select the resource you want to expand.
2. Take one of the following actions:
 - On the **View** menu, click **Expand**.
 - On the **View** menu, clear **Collapse**.
 - Right-click the resource, and clear **Collapse** on the context menu.
 - On the toolbar, click the **Expand** button.

 Expand button

To expand all resource pools

1. Take one of the following actions:
 - On the **View** menu, click **Expand All**.
 - On the toolbar, click the **Expand All** button.

 Expand All button

Automatic Numbering within a Resource View

Resource IDs can be generated automatically from within a resource view. If you leave the ID field blank on the **Resource Details** dialog box when creating a new resource, Open Plan generates an ID for the new item automatically according to the following rules:

- If the previous resource ID at a given level is all alphabetic, the program increments alphabetically.
- If the previous resource ID at a given level is a mixture of alphabetic and numeric characters, the numeric part is incremented numerically.
- If there is no previous resource ID, the program uses a numeric ID. Therefore, the first ID in the file is numbered "1."

Open Plan attempts to find a pattern in the ID numbering scheme for IDs that are incremented numerically by looking at the last two IDs in the hierarchy. If a pattern can be established, Open Plan uses the pattern when automatically creating a new ID.

For example, assume that your resource file has the following hierarchy:

A11
A12
A13
A14
A15
A20

Open Plan looks at the last two IDs in the hierarchy and determines that there is a difference of 5 between the two. Therefore, if you use automatic numbering to create the next ID, Open Plan creates ID A25.

On the other hand, if there is only one resource ID in the hierarchy and you have Open Plan create the other IDs, it uses the ID's value as the incremental pattern.

For example, if you enter 12 for the first ID in the hierarchy and then have Open Plan create the remaining IDs, it increments the IDs by 12 resulting in the following hierarchy:

12
24
36
48
60



For information on using automatic numbering when creating new resources in a spreadsheet view, refer to Chapter 20, "Spreadsheet Views." For information on using automatic numbering when creating new codes in a code view, refer to Chapter 11, "Project Codes."

Resource Skills

A skill is an attribute of an individual resource, which can have any number of skills. In general, the skills assigned to different individual resources will be different but overlapping. Furthermore, skill sets can cross hierarchical boundaries within an RBS. Thus, an individual resource may have a different set of skills than other resources in its pool while sharing skills with resources belonging to another pool.

Just as you can define resource assignments for an activity, Open Plan allows you to define skill assignments as well. These assignments can be satisfied by any individual resource that possesses the required skill.

For example, assume the following set of resources and skills:

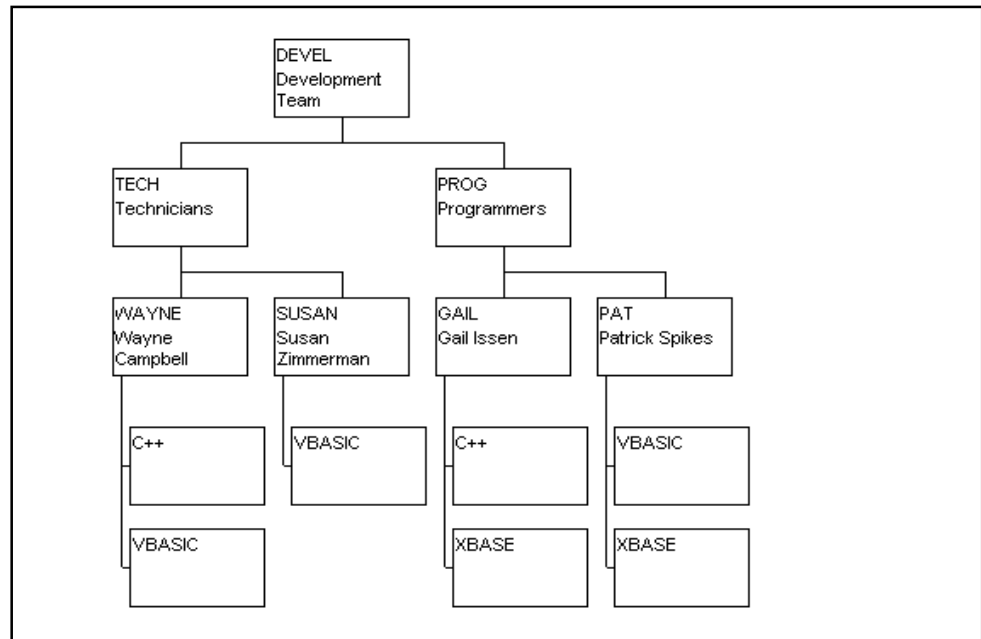

For an activity requiring a knowledge of C++, Open Plan could suggest either DEVEL.TECH.WAYNE or DEVEL.PROG.GAIL.

To use resource skills in Open Plan, perform the following steps:

- **Step One** — Define the skills in a resource file.
- **Step Two** — Assign skills to individual resources.
- **Step Three** — Define skill assignments for activities.

To define skills for a resource file, use the **Manage Skills** command from the **Tools** menu. Open Plan displays any skills assigned to resources at the bottom level of the resource breakdown structure.

Managing Skills

The **Manage Skills** command from the **Tools** menu allows you to set up the skills for a resource file:

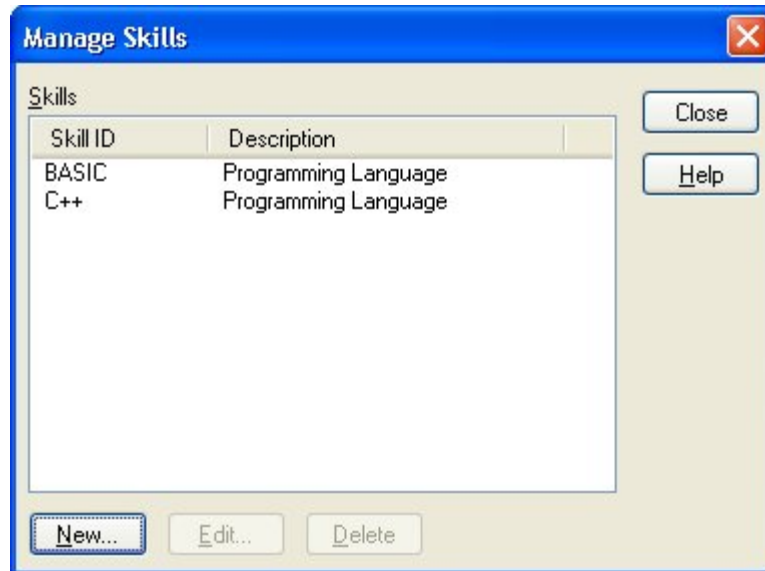

When you indicate that you want to create a new skill, Open Plan displays the following dialog box:

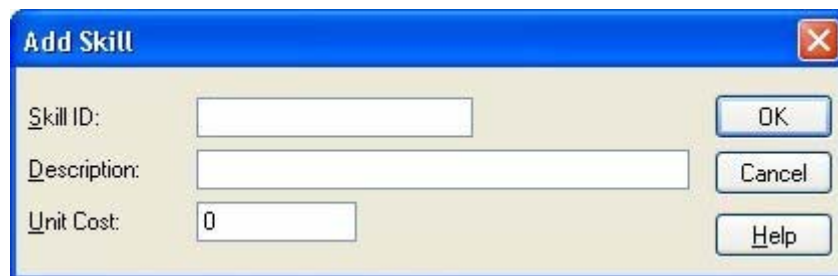

Use the following settings to define each new skill.

- **Skill ID** — A skill ID is an alphanumeric code unique to the skill and cannot exceed 10 characters.
- **Description** — You can enter an extended description of up to 60 characters for each skill.
- **Unit Cost** — A base cost for the skill. Typically, this is the average cost of all the resources that possess the skill.



By defining costs for skills, you can calculate resource budgets in cases where you request a skill rather than an individual resource for an activity.

To define a new skill

1. From the resource display, click **Manage Skills** on the **Tools** menu.
2. On the **Skills** dialog box, click **New**.
3. Enter the information about the skill.
4. When the information for the skill is complete, click **OK** to return to the **Skills** dialog box.
5. To return to the resource display, click **Close**.

To update a skill

1. From the resource display, click **Manage Skills** on the **Tools** menu.
2. From the list of skills, select the skill you want to update, and click **Edit**.
3. Update the information about the skill.
4. When the information for the skill is complete, click **OK** to return to the **Skills** dialog box.
5. To return to the resource display, click **OK**.

To delete a skill

1. From the resource display, click **Manage Skills** on the **Tools** menu.
2. From the list of skills, select the skill you want to delete, and click **Delete**.
3. When Open Plan asks you to confirm the deletion, click **Yes** to perform the operation and return to the **Skills** dialog box.
4. To return to the resource display, click **OK**.

Assigning Skills

Once you have created the skills for a resource file, you can assign these skills to resources. Information about the skills assigned to a resource appears on the **Skills** tab of the **Resource Details** dialog box:

The screenshot shows the 'Resource Details [CLEANRES]' dialog box with the 'Skills' tab selected. The 'ID' field contains 'RES.LAB.ENG.CIV.JIM' and the 'Desc' field contains 'Jim Armstrong'. A list of skills is shown with 'BASIC - Programming Language' selected. Below this is a table with columns 'Skill' and 'Proficiency'.

Skill	Proficiency
BASIC	

You can assign one or more skills to any individual resource in a resource file.

To assign skills to a resource

1. Select the resource for which you want to enter a skill assignment.
2. Display the **Resource Details** dialog box.

3. Click the **Skills** tab.
4. Enter the information for the skill assignment, and click **Close**.

Displaying Resource Information

Open Plan provides a number of features related to the display of resource information:

- Display options
- Box layout definition
- The **Zoom Out** and **Zoom In** commands

Each of these features is described in the following sections.

Defining Display Options

To define the display options for resource information, use the **Options** tab of the **Resource Display Preferences** dialog box:

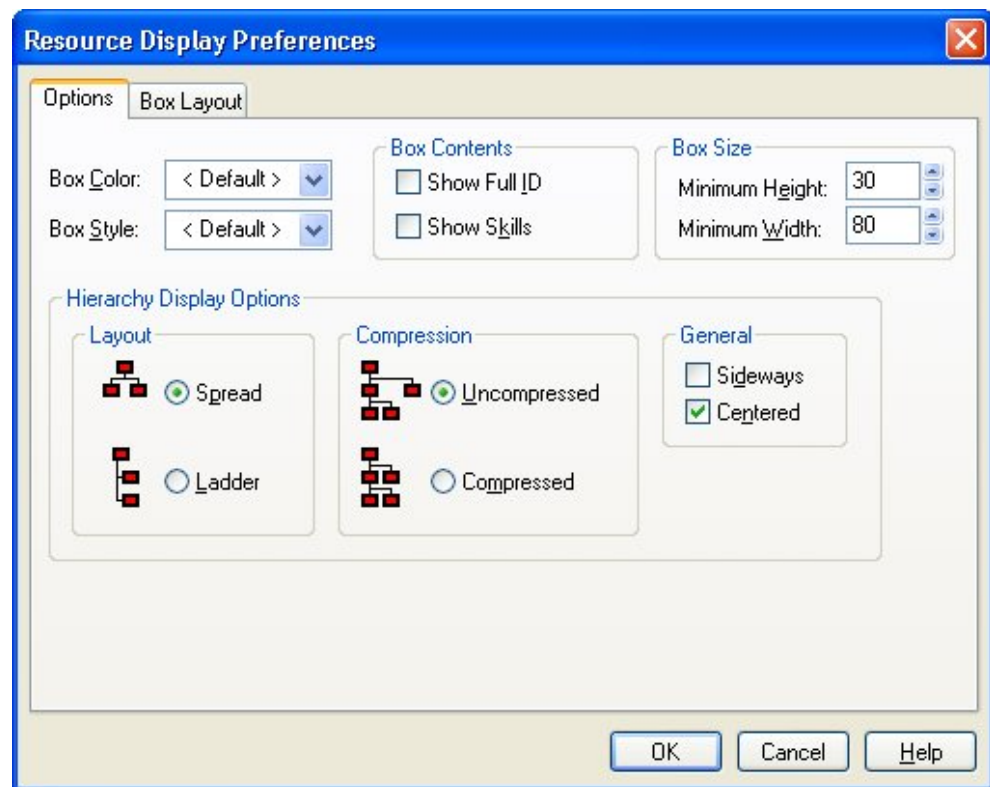

Use this dialog box to specify the following options for displaying resource information:

- **Box Color** — The color used to draw the resource boxes.
- **Box Style** — The style used to display the resource boxes. Open Plan allows you to select a box style from a list displayed when you enter the field.
- **Show Full ID** — You can display the entire resource ID or just the local portion of each ID.
- **Show Skills** — You can control the display of skills. (Skills appear as children of individual resources.)
- **Minimum Height** — You can control the height of the resource boxes.

- **Minimum Width** — You can control the width of the resource boxes
- **Spread/Ladder** — You can display the lowest level of the resource hierarchy in a “ladder” format to conserve horizontal space.
- **Compressed/Uncompressed** — You can display the resource hierarchy in a compressed mode in which individual resources belonging to one pool can be displayed beneath another pool.
- **Sideways** — You can display the resource hierarchy in a horizontal orientation.
- **Centered** — You can display the resource hierarchy centered in the workspace, or left-justified. (If you are displaying the hierarchy using the **Sideways** option, turning off the **Centered** option results in the resources being aligned along the top of the workspace.)

To define resource display options

1. Take one of the following actions:
 - On the **Tools** menu, click **Preferences**.
 - Right-click an empty area of the workspace, and click **Preferences** on the context menu.
2. On the **Options** tab of the **Resource Display Preferences** dialog box, enter the information for the display options.
3. When the information is complete, click **OK** to return to the display.

Customizing Box Layout

If you are using the Professional edition of Open Plan, you can define which resource fields are displayed when you view a resource hierarchy. Boxes can contain as many as 50 different data items, displayed on a maximum of 20 lines. You can also display blank lines in a box.

To customize the layout of resource boxes, display the **Box Layout** tab of the **Resource Display Preferences** dialog box:

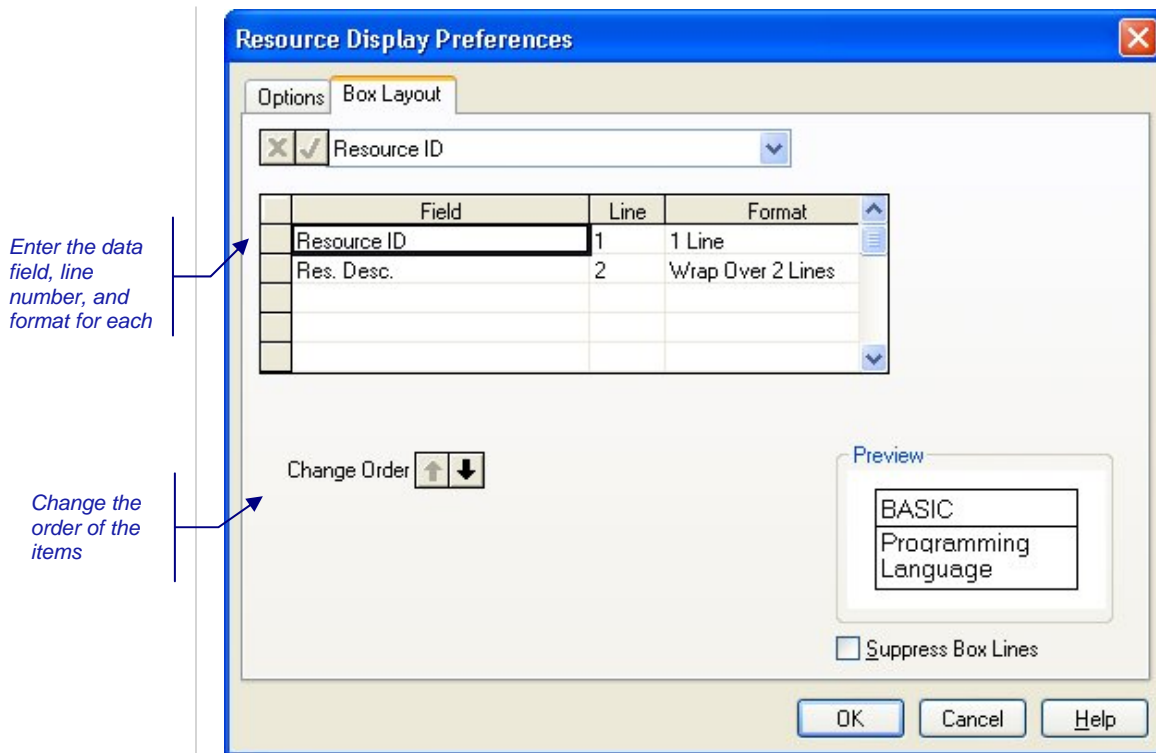

Enter the data field, line number, and format for each

Change the order of the items

The preview area of the dialog box displays the current definition of the resource boxes. (Note that this representation may differ slightly in size and aspect ratio from the actual display of boxes in the view.)

Notice that Open Plan displays data items in the dialog box in order of line number. When you add, delete, or change data items, you must exit and return to the dialog box to display the items in the correct line sequence.

Open Plan displays items sharing the same line from left to right based on the order in which the items appear in the list. To move an item to a different position in the list, use the **Change Order** buttons.

You can customize the layout of the resource box with the following settings:

- **Field** — You can select any resource field for display.
- **Line** — For each field appearing in the resource box, you must assign a line number. Resource boxes can contain up to 20 lines, and each line can display one or more fields. If you assign multiple fields to a single line, the order in which the fields are listed in the dialog box determines how Open Plan displays the fields in the box. To display a blank line in the resource box, do not enter settings for those lines. For example, to display resource boxes with a double-high blank line, use the following settings:

Field	Line	Format
Res. ID	1	1 line
Res. Desc.	4	1 line

This results in the following resource box:

ENG
Engineers

- **Format** — This setting has the following options to control the display of the data in the box:
 - 1 Line
 - Wrap over 2 lines
 - Wrap over 4 lines
 - Wrap over 4 lines
- **Suppress Box Lines** — Selecting this option hides the display of lines within the resource boxes.

To customize the resource box layout

1. Take one of the following actions:
 - On the **Tools** menu, click **Preferences**.
 - Right-click an empty area within the workspace, and click **Preferences** on the menu.
2. On the Resource Display Preferences dialog box, click the Box Layout tab.
3. Enter the information for each data item.

To change the order of the items, select any cell in a row, and click one of the **Change Order** buttons.

To delete an item from the list, select any cell in the row, and press the **Delete** key.
4. When your changes are complete, click **OK** to return to the view.

Using the Zoom Out and Zoom In Commands

Open Plan provides a **Zoom Out** and **Zoom In** command for showing resource structures that cannot be displayed on a single screen.

If you select **Zoom Out** from the normal display mode, Open Plan applies a reduced display mode to the window. In this display mode, the resource boxes are reduced so that all the resources in the structure are visible:

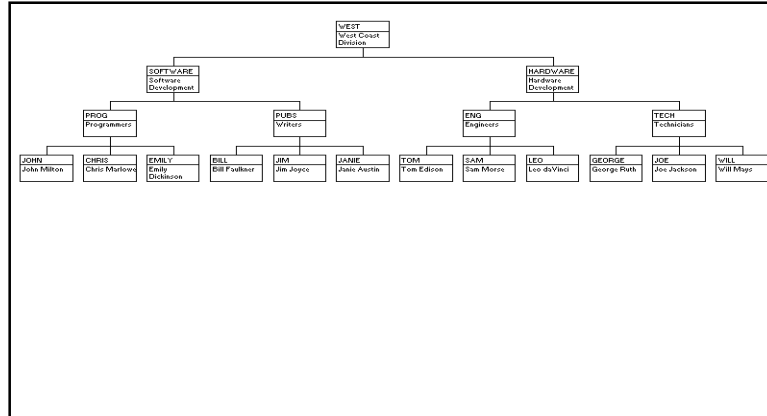

If the entire resource structure can be displayed at once, the **Zoom Out** command is not available.

In order to return to the normal display mode, Open Plan provides a **Zoom In** command. When the display mode has been reduced, the **Zoom In** command becomes enabled.

To zoom out from the normal display mode

1. Take one of the following actions:
 - On the **View** menu, click **Zoom Out**.
 - Right-click an empty area of the window, and click **Zoom Out** on the context menu.
 - On the toolbar, click the **Zoom Out** button .



Zoom Out button

To zoom in from a reduced display mode

1. Take one of the following actions:
 - On the **View** menu, click **Zoom In**.
 - Right-click an empty area of the window, and click **Zoom In** on the context menu.
 - On the toolbar, click the **Zoom In** button .



Zoom In button

Resources in Spreadsheet and Barchart Views

Open Plan includes three standard views in which you can update resource description information:

- Resource/Activity spreadsheets
- Multi-Table barcharts
- Single-table spreadsheets based on the Resource table

In each view, you can display the **Resource Details** dialog box by double-clicking the appropriate row in the view:

Double-click to display resource information.

Resource ID	Res. Desc.	Activity ID	Activity Desc.	Duration	Remaining Dur.	Early Start	Early Finish	Res. Cur
RES	Cleanup Resources			0	0			
RES.EQUIP	Equipment			0	0			
RES.EQUIP	Cleanup Equipment			0	0			
RES.EQUIP	Testing Equipment	1.09.02	Water Table Dr	26d	26d	26Oct04	20Nov04	
		1.02.01	Engineering Fi	13d	13d	19Mar03	04Apr03	
		1.03.06	Thermodynan	22d	22d	25Jul03	25Aug03	
		1.06.02	Laboratory Th	6d	6d	05Jun04	10Jun04	
RES.LAB	Labor			0	0			
RES.LAB.E	Engineers			0	0			
RES.LAB.C	Civil			0	0			
RES.L	Jim Armstrong			0	0			
		1.01.02	Site Managem	24d	24d	02Jan03	04Feb03	
		1.03.03	Spent Fuel Mo	50d	50d	02May03	10Jul03	
		1.05.02	Surface Test	8d	8d	11Mar04	22Mar04	
		1.10.02	Underground	24d	24d	07Jul04	09Aug04	
		1.12.02	Safety Analy	16d	16d	10Jan05	31Jan05	
		4.4.04	Equipments	24	24	04Feb05	02Feb05	

Multi-table barchart views allow you to display a time-scaled bar representing the assignments for a resource:

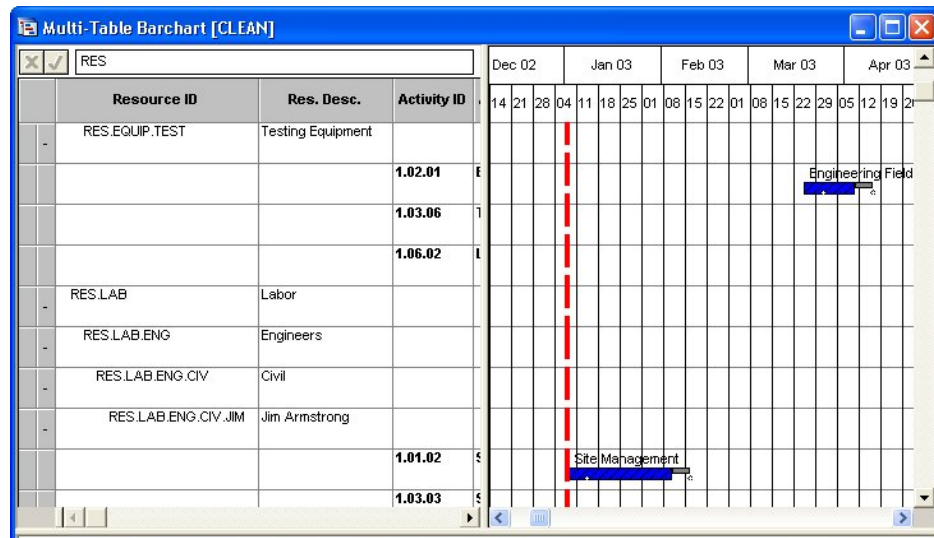



For information about displaying resource-related bars in a barchart view, refer to Chapter 6, “Customizing Barchart Views,” in the *Deltek Open Plan Developer’s Guide*.

To display resources in a single-table spreadsheet

1. Display a single-table spreadsheet view.
2. Take one of the following actions:
 - On the **Tools** menu, click **Preferences**.
 - Right-click an empty area of the **spreadsheet**, and click **Preferences** on the context menu.
3. From the **Table Name** list on the **Options** tab, select **Resource**.
4. Click **OK**.



For more information, refer to the “Support for All Tables” section of Chapter 20, “Spreadsheet Views.”

8

Resource Assignments

➤ Overview	205
➤ Entering Resource Assignments.....	206
➤ Resource Allocation	219
➤ Effort-Driven Activities.....	224
➤ Defining Assignment Profiles Manually.....	225

Overview

Resource assignments define which resources are required for the completion of one or more activities in a project. Open Plan provides a rich set of features for defining resource assignments. For example:

- You can describe assignments that apply for the entire duration of an activity or for only a portion of the duration.
- You can define assignments using profile curves that vary the amount of the resource required over the course of the assignment.
- You can define alternate resources that can be used in the absence of the requested resource.
- You can assign a resource pool or skill for an activity and have Open Plan select an available resource for you.

Resource assignments at the subproject level have no direct effect on the dates calculated by resource scheduling. However, these types of assignments may impact the availability of resources assigned to subsequent activities, thus resulting in delays



For more information about resource-related issues and subprojects, refer to Chapter 12, "Hierarchical Projects."

This chapter begins with a description of the different methods you can use to enter resource assignments. This is followed by a section on resource allocation — acting upon the resource assignments suggested by Open Plan. The chapter concludes with sections on effort-driven activities and defining assignment profiles manually.

Entering Resource Assignments

Open Plan provides two methods for entering resource assignments:

- The **Resources** tab of the **Activity Details** dialog box
- Spreadsheet views

Each of these methods is described in the following sections.

Using the Activity Details Dialog Box

To enter resource assignments using the **Activity Details** dialog box, display the dialog box, and click the **Resources** tab. Open Plan allows you to enter resource information in either of the following two modes: **Normal** and **Time Phase**.

Normal Mode

The default view is **Normal**:

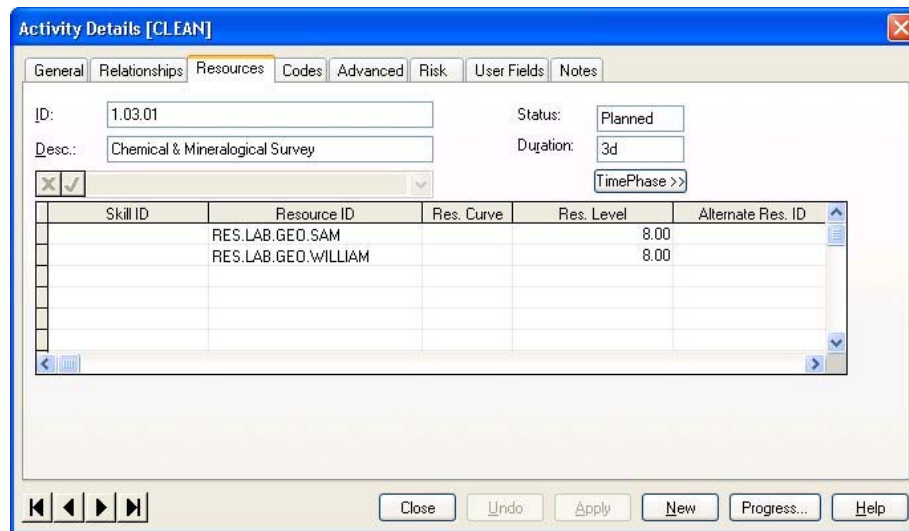

In **Normal** mode, Open Plan controls resource assignments for the selected activity. Each activity contains the following fields:

- **ID** — The identifier of the selected activity. An activity ID can contain 1 to 59 characters, including the periods that are used to indicate hierarchical levels.



IDs containing the following four symbols " , | ; are used as delimiters in Open Plan and should not be used in the ID field.

The activity ID serves as the default sort order for most views and reports.



Although Open Plan supports almost any activity numbering system, most organizations use activity IDs that have some significance built in such as a prefix that refers to the project. Another approach might be to use the activity ID to associate activities with specific elements in a work breakdown structure.

- **Desc** — The description of the selected activity



A description can contain up to 60 characters. You may use both upper- and lowercase characters.

In addition, this dialog box also features the following fields:

- **Status** — The status of an activity can be one of the following:
 - **Planned** — The activity has not yet started.
 - **In Progress** — The activity has started, but is not yet complete.
 - **Complete** — The activity is complete.
- **Duration** — Durations may use any of the following duration units:
 - **m** — months
 - **w** — weeks
 - **d** — days
 - **h** — hours
 - **t** — minutes

While duration may contain decimal values (for example, 4.5 D), you cannot enter duration using mixed duration units. (For example, 4D4H is not allowed.) Open plan interprets an activity with a blank duration field as having zero duration.



You can avoid having to specify a time unit when entering durations by assigning a default duration unit for a project through the Preferences tab on the Project Properties dialog box.



If the activity type is Subproject, Hammock, Effort Driven, or External Subproject, Open Plan ignores any value you enter in this field and recalculates the duration each time you perform time analysis.

The grid in this view contains the following columns:

- **Skill ID** — Once you have specified a skill in this column, when you add a resource on the same row using the **Select Resource** dialog box, the **Skill Filter** is preset to the intended skill, displaying only those resources that match the skill.
- **Resource ID** — You must select the resource ID for each resource assignment. This can be the ID for either a resource pool or an individual resource.

Clicking the **ellipsis** next to the list field displays the **Select Resource** dialog box that you can use to quickly select the appropriate resource.



For more information on the **Select Resource** dialog box, refer to the “Using the Select Resource Dialog Box” section later in this chapter.

- **Resource Curve** — In Open Plan, the amount of a resource requirement can be interpreted as either a total quantity or a level-per-time unit. For example, if a 5-day activity has a resource requirement of 10 units, this information can be

interpreted in two different ways: as a total requirement of 10 units or as a level of 10 units per day.

If you leave the **Resource Curve** setting blank, Open Plan interprets the amount of the resource requirement as a level-per-time unit. Thus, if the activity duration changes, the amount of the resource requirement changes as well.

If you want Open Plan to interpret the amount of the requirement as a total rather than as a level, change the **Curve** setting to one of the following values:

- B – Back Load
- D – Double Peak
- E – Early Peak
- F – Front Load
- L – Late Peak
- N – Bell (Normal)
- T – Linear



For a description of each profile curve, refer to Chapter 13, “Spread Curve Profiles,” in the *Deltek Open Plan Developer’s Guide*. For information on how to customize or create a spread curve, refer to Chapter 23, “System Utilities,” in this user’s guide.

For requirements defined as totals, the time unit for the requirement is based on the default duration unit specified for the project. For example, a total requirement for 10 people for a project scheduled in days is interpreted as a requirement for 10 labor-days.



For information on setting the default duration unit for a project, refer to Chapter 5, “File Properties.”

- **Resource Level** — The amount of the resource required. This numeric value is interpreted by Open Plan as either a level-per-activity time unit or as a total requirement, depending on the **Resource Curve** setting for the assignment.



For a discussion of how Open Plan interprets resource requirement levels and totals, refer to Chapter 10, “Resource Scheduling Calculations,” in the *Deltek Open Plan Developer’s Guide*. For a discussion of how Open Plan deals with resource profiles of in-progress activities, refer to Chapter 9, “The Effect of Progress Information,” in the *Deltek Open Plan Developer’s Guide*.

- **Alternate Resource ID** — You can enter an alternate for any required resource, pool, or skill. If Open Plan determines that the original required resource is not available during resource scheduling, it attempts to substitute the alternate resource. Following resource scheduling, you can use the resource allocation feature to confirm or change any substitutions Open Plan has suggested.
- **Resource Offset** — The assignment offset is a duration relative to the start of the activity when the resource is first required. For example, if you define the offset of an assignment as 5 days, the assignment will begin on the sixth day of the activity duration.

- **Resource Period** — The assignment period defines the duration for which the resource is required. If this parameter is left blank, the period duration defaults to the activity duration minus the offset duration.

For standard (that is, non-cost) resources, Open Plan does not allow you to enter values for an assignment offset and period that extend beyond the duration of the activity.



For more information about the differences between standard resources and cost resources, refer to Chapter 10, “Cost Information.”

- **Cost Class** — Cobra users can enter a cost class for each resource assignment in this column. This information is transferred to Cobra during cost/schedule integration.

Time Phase Mode

Click the **Normal** button to toggle to **Time Phase** mode:

The screenshot shows the 'Activity Details [CLEAN]' dialog box with the 'Resources' tab selected. The 'Normal' button is highlighted, indicating the current mode. The table below shows resource assignments for activity ID 1.03.01, 'Chemical & Mineralogical Survey'.

Skill ID	Resource ID	Cost Class	Total Qty	Apr 2003	May 2003
	RES.LAB.GEO.SAM		24.00	16.00	8.00
	RES.LAB.GEO.WILLIAM		24.00	16.00	8.00
Total Labor Qty:			48.00	32.00	16.00

In **Time Phase** mode, Open Plan allows resource assignments to be displayed and edited in a time-phase manner. This allows resource levels to be more precisely allocated within the duration of the activity.

When this mode is selected, any assignments displayed in the **Normal** mode are translated into time-phase periods starting at the activity early start date and spread based on the assignment’s spread curve, offset, period, and cost class.

Multiple assignments of the same resource with differing cost classes are treated as separate assignments when translated into time-phase periods.

The grid contains the following columns:

- **Skill ID** — Once you have specified a skill in this column, when you add a resource on the same row using the **Select Resource** dialog box, the **Skill Filter** is preset to the intended skill, displaying only those resources that match the skill.
- **Resource ID** — Open Plan uses the resources displayed in this column for the activity.



If you let your cursor hover over this field, Open Plan displays the description associated with the resource.

- **Cost Class** — Cobra users can enter a cost class for each resource assignment in this column. This information is transferred to Cobra during cost/schedule integration.
- **Total Qty** — The total amount of the resource requirement. If a resource assignment exists in **Normal** mode, the total quantity is calculated in one of the following ways:
 - **Level** — The Total Quantity is the Level of the resource assignment multiplied by the Duration. For example, if you assign a resource to work 8 hours per day on a 10 day activity, the resource requirement equates to 80 hours. Now, assume that the activity actually takes 12 days. Since the resource was assigned as a level per time unit, the resource will work on the activity for a total of 96 hours.
 - **Total** — The Total Quantity is the Level entered spread over the duration of the activity according to the assigned spread Curve. For example, if you assign a resource to work on the same 10 day activity for a total of 80 hours, you still have a fixed 80 hours of the resource to spread over the duration of the activity regardless of whether the activity duration is 10 or 12 days.
- **Cutoff Dates** — The time-phase cutoff dates are based on the project's fiscal calendar (if one has been assigned to the project). If there is no fiscal calendar, the cutoff dates are generated using weekly periods.
- **Total Labor Qty** — This summary row displays the total quantity for Labor resources for the **Total Qty** column and each time-phase cutoff date column.

The following additional options are available:

- **Show As Levels** — This option allows time-phase resource assignments values to be displayed and edited using a level-per-period value instead of a total-per-period value. When in this mode, the **Total Qty** column is disabled and used for reference only, and the **Spread** and **Reconcile** buttons are dimmed.
- **Spread** — This option displays the **Spread Method** dialog box that you can use to re-spread the total quantity over time-phase periods.

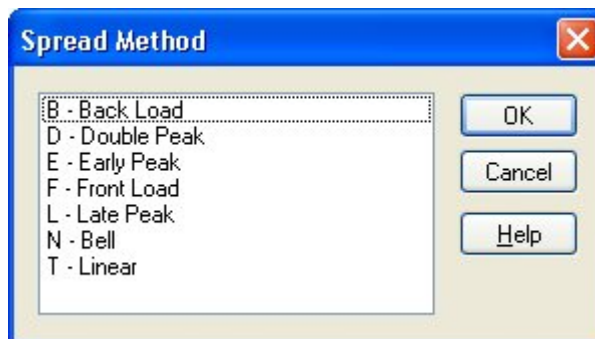

- **Reconcile** — If there is a discrepancy between the total quantity and the sum of the time-phase periods, you can use the **Reconcile** button to quickly fix the problem. When you click this button, the **Reconcile** command calculates the difference between the total quantity and the sum of the periods. The difference is placed into the selected period after you confirm the operation.

- **Show Time Phase Based On** — This option allows the direct updating of the integration baseline to apply a scope change, integrate the data with Cobra and analyze the Cost impact. You may select either **Current Plan (Early Dates)** or **Selected Baseline**. By default, **Current Plan (Early Dates)** is selected. You must click **Apply** to commit any changes you select.
- **Date Range** — The activity **Start** and **End** dates are displayed here.

To enter a resource assignment using the Activity Details dialog box

1. Select the activity for which you want to enter an assignment.
2. Take one of the following actions:
 - On the **Edit** menu, click **Assign Resource**.
 - Display the **Activity Details** dialog box, and click the **Resources** tab.
3. Enter the information for the assignment, and click **OK**.



If you assign a resource to an activity that already has one assigned to it, the new resource will be an addition to, not a replacement of, the existing resource.

Using the Assign Multiple Resources to Multiple Activities Dialog Box

It is possible to assign one or more resources to multiple activities using the **Assign Multiple Resources to Multiple Activities** dialog box:

Resource	Curve	Level	Offset	Period	Cost Class
RES.LAB.ENG.CIV.JIM		1.00	0	0	
RES.LAB.ENG.ELEC.LISA		1.00	0	0	

The fields on this dialog box are the same as those on the **Resources** tab of the **Activity Details** dialog box (discussed in the previous section) with the following additions:

- **From ID** — This field identifies the first activity in the activity hierarchy to which you are assigning resources.
- **To ID** — This field identifies the last activity in the activity hierarchy to which you are assigning resources.

The information in these fields does not imply that you are assigning resources to all the activities in the range. For example, if you have selected activities such as the following:

1.03.01

1.03.04

1.03.06

Open Plan would show 1.03.01 in the **From ID** field and 1.03.06 in the **To ID** field.

To assign one or more resources to multiple activities

1. Hold down **Shift** or **Ctrl**, and click the activities for which you want to assign a resource or resources.
2. On the **Edit** menu, click **Assign Resource**.
3. Open Plan automatically displays the **Select Resource** dialog box.
4. Select the resource(s) to assign to the activities, and click **OK**.
5. On the **Assign Multiple Resources to Multiple Activities** dialog box, enter the information for the resource(s), and click **OK**.

Using the Select Resource Dialog Box

The **Select Resource** dialog box is displayed when you click the **ellipsis** next to the list field when assigning a resource ID on the **Resources** tab of the **Activity Details** dialog box:

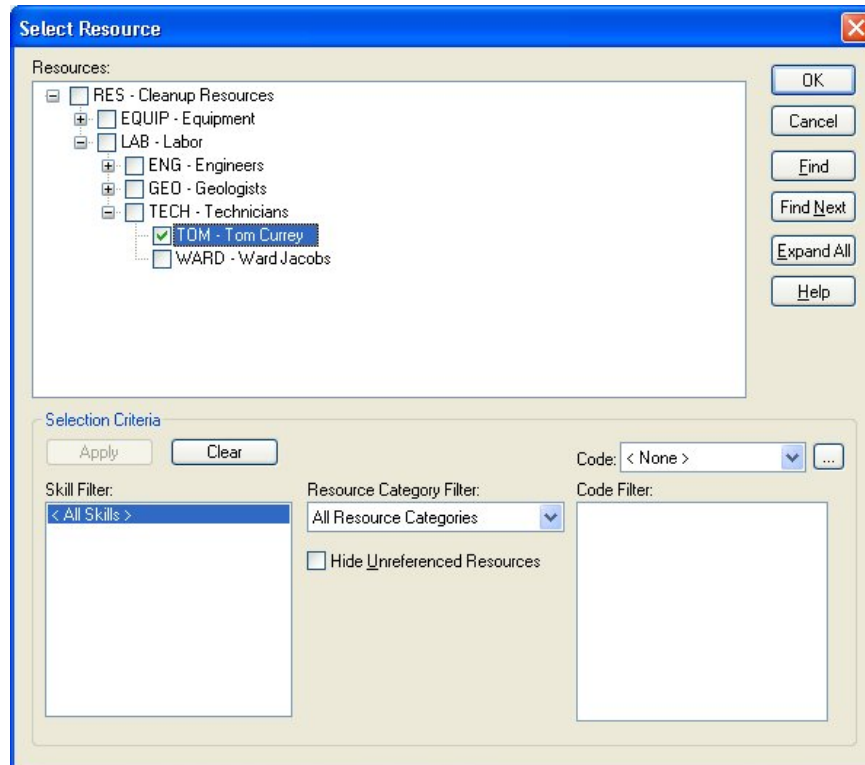

You can use the following controls on this dialog box when selecting a resource or resources to assign to an activity:

- **Resources** — This area displays a hierarchical representation of the resources in the currently assigned resource file. Different resources are displayed here as you apply or remove a skill filter.

Resources that have had skills assigned to them can display in this list followed by two numbers in parentheses. For example, a resource appearing as “Bob Johnson (10) (3)” indicates that Bob Johnson has an availability of 10 units (as defined on the **Preferences** tab of the **Project Properties** dialog box). It further indicates that this resource has a proficiency rating of “3”. Proficiencies are assigned to resources on the **Skills** tab of the **Resource Details** dialog box.

In general, resource availabilities that are reserved for another project are not displayed in this field. However, when an activity is part of an external subproject, Open Plan includes resources that have been reserved for the following elements of the hierarchical project:

- The subproject to which the activity belongs
- Any higher-level external subprojects
- The master project
- **Skill Filter** — This field contains a list of skills that you can use to filter the hierarchy of resources that is displayed:
 - **All Skills** — When selected, all resources are displayed in the Resources list and are available for selection on the activity. This is the default selection.
 - **Remaining entries in the list** — The remaining entries in the list are the skills that have been defined for resources in your company. When you click a skill in the list, the hierarchy in the list of available resources is updated to display only those resources possessing the selected skill.



If you select multiple skills by holding down the **Ctrl** or **Shift** key while making a selection, the hierarchy displays only those resources that possess all the selected skills.

- **Resource Category Filter** — This field contains a list of resource categories that you can use to filter the hierarchy of resources that is displayed:
 - **All Resource Categories** — If you select this value, Open Plan does not limit the display of resources to those with a specific resource category. All resource categories are displayed. This is the default selection.
 - **Labor** — If you select this value, Open Plan displays only labor resources in the hierarchy of resources.
 - **Material** — If you select this value, Open Plan displays only material resources in the hierarchy of resources.
 - **Other Direct Costs** — If you select this value, Open Plan displays only other direct cost resources in the hierarchy of resources.
 - **Subcontract** — If you select this value, Open Plan displays only subcontract resources in the hierarchy of resources.
 - **Skills** — If you select this value, Open Plan displays only subcontract skills in the hierarchy of resources.

- **Code** — If one or more code files have been assigned to the resource file, you can filter the display of available resources using a selected code. When you select a code file in this field, the Code Filter field is populated with the codes that you can use to filter the view.

Clicking the ellipsis button next to the Code selection list displays the Select Code dialog box:

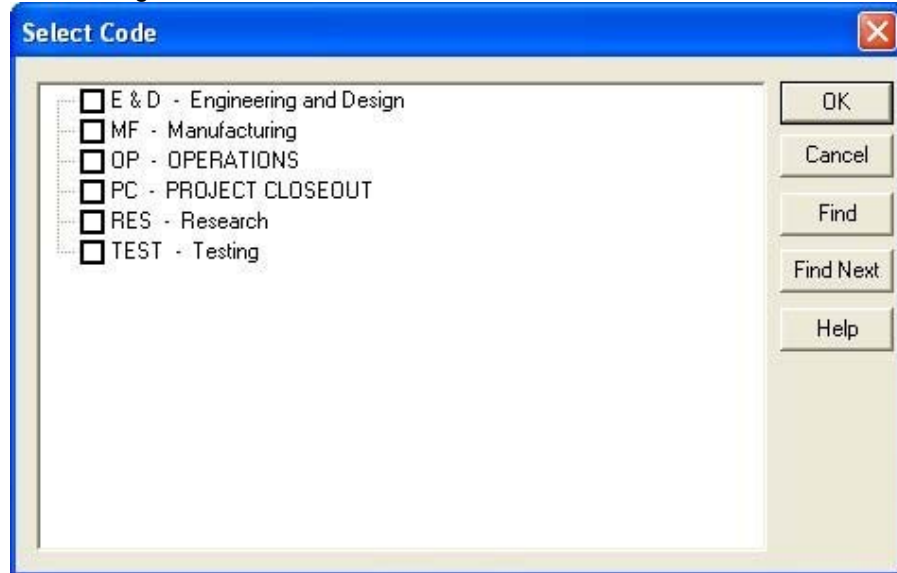

This dialog box allows you to filter the displayed codes in the Code Filter list. (This is useful if you are dealing with a very large, hierarchical code file.)

- **Code Filter** — When you select a code file from the **Code** field, the **Code Filter** list displays the codes available in the code file. Selecting a code from the list and clicking **Apply** filters the display of resources by that code.
- **Hide Unreferenced Resources** — This option allows you to hide resources that are not used in your project. This feature is useful if you always use the same group of resources for the project.
- **Display Only Available Resources** — When you select this option, Open Plan provides the following information about available resources that meet the selection filters:
 - Resources that are 100% available for the specified date range are listed with no additional information.
 - Resources that are available but who have less than 100% availability are listed with the minimum and maximum availability during the required period.

If no resources are available to meet the resource requirements of the activity, Open Plan displays the earliest date on which each resource meeting the selection filters is available.



When determining a resource's availability, Open Plan considers not only the current project, but also any other higher priority projects that share the same resource pool and for which Open Plan saves summary resource information.

Open Plan also displays the **Early Start** and **Early Finish** dates of the activity. This information is useful in the event that no suitable resource is available during the specified date range.

For example, assume that the early dates for the activity are as follows:

- Early Start — 02Feb02
- Early Finish — 15Feb02

Assume, too, that a resource with the required skills is not available until February 23. Under these circumstances, you might want to change either the skills required for the activity or the logic of the project so that the early start date for the activity coincides with the dates when the resource is available.

Once you have chosen the filter(s) to use for the resource display, click **Apply** to put them into effect. Clicking **Clear** removes all the filter choices you made.

The following buttons are located along the right-hand side of the dialog box:

- **OK** — Clicking this button assigns the selected resource to the activity.
- **Cancel** — Clicking this button closes the dialog box without assigning any resources.
- **Find** — Clicking this button displays the **Find** dialog box that you can use to find a resource with a specified ID, description, or skill.
- **Find Next** — Once you have located a resource using **Find**, clicking **Find Next** locates the next resource that meets the same search criteria.
- **Expand All** — Clicking this button fully expands the hierarchy of resources.



You can selectively expand portions of the hierarchy by clicking the appropriate **plus sign (+)** icon.

- **Select All** — Clicking this button selects all the resources in the hierarchy of resources regardless of whether the hierarchy is expanded.
- **Clear All** — Clicking this button clears the selections for all the resources in the hierarchy of resources regardless of whether the hierarchy is expanded.
- **Help** — Clicking this button displays the **Help** topic for this dialog box.

Using Spreadsheet Views

Open Plan allows you to display and, in some cases, update resource assignment information in a spreadsheet view. These views include:

- Single-table spreadsheet based on the Resource Assignment table
- Activity/resource spreadsheet
- Resource/activity spreadsheet

In a single-table spreadsheet view based on the Resource Assignment table, the resource assignment information appears in a tabular format, with each assignment displayed in a single row:

Activity ID	Resource ID	Res. Curve	Res. Level	Remaining Requirement	Res. Offset	Res. Period
1.01.01	RES.LAB.ENG.MECH.IKE		2.00	60.00	0	0
1.01.02	RES.LAB.ENG.CIV.JIM		2.00	48.00	0	0
1.02.01	RES.LAB.ENG.MECH.CHRIS		5.00	65.00	0	0
1.02.01	RES.LAB.ENG.CIV.SUE		8.00	104.00	0	0
1.02.01	RES.EQUIP.TEST		8.00	104.00	0	0
1.02.01	RES.LAB.ENG.CIV.MIKE		8.00	104.00	0	0
1.02.02	RES.LAB.ENG.ELEC.PAUL		10.00	160.00	0	0
1.03.01	RES.LAB.GEO.WILLIAM		8.00	24.00	0	0
1.03.01	RES.LAB.GEO.SAM		8.00	24.00	0	0
1.03.02	RES.LAB.GEO.WILLIAM		8.00	400.00	0	0
1.03.03	RES.LAB.ENG.CIV.JIM		8.00	400.00	0	0
1.03.04	RES.LAB.ENG.MECH.KELLEY		2.00	76.00	0	0
1.03.05	RES.LAB.TECH.TOM		10.00	100.00	0	0
1.03.05	RES.LAB.TECH.VWARD		10.00	100.00	0	0
1.03.06	RES.LAB.ENG.MECH.IKE		8.00	176.00	0	0
1.03.06	RES.EQUIP.TEST		8.00	176.00	0	0
1.03.07	RES.LAB.ENG.MECH.KELLEY		6.00	276.00	0	0
1.04.01	RES.LAB.ENG.MECH.CHRIS		8.00	460.00	0	0

In this type of view, you can add assignments in one of two ways. If the activity already has at least one assignment, you can edit the **Resources** tab of the **Activity Details** dialog box. You can also insert a new row in the spreadsheet and specify both the activity and the assigned resource.

Activity/resource spreadsheets display multiple assignments for each activity using an outlining format:

Activity ID	Duration	Resource ID	Res. Desc.	Units	Unit Cost	Curve	Level	Remaining	Offset	Period	Available	Ava
1	572d				0.00		0.00	0.00	0	0	0.00	
1.01	54d				0.00		0.00	0.00	0	0	0.00	
1.01.01	30d				0.00		0.00	0.00	0	0	0.00	
1.01.01		RES.LAB.ENG	Ike Hamlin	labor	46.00		2.00	60.00	0	0	8.00	02Ja
1.01.02	24d				0.00		0.00	0.00	0	0	0.00	
1.01.02		PROJECT.MAT			1.00		500.00	12000.00	0	0	0.00	
1.01.02		RES.LAB.ENG	Jim Armets	labor	50.00		2.00	48.00	0	0	8.00	02Ja
1.02	29d				0.00		0.00	0.00	0	0	0.00	
1.02.01	13d				0.00		0.00	0.00	0	0	0.00	
1.02.01		RES.EQUIP.TE	Testing Eq	Equip	200.00		8.00	104.00	0	0	8.00	02Ja
1.02.01		RES.LAB.ENG	Mike Holm	labor	46.00		8.00	104.00	0	0	8.00	02Ja
1.02.01		RES.LAB.ENG	Sue Johns	labor	55.00		8.00	104.00	0	0	8.00	02Ja
1.02.01		RES.LAB.ENG	Chris Newr	labor	60.00		5.00	65.00	0	0	8.00	16Ja
1.02.02	16d				0.00		0.00	0.00	0	0	0.00	
1.02.02		RES.LAB.ENG	Paul Robert	labor	50.00		10.00	160.00	0	0	10.00	02Ja

Click to expand or collapse the assignments for an activity

In an activity/resource spreadsheet view, Open Plan displays a **plus (+)** sign or a **minus (-)** sign on the outlining button to the left of the row to control the display of assignment information. If the outlining button displays a plus sign, you can expand the activity to see all of its assignments. If the outlining button displays a minus sign, the activity is already expanded, and clicking the outlining button will collapse the display of assignments. If the outlining button on an activity row is blank, the activity does not have any resource assignments.



For more information about expanding and collapsing items in a spreadsheet view, refer to Chapter 12, "Hierarchical Projects."

In this type of view, you can display the **Activity Details** dialog box for an activity and edit the **Resources** tab.

Resource/activity spreadsheets allow you to see multiple assignments for each resource:

Click to expand or collapse the assignments for a resource

Resource ID	Res. Desc.	Activity ID	Activity Desc.	Duration	Remaining Dur.	Early Start	Early Finish	Re
RES	Cleanup Resources			0	0			
RES.EQUIP	Equipment			0	0			
RES.EQUIP.CLEAN	Cleanup Equipment			0	0			
		1.09.02	Water Table D	26d	26d	26Oct04	20Nov04	
RES.EQUIP.TEST	Testing Equipment			0	0			
		1.02.01	Engineering Fi	13d	13d	19Mar03	04Apr03	
		1.03.06	Thermodynan	22d	22d	25Jul03	25Aug03	
		1.06.02	Laboratory Th	6d	6d	05Jun04	10Jun04	
RES.LAB	Labor			0	0			
RES.LAB.ENG	Engineers			0	0			
RES.LAB.ENG.CIV	Civil			0	0			
RES.LAB.ENG.CIV	Jim Armstrong			0	0			
		1.01.02	Site Managem	24d	24d	02Jan03	04Feb03	
		1.03.03	Spent Fuel Mo	50d	50d	02May03	10Jul03	
		1.05.02	Surface Test	8d	8d	11Mar04	22Mar04	
		1.10.02	Underground	24d	24d	07Jul04	09Aug04	
		1.12.02	Safety Analy	16d	16d	10Jan05	31Jan05	
		1.14.01	Environmenta	3d	3d	01Feb05	03Feb05	

This type of view is used mainly for reporting purposes, but you can edit the **Resources** tab of the **Activity Details** dialog box for an activity.



The activity/resource spreadsheet view and the resource/activity spreadsheet view are found in the Open Plan Library Views folder. The names of the views are AVLSPDVW and RCSPDVW respectively.

To add an assignment to a single-table spreadsheet based on the Resource Assignment table

1. Display the Resource Assignment table in a single-table spreadsheet view.
2. On a blank row, select the **Activity ID** cell.
3. Click the **ellipsis** button to the right of the edit box at the top of the spreadsheet.

Open Plan displays the **Choose a Value** dialog box that lists the available activities.

4. Select the activity from the list, and click **OK**.
5. Select the **Res. ID** cell for the row, and repeat steps 2 and 3.
6. Enter the rest of the information for the assignment.



For information on how to display resource assignments in a single-table spreadsheet, refer to the "Support for All Tables" section of Chapter 20, "Spreadsheet Views."

To add an assignment using the Activity Details dialog box

1. In a spreadsheet view, double-click the selection button to the left of the activity to which you want to add an assignment.
2. On the **Activity Details** dialog box, click the **Resources** tab.
3. Enter the information for the assignment.
4. When done, click **Apply**, then **Close**.

Using Barchart Views

In addition to spreadsheet views, Open Plan includes two standard barchart views for displaying resource assignment information — activity/resource barcharts and resource/activity barcharts.

In an activity/resource barchart, resource assignments can appear as bars beneath an activity bar:

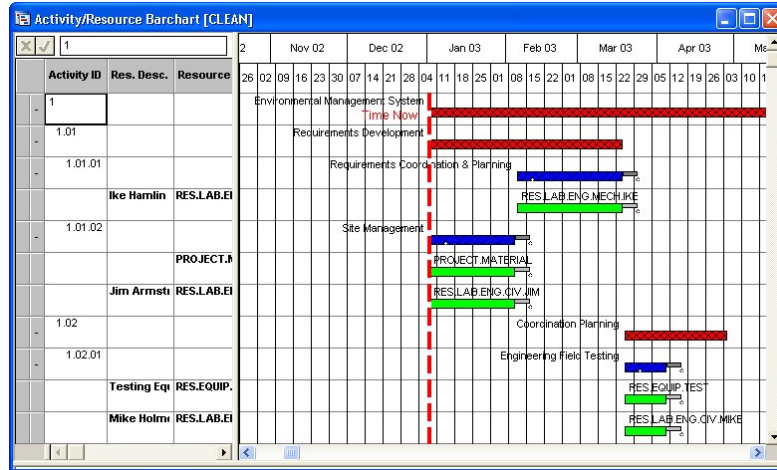

In a resource/activity barchart, you can display all of the assignments for a specific resource:

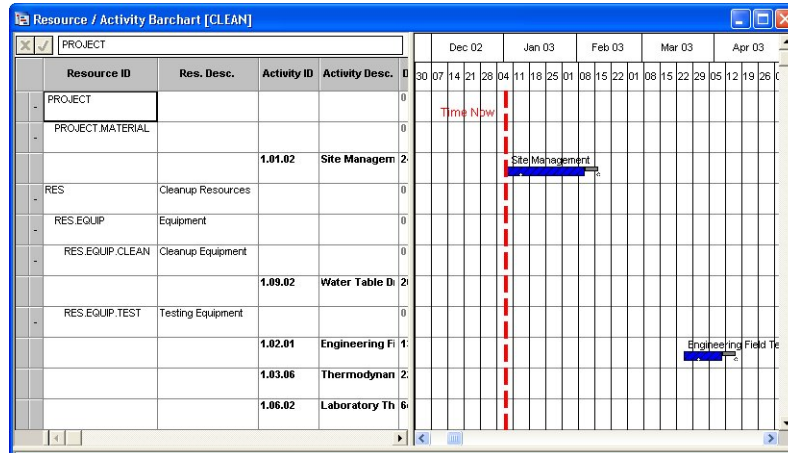

Both of these types of views are designed primarily for reporting purposes and have limited data input features.

Resource Allocation

During resource scheduling, Open Plan suggests a resource for each resource assignment. If you defined the assignment using an alternate resource, this suggested resource may be the requested resource, or it may be the alternate resource you specified. It is also possible that you assigned either a pool or a skill to the activity. In that case, Open Plan suggests an individual resource that fulfills the requirement.

After performing resource scheduling, you have the opportunity to review these suggested resources and take an appropriate action. In Open Plan, this process is referred to as “resource allocation,” and the results of this process appear in the **Activity Resource Allocation** dialog box:

Resource requested by planner

Skill ID	Requested	Level	Alternate	Suggested
	RES.LAB.ENG.CIV.MIKE	104.00		RES.LAB.ENG.CIV.MIKE
	RES.LAB.ENG.CIV.SUE	104.00		RES.LAB.ENG.CIV.SUE
	RES.EQUIP.TEST	104.00		RES.EQUIP.TEST
	RES.LAB.ENG.MECH.CH	65.00		RES.LAB.ENG.MECH.CH

Resource suggested by Open Plan

This dialog box is modeless; in other words, you can leave the dialog box open when performing other operations. Four navigation arrows in the lower-right corner of the dialog box allow you to scroll through the records in the file.



For more information on modeless dialog boxes, refer to Chapter 2, “Basic Skills.”

If Open Plan suggested the requested specific resource, you do not need to take any action. However, if Open Plan suggests an alternate resource, a resource from a pool, or a resource with a specified skill, you need to decide whether you want to act on the suggestion at this time.

There are two different actions you can take during a resource allocation session:

- You can replace the requested resource with the one suggested by Open Plan.
- You can lock the requested resource, which has the effect of removing the alternative resource from future consideration for the assignment.

These actions take effect the next time you perform resource scheduling on the project.

Your role in resource allocation is to review the resources Open Plan suggests for each activity. You can either accept the suggestion by replacing the requested resource with the suggested resource or ignore the suggestion for the time being.

In general, you should use the following steps when calculating a schedule using pools, skills, or alternate resources:

- **Step 1** — After making your initial resource assignments and conducting a time analysis of the project, perform resource scheduling.
- **Step 2** — Use the **Activity Resource Allocation** dialog box to review the suggested resources for each activity and make any necessary changes.



You cannot display this dialog box for activities without resource assignments.

- **Step 3** — Perform resource scheduling again.
- **Step 4** — To see the effect of your choices in resource allocation on the schedule and resource utilization, display a histogram view showing the resources you are most interested in.

Typically, you would repeat this procedure several times until you are satisfied with the resource assignment for each activity.

To display the Activity Resource Allocation dialog box

1. Take one of the following actions:
 - Select the activity for which you want to review the resource allocations, and click **Allocation** on the **Edit** menu.
 - Right-click the activity, and click **Allocation** on the context menu.

Replacing Requested Resources for an Activity

During resource scheduling, if Open Plan suggests that you use the alternate resource for an activity, you have the option of acting on the suggestion. This instructs Open Plan to replace the assignment for your requested resource with the alternate suggested by Open Plan.

For example, assume that you have specified RES.LAB.ENG.MECH.IKE for an activity, but will accept RES.LAB.ENG.MECH.KELLEY as an alternate if the requested resource is not available. As the result of resource scheduling, Open Plan suggests that RES.LAB.ENG.MECH.KELLEY be used.

In the **Activity Resource Allocation** dialog box, Open Plan identifies the requested, alternate, and suggested resources:

Requested	Level	Alternate	Suggested	Used
RES.LAB.ENG.MECH.IKE	60.00	RES.LAB.ENG.MECH.KELLEY	RES.LAB.ENG.MECH.IKE	60.00

If you choose to accept the suggestion, Open Plan makes the alternate resource the requested one:

Activity Resource Allocation

ID: 1.01.01
 Desc: Requirements Coordination & Planning

Total Float: 4d Original Duration: 30d Earliest Feasible Start: 05Feb03
 Free Float: 0 Scheduled Duration: 30d

Delaying Resource:

Requested	Level	Alternate	Suggested	Used
RES.LAB.ENG.MECH.KELLEY	60.00	RES.LAB.ENG.MECH.IKE	RES.LAB.ENG.MECH.KELLEY	60.00

Buttons: OK, Cancel, Accept, Lock, Help

Note, however, that this action may not have a permanent effect. Unless you lock the resource requirement (discussed later in this chapter), Open Plan may suggest either your requested resource or an alternate resource the next time you run resource scheduling. Therefore, it is possible for you to replace the requested resource with the suggested resource during one resource scheduling session and have Open Plan suggest your originally requested resource during a subsequent resource scheduling session.



Once you have replaced the originally requested resource, future resource scheduling sessions may not allow you to undo the replacement. In the above example, for instance, restrictions on the availability of RES.LAB.ENG.MECH.IKE may result in Open Plan never suggesting that resource as an alternative to RES.LAB.ENG.MECH.KELLEY. You can, of course, always restore the original assignment by re-entering the information for the assignment in the **Activity Details** dialog box. However, to maintain flexibility in your resource assignments for as long as possible, consider replacing requested resources only for activities planned in the near future.

To replace a requested resource with a suggested resource

- Take one of the following actions:
 - Select the activity for which you want to replace resources, and click **Allocation** on the **Edit** menu.
 - Right-click the activity, and click **Allocation** on the context menu.
- In the **Activity Resource Allocation** dialog box, select the assignment, and click **Accept**.
- To return to the view, click **OK**.

Using Resource Locking

The objective of resource locking is to inhibit future alternate resource scheduling. If you lock a selection, you are telling Open Plan that you do not want to consider

any other resource for the specified activity. You may want to lock a resource selection in any number of situations. For example:

- As Time Now approaches the date on which an activity is scheduled to start, you should consider locking resources for that activity.
- It may be important that you use the same resource for a series of activities.
- You may feel particularly comfortable using the suggested resource for the activity.

For example, assume that Open Plan suggests that RES.LAB.ENG.MECH.IKE be used for an activity, and you do not want to consider any other resource for the activity:

Activity Resource Allocation

ID: 1.01.01
 Desc: Requirements Coordination & Planning

Total Float: 4d Original Duration: 30d Earliest Feasible Start: 05Feb03
 Free Float: 0 Scheduled Duration: 30d

Delaying Resource:

Requested	Level	Alternate	Suggested	Used
RES.LAB.ENG.MECH.IKE	60.00	RES.LAB.ENG.MECH.KELLEY	RES.LAB.ENG.MECH.IKE	60.00

Buttons: OK, Cancel, Accept, Lock, Help

When you lock the resource for the activity, Open Plan deletes the alternate resource specification and makes the requested resource the required resource. (On the following screen, note that the **Alternate** field is now blank.)

Activity Resource Allocation

ID: 1.01.01
 Desc: Requirements Coordination & Planning

Total Float: 4d Original Duration: 30d Earliest Feasible Start: 05Feb03
 Free Float: 0 Scheduled Duration: 30d

Delaying Resource:

Requested	Level	Alternate	Suggested	Used
RES.LAB.ENG.MECH.IKE	60.00		RES.LAB.ENG.MECH.IKE	60.00

Buttons: OK, Cancel, Accept, Lock, Help



You can lock a resource assignment regardless of whether Open Plan suggests your requested resource or an alternate resource.

Once you have locked a resource for an activity, the only way to re-assign an alternate resource requirement is to return to the **Activity Details** dialog box. For this reason, consider locking resources only for activities planned in the near future.

To lock a requested resource

1. Take one of the following actions:
 - Select the activity for which you want to lock resources, and click **Allocation** on the **Edit** menu.
 - Right-click the activity, and click **Allocation** on the context menu.
2. In the **Activity Resource Allocation** dialog box, select the assignment, and click **Lock**.
3. To return to the view, click **OK**.

Effort-Driven Activities

With effort-driven activities, you can have Open Plan calculate the activity duration based on resource assignments. Typically, you might enter resource assignments at an early stage of the planning process and then use this feature to generate durations for activities automatically.

To calculate an effort-driven duration, Open Plan determines the longest span implied by any assignment for the activity by dividing the amount of the assignment by the resource effort factor. (Notice that the availability or non-availability of the resource does not affect the results of this calculation.) The result of the calculation is expressed in the default duration units used by the project.

For example, assume that the activity has a single resource assignment based on the following information:

- Resource assignment level for the activity — 10 units
- Resource effort factor — 0.5
- Default duration unit for project — days

Open Plan would calculate the effort-driven duration as 20 days (10/0.5).

To perform this calculation, Open Plan interprets any assignment level as a total requirement and ignores any assignment offsets and periods.

Defining an activity as effort-driven also affects the behavior of the activity during subsequent resource scheduling sessions as follows:

- The activity is assigned the reprofilable attribute. (You can override this setting if you wish.)
- Resource assignments defined as levels are treated as totals using a linear spread curve.
- Assignment offsets and periods are ignored.



To change an effort-driven activity back to one with a fixed duration, you can change the activity type to **ASAP**, or you can simply overwrite the calculated duration manually. If you enter a fixed duration but keep the activity type set to **Effort Driven**, Open Plan automatically recalculates the duration the next time you enter or change resource assignment information.

To define an activity as effort-driven

1. Click the **General** tab of the **Activity Details** dialog box for the activity.
2. Select **Effort Driven** for the activity **Type**, and click **OK**.
3. When Open Plan asks you to confirm the selection, click **OK**.

Defining Assignment Profiles Manually

Although it is possible to define a simple profile for each assignment using one of the standard curves, the use of assignment offsets and periods, combined with the ability to specify more than one assignment for the same resource, allows you to define much more complex resource profiles for an activity.

Using offsets and periods, for example, you can construct the following profile by defining 3 resource assignments for an activity with duration of 5 days:

Resource	Curve	Level	Offset	Period
TUBING	(blank)	50	0 (or blank)	5d (or blank)
TUBING	(blank)	25	2d	3d
TUBING	(blank)	100	3d	1d

This would result in the following resource profile:

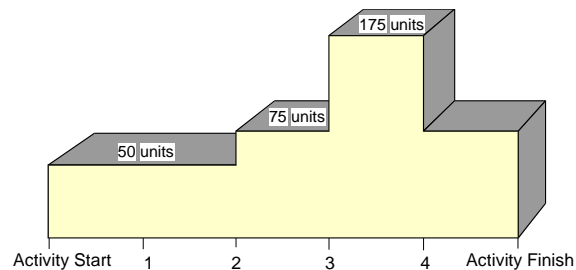

A potential disadvantage of this approach, however, is that subsequent changes in the planned duration of an activity may have unintended consequences for the definition of offsets and periods.

In cases where activity progress has been recorded and an activity is partially complete, Open Plan takes the offset duration relative to the original activity duration when calculating resource usage but bases this calculation on the end of an activity duration rather than its beginning.



For more information about the effect of progress information on resource scheduling, refer to Chapter 9, "The Effect of Progress Information," in the *Deltek Open Plan Developer's Guide*.

9

Project Calendars

➤ Overview	229
➤ Calendar Files	230
➤ Calendars	232

Overview

By defining the days and hours during which work can be scheduled, calendars allow you to create a realistic project plan. Typically, calendars are standardized across an entire organization and define a standard working day (for example, 8:00 A.M. to 4:00 P.M.), a normal workweek (for example, Monday through Friday), and a set of observed holidays. In some cases, you may want to define more detailed calendars that contain information such as a specific activity work schedule or an employee vacation schedule.

Open Plan has a flexible calendar function that allows you either to define calendar files on a project-by-project basis or to create a single calendar file that can be used with multiple projects. Calendars can also be defined for resource files. Within each calendar file you can define a default calendar, which can then serve as the model for subsequent calendars. You can also define a standard workweek for a calendar and then define any holidays or extra days as exceptions.

These features can help you create and maintain project and resource calendars that can be used for planning purposes throughout your organization.

Calendar Files

Open Plan stores information about working and non-working times in calendar files. Each time you perform a scheduling operation that calculates dates (for example, time analysis), Open Plan refers to the calendar file assigned to the project. In this way, work is scheduled to take place only during valid working times.



User-defined dates such as target dates or actual dates are not restricted to valid working days.

Because activities and resources within the same project can have different work schedules, calendar files can include multiple calendars, each defining a specific set of working and non-working times. Think of a calendar file as a container storing all the possible calendars that activities, resources, and relationships in a project might use. For example, a single calendar file might contain calendars that define different shift patterns, workweeks, or sets of holidays. This design allows the same project to use different definitions of working hours, working days, and holidays. There are no limits to the number of calendars you can define in a single calendar file.

In the Open Plan Explorer, calendar files are stored in the **Calendar** folder of the **Open Plan Library**.

You can open calendar files from within either the **Open Plan Library** or a specific project or resource folder. You can assign a calendar file to projects and resource files using either of the following methods:

- By using the **Files** tab of the appropriate **Properties** dialog box.
- By dragging the calendar file from the **Open Plan Library** to the project or resource folder.

Calendar files can be project-specific, or they can be shared by multiple projects. If you make changes to the information in a calendar file, the changes will affect all of the projects to which the calendar file is assigned. To make changes in a calendar file to affect only a single project, make sure that the calendar file is not assigned to other projects.



If you do not assign a calendar file to a project, Open Plan assumes that work can be scheduled using a 40-hour workweek (8 hours per day, 5 days per week, and no holidays).

To create a calendar file

1. Take one of the following actions:
 - On the **File** menu, click **New**.
 - Press **Ctrl+N**.
 - On the toolbar, click the **New** button.
 - Double-click an empty area of the Open Plan Explorer.
2. From the list of file types, select **Calendar**.
3. Enter the information for the new calendar file.

 New button

4. Take one of the following actions:
 - To start the **New File Wizard** where you can define the settings for the calendar file, click **Next**.
 - To create the calendar file using default settings, click **Finish**.

Open Plan creates a new calendar file and displays the default calendar.



For more information on using the **New File Wizard**, refer to Chapter 4, “Creating a New File.”

To open a calendar file

1. Take one of the following actions:
 - Double-click the calendar file.
 - Right-click the calendar file, point to **Open** on the context menu, and select the mode in which to open the file from the submenu.
 - On the toolbar, click the **Open** button to display the **File Open** dialog box.



Open button

To copy a calendar file

1. Open the calendar file.
2. On the **File** menu, click **Save As**.
3. Enter the name for the copy of the file, and click **OK**.



You cannot perform **Save As** on a file if there is another file open which refers to it. For example, if you open project CLEAN and then try to perform a **Save As** on the calendar file CLEANCAL, the **Save As** command is disabled.

To delete a calendar file

1. Take one of the following actions:
 - Select the calendar file, and press the **Delete** key.
 - Right-click the calendar file, point to **Manage Files**, and click **Delete File** on the context menu to display the **Select File to Delete** dialog box.
2. When Open Plan asks you to confirm the deletion, click **Yes**.



Deleting a calendar file from a project folder removes any activity calendar assignments from the project.

To assign a calendar file to a project or resource

1. Take one of the following actions:
 - Drag the calendar file from the **Open Plan Library** to the project or resource folder.
 - On the **Files** tab of the **Project Properties** dialog box, specify the name of the calendar file.

Calendars

Open Plan calendar files consist of one or more calendars, each defining a specific set of working and non-working times. Each day can have one of four possible definitions:

- **Working day** — A work day as defined by the standard workweek
- **Non-working day** — A non-work day as defined by the standard workweek
- **Holiday** — A standard working day that has been designated as non-working
- **Extra work day** — Either a non-working day that has been designated as working or a working day with non-standard hours

For each working or extra work day, it is possible to define up to 10 spans of valid working times. For example, to describe your standard office hours as 8:00 A.M. to 4:30 P.M. with a 30-minute lunch break, you could define two working periods: 8:00 A.M. to 12:00 P.M., and 12:30 P.M. to 4:30 P.M..

How you set up your calendars for a particular calendar file largely depends on your scheduling requirements. In some cases, you may want to set up a simple calendar file containing only a handful of calendars: one calendar for activities that must be performed Monday through Friday and another calendar for activities that can be scheduled over weekends. In other cases, you may need to set up individual calendars for each resource. This approach allows resource scheduling calculations to take into account such varied factors as part-time status, availability for overtime, and personal vacation schedules.

The Default Calendar

Each time you create a new calendar file, Open Plan automatically creates a default calendar that defines a Monday-through-Friday workweek with no holidays. Each work day has 8 working hours — 8:00 A.M. to 4:00 P.M.. This default calendar serves as the model for all new calendars added to the file.

In addition to using the default calendar as a model for subsequent calendars, Open Plan applies the default calendar to all activities and to resources that have not been assigned specific calendars.

You can modify the contents of a default calendar at any time. Although changing a default calendar has no effect on existing calendars in the file, any calendars you add thereafter will be based on the new defaults. Thus, you can customize a default calendar using the most commonly used work calendar (which might include, for example, a list of standard corporate holidays) and then set up subsequent calendars on an exception basis.



If all of the activities and resources in a project use the same calendar, you can, in effect, define a project calendar by customizing the default calendar of the calendar file assigned to the project.

Activity and Relationship Calendars

You can specify both a default activity calendar and a default relationship calendar on the **Preferences** tab of the **Project Properties** dialog box:

The screenshot shows the 'Project Properties' dialog box with the 'Preferences' tab selected. The 'Def. Activity Calendar' is set to '< Default >' and the 'Def. Relationship Calendar' is set to '< Calendar of Successor >'. The 'Default Date Format' is '31Dec01' and the 'Default Activity Type' is 'ASAP'. The 'Startup View' is 'BARVW - Activity Barchart View'. The 'Default Res. Curve' and 'Default Res. Level' are set to '< First Availability >'. The 'Conversions' section shows 'per Day: 8 hrs 0 mins', 'per Week: 40 hrs 0 mins', and 'per Month: 160 hrs 0 mins'. The 'Durations' section shows 'Default Units: Days' and 'Min Calculated Duration: Days'. The 'Default Access Mode' section shows 'Project: Exclusive' and 'Auxiliary Files: Exclusive'. The 'Earned Value' section shows 'EVT: Percent Complete' and 'Start %: 0'. Buttons for 'OK', 'Cancel', and 'Help' are at the bottom right.

The **Def. Activity Calendar** field is used to specify that an existing calendar is to be used as the default calendar for new activities.

The **Def. Relationship Calendar** field is used to specify that an existing calendar is to be used as the default calendar for new relationships.

To display the Preferences tab of the Project properties dialog box

1. Take one of the following actions:
 - Select the project, and click **Properties** on the **Project** menu.
 - Right-click the project folder, and click **Properties** on the context menu.
2. Click the **Preferences** tab.

Resource Calendars

You can assign a calendar file to a resource file either by dragging it from the Open Plan Library to the resource folder or by using the **Files** tab of the resource file's **Properties** dialog box:

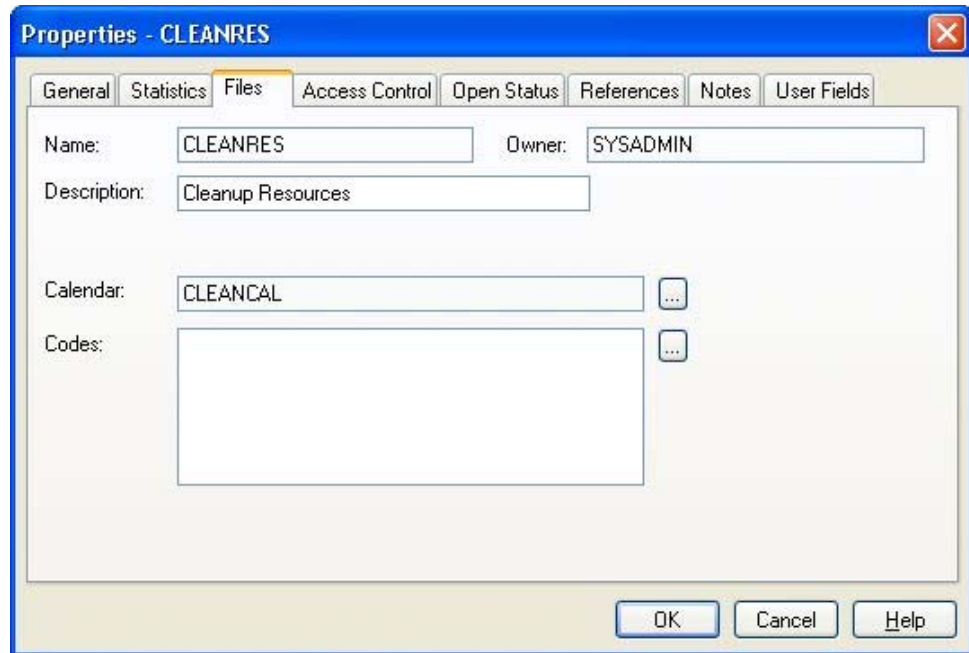

Clicking the **ellipsis** button to the right of the **Calendar** field displays the **Select** dialog box from which you can select the appropriate calendar file.

The calendar file you assign to the resource file helps to define the availability of resources. Since the calendars you assign to resources are defined in the resource calendar file, resource availabilities are consistent when viewed by different projects.



For information on resource availabilities, refer to Chapter 7, “Resource Definitions.”
For information on creating codes, refer to the “New File Wizard — Files Page” section of Chapter 4, Creating a New File.”

To assign a calendar file to a resource file using the Properties dialog box

1. Right-click the resource folder, and click **Properties** on the context menu.
2. Click the **Files** tab.
3. Click the **ellipsis** button at the right edge of the **Calendar** field.
4. From the **Select** dialog box, select the calendar file to assign to the resource file.
5. Click **OK**.

To assign a calendar file to a resource file using drag and drop

1. Locate the appropriate calendar file in the Open Plan Library.
2. Drag it to the target resource file folder.



Be sure to drag the calendar file to the resource file folder and **not** to the project folder. Dragging it to the project folder will replace the project calendar.

Adding Calendars

If you want to define more patterns of work than can be described using the default calendar, you can add additional calendars to a calendar file. Any new calendar you add inherits all of the information stored for the default calendar.

When adding a new calendar as a child, the child calendar inherits its settings from the parent. For example, a parent calendar can be defined to show company and public holidays while child calendars can be defined to show additional personal holidays for individual employees. Using this feature, the individual employee calendars will also include both the company and public holidays that have been defined in the parent calendar.

There is no limit to the number of calendars that you can define for a single calendar file.

To add a calendar to a calendar file, use the **Manage Calendars** command to display the following dialog box:

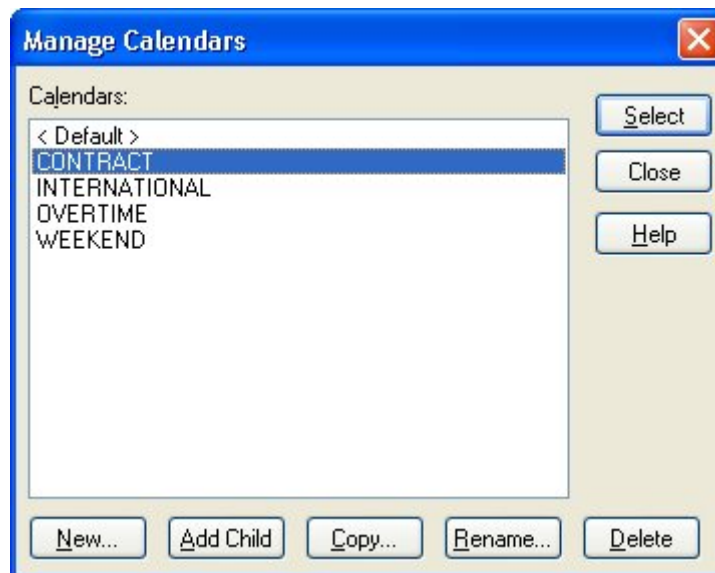

To add a calendar

1. Open the appropriate calendar file.
2. Take one of the following actions:
 - On the **Edit** menu, click **Manage Calendars**.
 - Right-click the calendar display, and click **Manage Calendars** on the context menu.
3. On the **Manage Calendars** dialog box, click **New**.
4. Enter the name for the new calendar, and click **OK**.
5. Open Plan creates the new calendar based on the default calendar in that calendar file.
6. To display the new calendar, select the calendar, and click **Select**.

To display different calendars in a calendar file

1. Open the appropriate calendar file.

2. Take one of the following actions:
 - On the **Edit** menu, click **Manage Calendars**.
 - Right-click the calendar display, and click **Manage Calendars** on the context menu.
3. In the **Manage Calendars** dialog box, select the calendar you want to display, and click **Select**.

Defining a Standard Workweek

For each calendar in a calendar file, you can define a standard workweek, that is, the normal working hours and days for the calendar. Typically, you would want to do this immediately after creating a new calendar.

Once you have defined a standard workweek for a calendar, you need specify only those working times or days that deviate from the standard.

Use the following dialog box to define the standard workweek for a calendar:

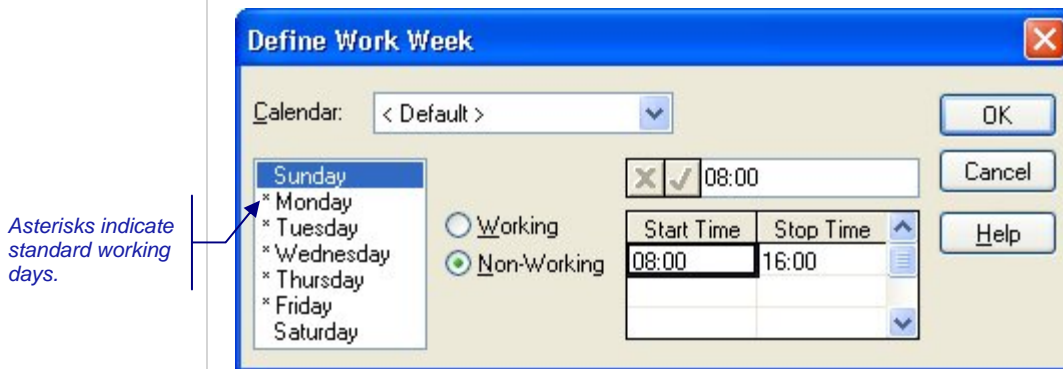

You can define up to 10 working periods for each working day.

To define the standard workweek

1. Open the appropriate calendar file.
2. Take one of the following actions:
 - On the **Edit** menu, click **Define Work Week**.
 - Right-click the calendar display, and click **Define Work Week** on the context menu.
3. From the **Calendar** list, select the name of the calendar for which you want to define the workweek.
4. Select one or more days from the list, and click **Working** or **Non-Working**.
5. For working days, enter the work start and stop times.

When entering start and stop times, the following conditions apply:

- You must enter a start and stop time for each period. The start time of a period cannot be earlier than the stop time of the previous period.
- You can define working times for more than one day at a time. Select multiple days by dragging in the list or by pressing the **Shift** key in combination with the **Up** or **Down arrow** key. Then enter the working times.

- If you enter work times using a 24-hour format (where, for example, 22:00 represents 10:00 P.M.), you cannot define a work period that spans midnight by entering a time such as 26:00.

6. When the definition of the workweek is complete, click **OK**.

Entering Calendar Information

When you open a calendar file, Open Plan displays the information for the first calendar in the file. This display allows you to view an entire year at one time.

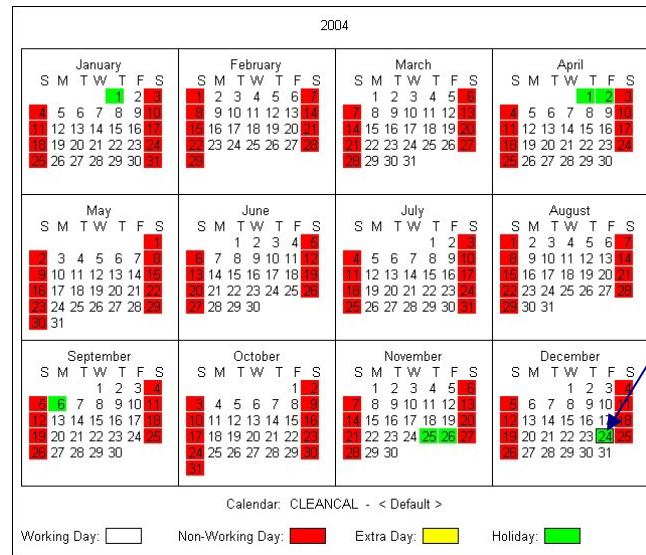

Press the **Spacebar** to change the working status of a day. Press **Ctrl+Spacebar** to change the working hours.

You can also use the keyboard to move through the calendar dates as follows:

Key	Action
Left arrow	Go to previous day
Right arrow	Go to next day
Ctrl+Left arrow	Go to same day in previous month
Ctrl+Right arrow	Go to same day in next month
Up arrow	Go to same day in previous week
Down arrow	Go to same day in next week
Page Up	Go to previous year
Page Down	Go to next year
Home	Go to first day of year
End	Go to last day of year

To change the work status of a day, you can simply select the day and press the **Spacebar**. You can also double-click a date or press **Ctrl+Spacebar** to display the working hours for a date:

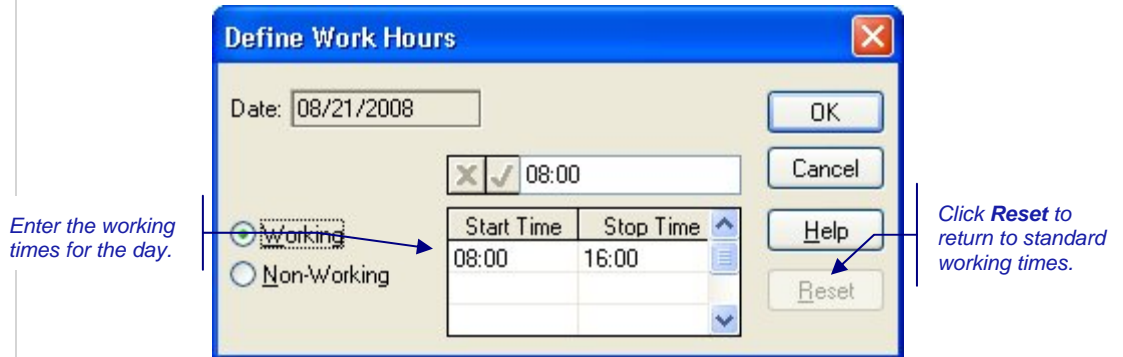

Unless you specify otherwise, the working times for a day default to the definition for that day in the standard workweek. If standard working times have not been defined for the day, Open Plan defaults to an 8-hour workday — 8:00 A.M. to 4:00 P.M.

To change the work status of a day

- Take one of the following actions:
 - Select the day, and press the **Spacebar**.
 - Double-click the date, and click **Working** or **Non-Working** on the **Define Work Hours** dialog box.
 - Right-click the date, and click **Working** or **Non-Working** on the context menu.

To define working hours for a day

- To display the **Define Work Hours** dialog box, take one of the following actions:
 - Double-click the date.
 - Select the date, and press **Ctrl+Spacebar**.
 - Select the date, and click **Define Work Hours** on the **Edit** menu.
 - Right-click the date, and click **Define Work Hours** on the context menu.
- Define the work times for the selected days.
- To restore the working hours to the standard workweek for that calendar, click **Reset**.
- To return to the calendar, click **OK**.

To go to a specific date

- Take one of the following actions:
 - On the **View** menu, click **Go To Date**.
 - Right-click the calendar display, and click **Go To Date** on the context menu.
- Enter the date you want to display, and click **OK**.

Open Plan displays the appropriate year with the date selected.

If you did not enter a year for the date, Open Plan assumes the current year.

To go to the previous year

1. Take one of the following actions:
 - Press **Page Up**.
 - On the toolbar, click the **Previous Year** button.
 - On the **View** menu, click **Previous Year**.
 - Right-click the calendar display, and click **Previous Year** on the context menu.

 Previous Year button

To go to the next year

1. Take one of the following actions:
 - Press Page Down.
 - On the toolbar, click the Next Year button.
 - On the View menu, click Next Year.
 - Right-click the calendar display, and click Next Year on the context menu..

 Next Year button

Setting Up a Holiday List

In Open Plan, holidays are standard or extra working days that have been designated as non-working. You can define each holiday individually, or if you prefer, you can enter and maintain the holidays for a calendar as a list:

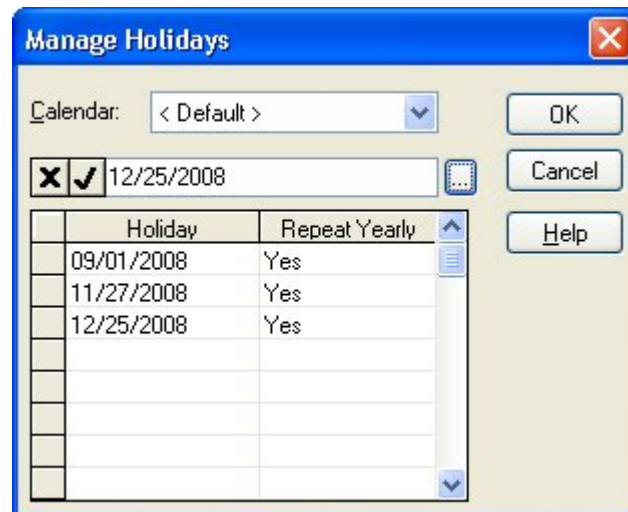

You can define holidays that repeat each year. For example, you might define January 1 as a repeating holiday.



You can enter a holiday on a non-working day only if the holiday is repeated yearly. If it is not repeated yearly, Open Plan continues to display the day as non-working.

If a given date is defined as a holiday in a parent calendar, it is marked with the holiday color in all its child calendars. However, the date is not identified as a holiday on the **Manage Holidays** dialog box displayed from the child calendar. The dialog box shows only those holidays defined for that child calendar from which it is accessed.

To enter a list of holidays

1. Open the appropriate calendar file.
2. Take one of the following actions:
 - On the **Edit** menu, click **Manage Holidays**.
 - Right-click the calendar display, and click **Manage Holidays** on the context menu.
3. From the **Calendar** list, select the name of the calendar for which you want to define holidays.
4. Enter the date for the holiday, and indicate whether the holiday is to be repeated each year.
5. When finished, click **OK**.

Working with Calendars

Open Plan offers a number of ways to manage the calendars in a calendar file:

- You can add a new calendar that is based on the default calendar for the calendar file.
- You can add a calendar as a child of an existing calendar.
- You can create a new calendar by copying an existing calendar.
- You can rename an existing calendar.
- You can delete a calendar from the file.

To perform these functions, use the **Manage Calendars** dialog box:

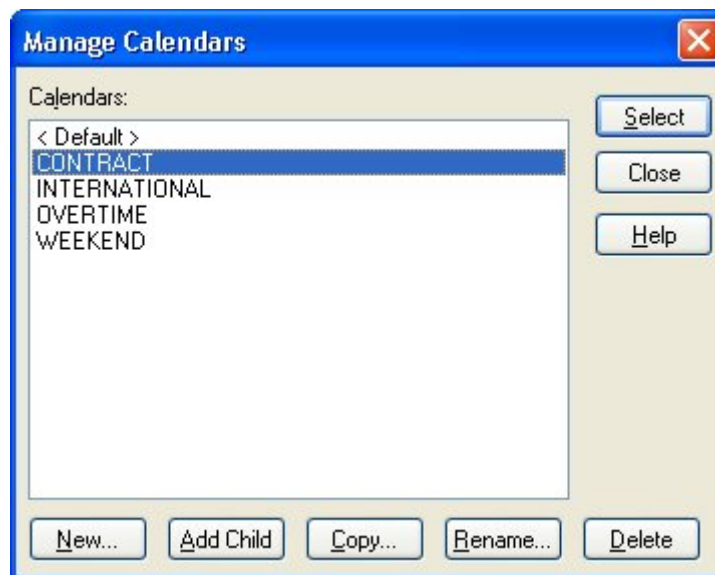



For a description of how to add a new calendar to a calendar file, refer to the "Adding Calendars" section in this chapter.

To add a new calendar as a child of an existing calendar

1. Open the appropriate calendar file.
2. Take one of the following actions:
 - On the **Edit** menu, click **Manage Calendars**.
 - Right-click the calendar display, and click **Manage Calendars** on the context menu.
3. In the **Manage Calendars** dialog box, select the calendar to which you want to add a child.
4. Click **Add Child**.
5. Enter the name for the child calendar, and click **OK** to return to the **Manage Calendars** dialog box.



Notice that the parent portion of the calendar name is automatically entered for you.

To copy a calendar

1. Open the appropriate calendar file.
2. Take one of the following actions:
 - On the **Edit** menu, click **Manage Calendars**.
 - Right-click the calendar display, and click **Manage Calendars** on the context menu.
3. In the **Manage Calendars** dialog box, select the calendar you want to copy.
4. Click **Copy**.
5. Enter the name of the new calendar, and click **OK** to return to the **Manage Calendars** dialog box.

To rename a calendar

1. Open the appropriate calendar file.
2. Take one of the following actions:
 - On the **Edit** menu, click **Manage Calendars**.
 - Right-click the calendar display, and click **Manage Calendars** on the context menu.
3. In the **Manage Calendars** dialog box, select the calendar you want to rename.
4. Click **Rename**.
5. Enter the new name for the calendar, and click **OK** to return to the **Manage Calendars** dialog box.

To delete a calendar

1. Open the appropriate calendar file.
2. Take one of the following actions:
 - On the **Edit** menu, click **Manage Calendars**.
 - Right-click the calendar display, and click **Manage Calendars** on the context menu.
3. In the **Manage Calendars** dialog box, select the calendar you want to delete.
4. Click **Delete**.
5. When Open Plan asks you to confirm the deletion, click **Yes** to return to the **Manage Calendars** dialog box.



Deleting a calendar from a calendar file removes any assignments for that calendar in a project.

Controlling the Display of Calendars

Open Plan offers a number of settings that allow you to control how calendar information is displayed.

The **Layout** tab of the **Calendar Preferences** dialog box controls how Open Plan arranges dates in a calendar.

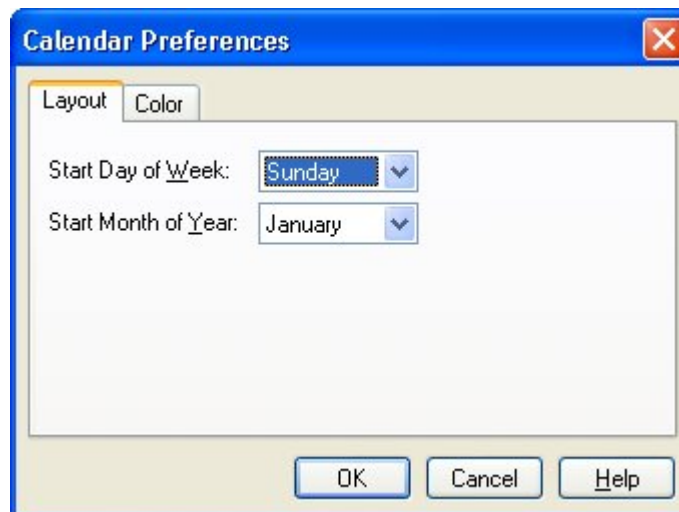

The following options are available:

- **Start Day of Week** — You can define which day is displayed as the first day of each week.
- **Start Month of Year** — You can define which month is used to start the year. This allows you, for example, to display calendars that show fiscal rather than chronological years.

Use the **Color** tab of the **Calendar Preferences** dialog box to define a color and a fill pattern for the different types of days in a calendar.

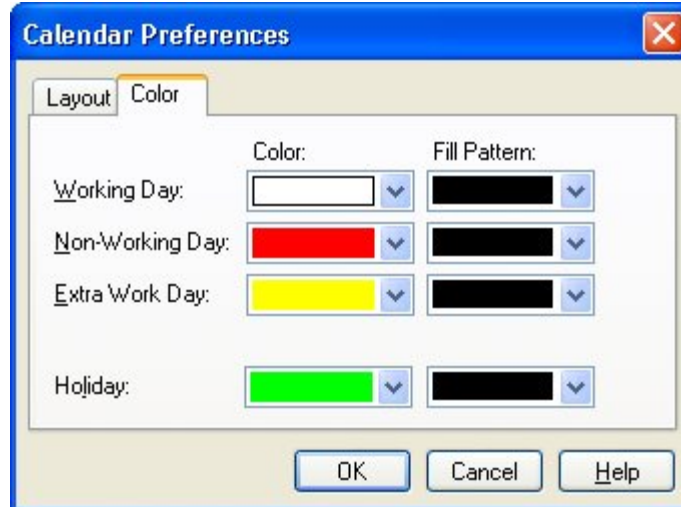

You can also set the font for the calendar display with the **Font** command from the **Tools** menu.

To set calendar preferences

1. Take one of the following actions:
 - On the **Tools** menu, click **Preferences**.
 - Right-click the calendar display, and click **Preferences** on the context menu.
2. In the **Calendar Preferences** dialog box, select the appropriate tab, and enter the information for your preferences.
3. When your changes are complete, click **OK** to return to the calendar.

To change the calendar font

1. Take one of the following actions:
 - On the **Tools** menu, click **Font**.
 - Right-click the calendar display, and click **Font** on the context menu.
2. In the **Font** dialog box, select the font and style for the calendar.
3. When your changes are complete, click **OK** to return to the calendar.

10

Cost Information

➤ Overview	247
➤ Earned Value Management	248
➤ Planning Costs	251
➤ Progress and Cost	255
➤ Cost Reporting	261

Overview

Managing the cost of a project may be at least as important as managing the schedule for most project managers. Yet the cost management functions provided by most project management packages seldom yield satisfactory results — in large part because these types of cost systems cannot cope with the wide variety of methods employed by different organizations to plan, track, and report on costs. In Open Plan, cost-related features are designed to provide basic functionality while allowing planners and managers the maximum amount of flexibility to set up cost management systems tailored for their specific environments.

This chapter begins with a brief discussion of basic earned value management concepts and then examines each of the following topics in turn:

- Planning costs
- Setting the Performance Measurement Baseline
- Capturing actual costs
- Reporting on costs



If you require extensive cost management and reporting features for your projects, Deltek Cobra, Deltek's cost management software, may be more appropriate to your needs. Cobra is a powerful and sophisticated earned value management package that can use project-related data generated by Open Plan. For more information about Cobra, contact your Deltek representative.

Earned Value Management

Although it is possible to set up a rudimentary cost management system that simply tracks budgeted and actual costs for a project, most organizations find such an approach far too limiting. Budgeted and actual costs do not, in themselves, provide enough information for a manager to determine if the work currently in progress is, in fact, over- or under-budget. For example, assume you have planned an activity with an initial budget of \$1000 spread evenly over the course of the activity. Midway through its planned duration, the activity has recorded actual costs of \$500. Is the activity over or under budget? That depends entirely on an estimate of the physical completion of the activity. If the activity has achieved only 25% of its intended results, for example, it is clearly over budget — it has taken \$500 to achieve what was originally planned to cost \$250. If the activity is 50% complete, however, the same actual costs indicate that the activity is being performed according to its budget.

Since earned value is measured as a percentage of the budget, it is necessary to create a Performance Measurement Baseline (PMB) against which performance, or earned value, is measured. The PMB is a copy of the project plan at the beginning of the project and represents the approved budget. When approved budget changes occur, these changes are reflected in the PMB. Thus, you have a separation between the forecasted cost and the approved budgeted cost once the project is underway.



For information on creating a PMB, refer to Chapter 16, “Status Information.”

Measuring the work performed against a performance measurement baseline is typically called an earned value management system. To establish the systematic accounting of earned value, a project manager must have access to the following information:

- Performance Measurement Baseline
- Physical percent complete (an estimate of the work that has actually been performed by Time Now)
- Actual costs to date
- Forecast

With this information, the five principal elements of earned value cost control can be defined:

- **Budgeted cost of work scheduled (BCWS)** — The budgeted cost of the work that should have been completed to Time Now, according to the PMB.
- **Budget at complete (BAC)** — The total budgeted cost of the work according to the PMB.
- **Budgeted cost of work performed (BCWP)** — The budgeted cost of the actual portion of the scheduled work that has been completed (or earned value)
- **Actual cost of work performed (ACWP)** — The actual costs expended to perform the work completed
- **Estimate at Complete (EAC)** — The estimated remaining costs plus the actual costs expended.

Typically, these values are represented as cumulative cost curves in graphic displays:

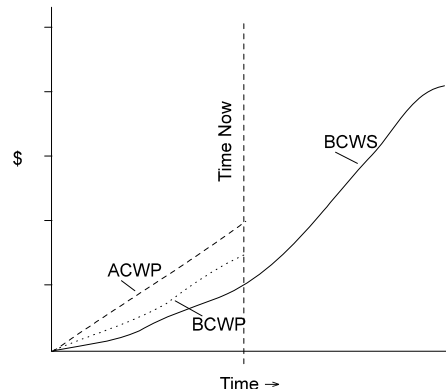

Taken together, these values (BCWS, BAC, BCWP, ACWP, and EAC) form the core of an earned value cost control system.

Cost and Schedule Variances

Once the principal elements of cost control are established, two important variances can be calculated: cost variance and schedule variance.

Cost variances are calculated by subtracting ACWP from BCWP:

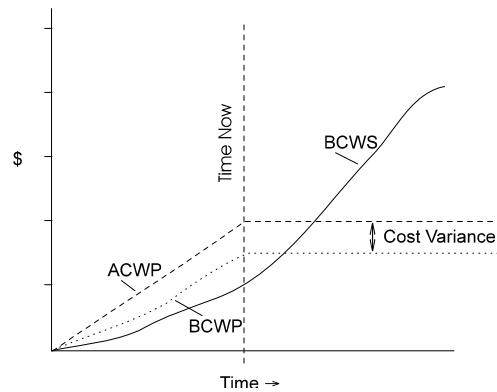

Using this convention, a “favorable” cost variance (that is, a cost underrun) is represented by a positive value while a negative value represents an “unfavorable” cost variance (a cost overrun).

We can also use the same set of curves to calculate schedule variances by subtracting BCWS from BCWP:

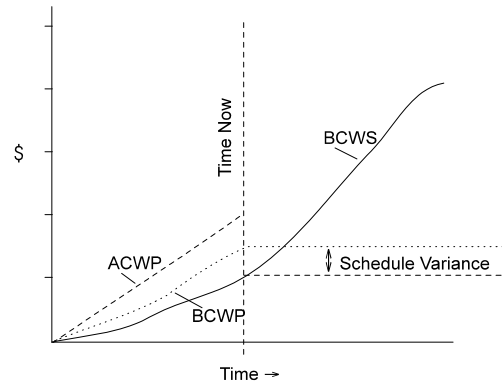

As in the case of cost variances, “favorable” schedule variances are represented as positive values while “unfavorable” variances produce negative values.

As you can see, the budget does not figure in calculating the cost variance while the actual cost expended does not figure in calculating the schedule variance. The link between the two variances is BCWP or earned value, which is used as the starting point for both calculations.

Using BCWP in this manner makes it possible to measure schedule variance in terms of cost (for example, dollars) or hours. This may seem strange, but this value gives a convenient summary of the budget, actual cost, and project status in numbers that can be compared to each other. Keep in mind, however, that this approach is not a true alternative to critical path scheduling for measuring the likely impact of potential delays since the amount budgeted for particular activities may or may not accurately reflect the importance of those activities to the overall schedule of the project.

Planning Costs

For planners who want to fully utilize Open Plan as an earned value management system, there are a number of features for working with cost information.

- You can report on high-level summaries of resource costs based on the resource category or the hierarchy of a resource breakdown structure.
- You can choose which resources to consider in cost calculations.
- You can define escalated and unescalated rates for resources, resource pools, and skills.

Setting Up Categories

If you wish to roll up resource costs into categories, you need to specify the appropriate category for the resource. There are four resource categories:

- Labor
- Material
- Other Direct Costs
- Subcontract

You can select a resource's category on the **General** tab of the **Resource Details** dialog box:

The screenshot shows the 'Resource Details [CLEANRES]' dialog box with the 'General' tab selected. The 'ID' field contains 'RES.EQUIP.TEST' and the 'Desc' field contains 'Testing Equipment'. The 'Type' dropdown is set to 'Normal' and the 'Category' dropdown is set to 'Material'. The 'Unit' is 'Equip-hr', 'Unit Cost' is '200', and 'Threshold' is '0'. The 'Project' dropdown is set to '< None >'. The 'Email Address' field is empty. At the bottom, there are several checkboxes: 'Suppress in Lists' (unchecked), 'Suppress for Scheduling' (unchecked), 'Roll up for Scheduling' (unchecked), 'Progress Based on Activity Progress' (checked), 'Actual Cost Based on Progressed Quantity' (checked), and 'Consider in Cost Calculations' (checked). A blue arrow points to the 'Category' dropdown with the text 'Select resource category.'

Selecting the **Progress Based on Activity Progress** option instructs Open Plan to calculate the actual and remaining resource requirements based on the activity progress during progress calculations. Select the **Consider in Cost Calculations** option if you want these resource costs to appear in the cost summaries.



For more information on using the **General** tab of the **Resource Details** dialog box, refer to Chapter 7, "Resource Definitions."

Setting up Resource Rates

For each resource, you should enter a base unit cost. If the resource is a **Labor** resource, the units are typically hours and the unit cost will be the present value of the direct labor rate. If the resource is a **Material** or **Other Direct Cost**, unit cost is typically 1 and the units are dollars. However, if you have very large dollar values, you can enter units of 1000 and enter the resource level in thousands of dollars. Depending on your needs, **Subcontract** resources may be treated as either labor or material. As an option, you can also define a set of escalations for the cost.



For more information on setting up resource files and defining resources, refer to Chapter 7, "Resource Definitions."

Assigning Resources

To define budgets using resources, you must first define the resources in a resource file and then attach the resource file to the project. Then you add resource assignments to the activities:

Resource assignment

Material assignment

SKIND	Resource ID	Res. Curve	Res. Level	Alternate Res. ID
	RES.LAB.ENG.CIV.JIM		2.00	
	PROJECT.MATERIAL		500.00	

You can define the assignment as a total to be spread based on a curve. This allows you, for example, to enter budgets as totals that are front- or back-loaded over the duration of the activity. By using a total, the budget does not change as the duration changes. Resources can also be assigned as a rate per day by leaving the curve field blank.



For more information on attaching resource files to projects, refer to Chapter 7, "Resource Definitions." For more information on entering resource assignments, refer to Chapter 8, "Resource Assignments."

Calculating Costs

Open Plan calculates costs and stores them at the detail level, allowing you to store time-phased quantity, cost, and escalated cost by resource and activity. All activity costs represent a roll up of these detailed costs. Because open Plan stores

both costs and quantities, the resource rates that are in effect when the progress is calculated are locked in.



For more information on how detail costs are calculated, refer to Chapter 12, "Cost Calculations," in the *Deltek Open Plan Developer's Guide*.

Once you have assigned resources to your activities, you can have Open Plan roll up these costs to the activity level. To calculate budget costs for activities, click **Cost Calculations** on the **Tools** menu to display the following dialog box:

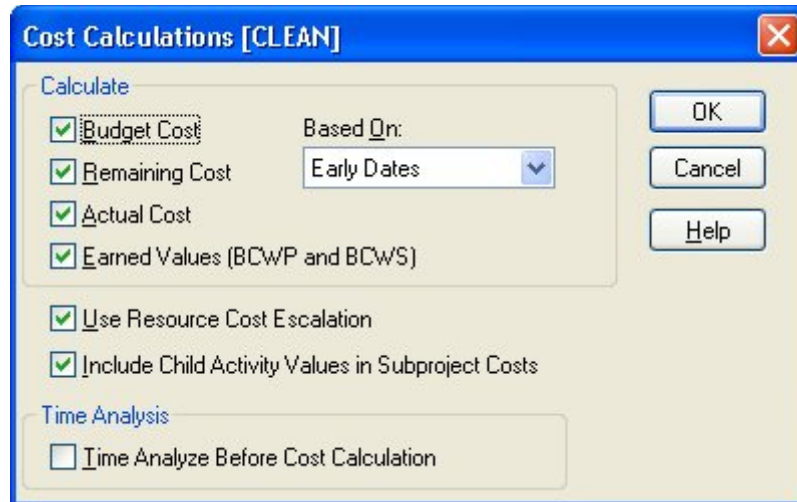

Using this dialog box, you can indicate the following settings for the calculation of costs:

- You can select the cost values to calculate:
 - Budget Cost
 - Remaining Cost
 - Actual Cost,
 - Earned Value
- You can base the **Remaining Cost** calculations on early, late, or scheduled dates.
- You can indicate if Open Plan should use only base unit costs for the calculation or consider cost escalations as well.
- You can include child activity values in subproject costs.
- You can run Time Analysis before calculating cost to make sure that dates are current for the calculation of **Remaining Cost**.

Group Process Cost Calculations

You can also perform cost calculations in **Batch Mode**. This allows you to run cost calculations for multiple projects at one time. To run cost calculations in **Batch Mode**, select more than one project from the **Details** pane of the Open Plan Explorer, and click the **Cost Calculations** button. The **Cost Calculations [Batch Mode]** dialog box will be displayed. Set your options, and click **OK**.

If a project is closed, Open Plan will open it in **Exclusive** mode, perform the process, save the changes, and then close the project. If a project cannot be opened in **Exclusive** mode (because another user has it open in **Exclusive** or **Shared** mode), it will be skipped.

If you have a project open when the batch process is run, a cost calculation will be performed on the project, but the changes will not be saved and the project will remain open. You must manually save the changes yourself.



Cost calculations for multiple projects can also be run by selecting a group of projects and clicking the **Cost Calculation** button on the toolbar. See the previous section for toolbar procedures.



Open Plan creates one cost calculation session log, listing the project results in the order in which the projects were processed in the batch.

Budget Cost

By default, Open Plan normally calculates budget values by rolling up the (escalated/unescalated) cost from a baseline. If a PMB exists, **Cost Calculations** will use this baseline. If no PMB exists, Open Plan calculates budgets using the currently selected baseline or the first selected baseline if multiple baselines are selected.



By always using the same baseline (regardless of which baseline is selected) for calculating budgets, Open Plan provides consistency and reliability.

If no baseline (PMB or otherwise) exists, Open Plan will calculate budgets from resources directly assigned to activities as versions prior to 3.x did. You can set this as the default project behavior by selecting the **Use Version 2 Cost Calculation Method** option on the **Cost** tab of the **Project Properties** dialog box.

To calculate budget costs for activities

1. Open the project for which you want to calculate budget costs.
2. Take one of the following actions:
 - On the **Tools** menu, click **Cost Calculations**.
 - On the toolbar, click the **Cost Calculations** button.
3. In the **Calculate Costs** dialog box, select **Budget Cost**.
4. Set the options for the operation, and click **OK**.

Creating and Using a Baseline

Once your project is well-planned and the schedule and resource loading is the way you want it, you will want to create a performance measurement baseline (PMB). Creating a PMB ensures that all future budget and earned value calculations will be based on these values.



For information on creating a PMB, refer to Chapter 16, "Status Information."

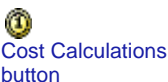

Progress and Cost

The following sections discuss how to progress an activity by entering the physical percent complete and resource progress and how it impacts earned value, actual costs, and forecast.

Entering Physical Percent Complete

Open Plan allows you to progress an activity by entering the physical percent complete (PPC) at either at the activity level or the resource level.

To status an activity, display the **Activity Progress** dialog box:

On the **Activity** tab, you can enter an actual start date and select one of the statusing methods.

Resource	Phy. %	Qty	Actual	Remaining	Previous	Budget
MECH.IKE	0.00	Qty		60.00	0.00	60.00
		Cost		2700.00	0.00	2700.00

On the **Resources** tab, you can enter the PPC for each resource, or you can have Open Plan calculate the PPC based on the activity progress. If you enter the PPC at the resource level, Open Plan calculates the activity PPC for you based on the rolled up earned value of each resource. If you enter the PPC at the activity level, Open Plan calculates each resource's PPC with regard to duration, curve, offsets, and periods.

You can also have Open Plan calculate physical percent complete for you based on activity progress using the **Progress Calculations** dialog box.



For more information on using the **Progress Calculations** dialog box, refer to Chapter 16, "Status Information." For a detailed discussion on how Open Plan calculates PPC at both the resource level and activity level, refer to Chapter 12, "Cost Calculations," in the *Deltek Open Plan Developer's Guide*.

Calculating Earned Value

Open Plan calculates earned value by multiplying the physical percent complete by the budget cost.



For more information about calculating earned value, refer to Chapter 12, "Cost Calculations," in the *Deltek Open Plan Developer's Guide*.

To calculate earned value

1. Open the project for which you want to calculate earned value.
2. Take one of the following actions:
 - On the **Tools** menu, click **Cost Calculations**.
 - On the toolbar, click the **Cost Calculations** button.
3. In the Calculate Costs dialog box, select Earned Values (BCWP and BCWS).
4. Click OK.



Cost Calculations
button

Capturing Actual Costs

You can capture actual costs in the following ways:

- Entering actual costs manually on the **Resources** tab of the **Activity Progress** dialog box
- Calculating actual costs based on reported progress
- Importing actual costs from a third-party system

Entering Actual Cost

If you plan to enter actual costs manually (or to import actual costs using the **Import General** utility), you must clear the **Actual Cost Based on Progressed Quantity** option on the **General** tab or the **Resource Details** dialog box:

Resource Details [CLEANRES]

General Code Availability Escalation Skills User Fields Notes

ID: RES.EQUIP.TEST

Desc: Testing Equipment

Type: Normal Category: Material

Unit: Equip-hr Effort Factor: 1

Unit Cost: 200 Employee ID:

Threshld: 0

Project: < None >

Email Address:

Suppress in Lists Progress Based on Activity Progress

Suppress for Scheduling Actual Cost Based on Progressed Quantity

Roll up for Scheduling Consider in Cost Calculations

Close Undo Apply New Help

If you select this option, the actual costs for a resource will be calculated and posted to the file when you run progress calculations. The actual costs posted will be calculated from the actual units (reported or calculated) multiplied by the resource rate.

To enter actual costs manually, you use the **Resources** tab of the **Activity Progress** dialog box:

Activity Progress [CLEAN]

Activity Resources Notes

ID: 1.01.01 Activity Physical % Complete: 0

Desc.: Requirements Coordination & Planning Start Date: End Date:

RES.LAB.ENG.MECH.IKE - Ike Hamlin

Resource	Phy. %	Actual	Remaining	Previous	Budget
RES.LAB.ENG.MECH.IKE	0.00 Qty		60.00	0.00	60.00
(Ike Hamlin)	Cost		2700.00	0.00	2700.00

Close Undo Apply Help

Since actual costs are spread over a date range, you must enter the start of the period for which you are entering actual costs; the end date is not required. You can enter both the actual quantity and actual cost for each resource.

To add a new resource that was unbudgeted, add it to the bottom of the list.



For information about entering resource progress, refer to Chapter 16, "Status Information."

Calculating Actual Costs

Open Plan calculates activity actual cost during the cost calculations process by rolling up user-entered actual costs or by multiplying the actual quantity by the resource rate for resources set to automatically calculate costs.

To calculate actual costs for activities, use the **Cost Calculations** command to display the following dialog box:

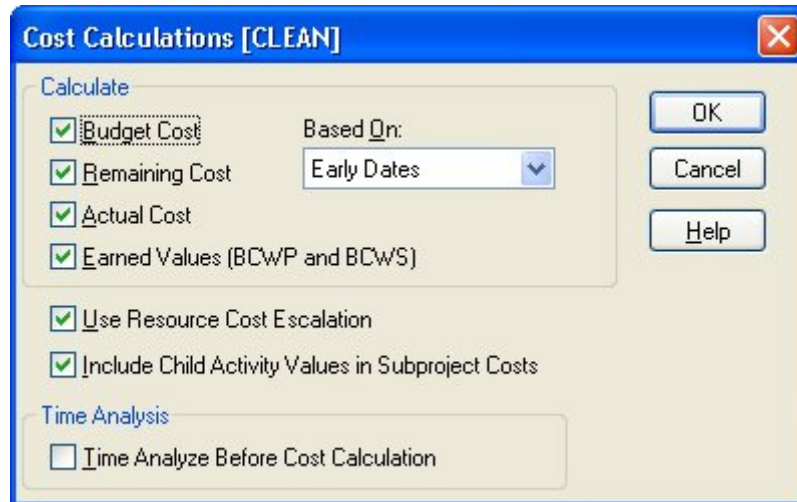

If you indicated that Open Plan should calculate actual costs for resources based on resource progress, the **Cost Calculations** command also generates these costs at this time.

When you select **Actual Cost** or **Remaining Cost**, the cost calculations roll up the actual or remaining labor units to the activity and subproject level.



For information about generating actual costs from progress, refer to Chapter 7, "Resource Definitions," and Chapter 16, "Status Information."

To calculate actual costs for activities

1. Open the project for which you want to calculate actual costs.
2. Take one of the following actions:
 - On the **Tools** menu, click **Cost Calculations**.
 - On the toolbar, click the **Cost Calculations** button.
3. In the **Calculate Costs** dialog box, select **Actual Cost**, and click **OK**.

You can also perform cost calculations in Batch Mode. This allows you to run cost calculations for multiple projects at one time. To run cost calculations in Batch Mode, select more than one project from the Details pane of the Open Plan Explorer, and click the **Cost Calculations** button. The **Cost Calculations [Batch Mode]** dialog box displays. Set your options, and click **OK**.

If a project is closed, Open Plan will open it in Exclusive mode, perform the process, save the changes, and then close the project. If a project cannot be opened in Exclusive mode (because another user has it open in Exclusive or Shared mode), it will be skipped.



Cost Calculations
button

If you have a project open when the batch process is run, cost calculations will be performed on the project, but the changes will not be saved and the project will remain open. You must manually save the changes yourself.



Open Plan creates one cost calculations session log, listing the project results in the order in which the projects were processed in the batch.

Forecasting

Forecast of remaining cost (ETC) and work is always based on the schedule and can be calculated from early, late, or schedule dates using the remaining quantity of the resource and either escalated or un-escalated rates. If the activity has not yet started, the resource assignments on the activity are the forecast. For activities in progress, the remaining quantity and cost represent the forecast. This plus the actual costs comprise the estimate at complete. Changing the resource assignments on activities changes the forecast without changing the budget.

Viewing cost and earned value data

Once you have calculated budget costs for activities, you can display this cost information using the **Cost** tab of the **Activity Information** dialog box:

	BAC	BCWS	BCWP	ACWP	EAC
Labor Quantity	60.00	0.00	0.00	0.00	60.00
Labor Cost	2700.00	0.00	0.00	0.00	2700.00
Material Cost	0.00	0.00	0.00	0.00	0.00
ODC	0.00	0.00	0.00	0.00	0.00
Subcontract Cost	0.00	0.00	0.00	0.00	0.00
Total Cost	2700.00	0.00	0.00	0.00	2700.00

This tab displays budgeted and actual costs calculated at the activity level for the following by resource category:

- **BAC** — Budget at Completion
- **BCWS** — Budgeted Cost of Work Scheduled
- **BCWP** — Budgeted Cost of Work Performed (also referred to as Earned Value.)
- **ACWP** — Actual Cost of Work Performed
- **EAC** — Estimate at Complete

Labor Quantity values are also shown.



For more information of the costs displayed in the grid, refer to the beginning of this chapter and also the Help system for the **Activity Information Cost** tab. For more information on the **Activity Information** dialog box, refer to Chapter 6, “Activity Information.”

Finally, it is possible to display budgeted costs rolled up to the project level. To see these values, display the **Cost** tab of the **Project Properties** dialog box:

Project Properties

Summary Preferences Files Status **Cost** Notes Scheduling User Fields Access Control Open Status References Codes

Project Name: CLEAN Description: Environmental Cleanup Project

Target Total Cost: 0 Reporting Calendar: FISCAL

Use Version 2 Cost Calculation Method

	BAC	BCWS	BCWP	ACWP	EAC
Labor Quantity	7858.00	0.00	0.00	0.00	7858.00
Labor Cost	440321.00	0.00	0.00	0.00	440321.00
Material Cost	148800.00	0.00	0.00	0.00	148800.00
ODC	0.00	0.00	0.00	0.00	0.00
Subcontract Cost	0.00	0.00	0.00	0.00	0.00
Total Cost	589121.00	0.00	0.00	0.00	589121.00

OK Cancel Help



For more information of the costs displayed in the grid, refer to the online Help system for the **Project Properties Cost** tab. For more information on the Project Properties dialog box, refer to Chapter 5, “File Properties.”

Cost Reporting

To facilitate the reporting of cost information, Open Plan provides a number of standard calculated fields related to costs at the activity level. These fields are available for display in any view and are defined as follows.

Field	Description	Calculation
BACcum	Budget at complete	BAC_LAB + BAC_MAT + BAC_ODC + BAC_SUB
ACWPcum	Actual cost of work performed	ACWP_LAB + ACWP_MAT + ACWP_ODC + ACWP_SUB
BCWScum	Budgeted cost of work scheduled	BCWS_LAB + BCWS_MAT + BCWS_ODC + BCWS_SUB
BCWPcum	Budgeted cost of work performed	BCWP_LAB + BCWP_MAT + BCWP_ODC + BCWP_SUB
ETC	Estimate to complete	ETC_LAB + ETC_MAT + ETC_ODC + ETC_SUB
EAC	Estimate at complete	ACWPcum + ETC
CV	Cost variance	BCWPcum – ACWPcum
SV	Schedule variance	BCWPcum – BCWScum
VAC	Variance at complete	BACcum – EAC
CPI	Cost performance index	BCWPcum / ACWPcum
SPI	Schedule performance index	BCWPcum / BCWScum



For more information on these calculated fields, refer to Chapter 12, “Cost Calculations,” in the *Deltek Open Plan Developer’s Guide*.

In addition to these values, Open Plan calculates the planned baseline progress for each activity using the following approach:

- If no baseline dates have been set for the activity, Open Plan sets the value of planned baseline progress to –1.
- If the baseline finish date is before Time Now, Open Plan sets the value of planned baseline progress to 100%.
- If the baseline start date is after Time Now, Open Plan sets the value of planned baseline progress to zero.

If none of these cases apply, Open Plan calculates the value by first subtracting the baseline start from Time Now, dividing the result by the original duration, and then

multiplying by 100. For activities with an original duration of zero, Open Plan divides the result by the difference between the baseline start and finish dates.



The calculation of the planned baseline progress takes into account the effect of calendars in all date calculations.

11

Project Codes

➤ Overview	264
➤ Coding Systems in Open Plan	265
➤ Creating Code Files	267
➤ Using Code Files	269
➤ The Code Details Dialog Box.....	272
➤ Entering Codes	275
➤ Displaying Code Information.....	278
➤ Entering Code Assignments	283

Overview

By setting up a coding system and assigning codes to activities, projects, and resources, you can facilitate the communication of project information in formats ranging from high-level summaries to activity-level detail. With the appropriate coding system in place, even the largest networks can provide clear, concise pictures of vital project information. Open Plan allows you to assign up to 90 codes to each activity.

This chapter includes discussions on the following topics related to code files in Open Plan:

- Working with code files
- Entering codes
- Displaying code information
- Entering code assignments

Coding Systems in Open Plan

Coding systems typically describe some type of hierarchy of project information. The types of hierarchies that can be represented by coding structures can be work breakdown structures, organizational breakdown structures, or any other classification that can be represented by a hierarchy. By assigning codes based on breakdown structures to various project elements, you can summarize project and resource data to appropriate levels for specific reporting requirements.

A particular breakdown structure can be used with more than one project. This might be the case, for example, if a number of projects were being performed by the same organization and therefore could share the same organizational breakdown structure. As a result, Open Plan does not force you to define coding systems that are project- or resource file-specific. Instead, you can define a code file that is independent of a particular project or resource file and associate it with subsequent projects or resource files as needed.

Codes in Open Plan can use one of two types of self-defining coding systems — punctuated significant codes and fixed-form significant codes. The term “self-defining” refers to the ability to determine where an individual element appears in the hierarchical structure by inspecting the element’s code.

In punctuated significant coding systems, periods within the code are used to distinguish between different hierarchical levels in the structure. The following illustration shows a portion of a punctuated significant coding system that might represent a portion of a work breakdown structure. In this example, 1.1.1, 1.1.2, and 1.1.3 are children of 1.1, which is a child of 1.

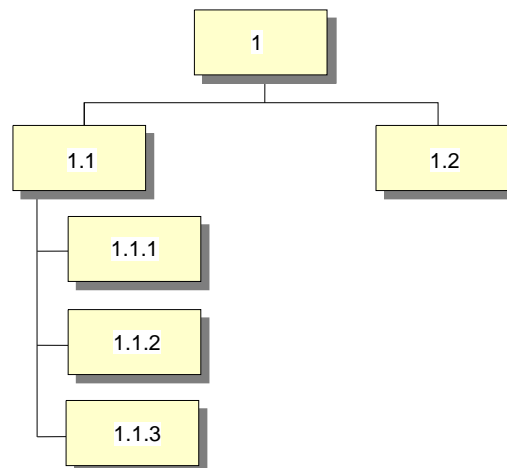

Fixed-form significant codes rely on the length of the code to represent the structure level. As a result, you must define both the number of levels in the coding system and the number of characters representing each level. In the following illustration, for example, the first character of the code represents the top level of the structure, the first two characters represent the next level, and the first three characters represent the lowest level:

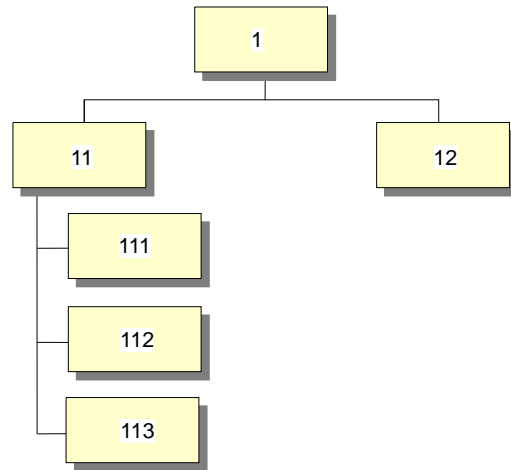

In this example, higher-level codes use spaces as “pad characters” that fill out each code in the system to the same length.

In both punctuated significant and fixed-form significant coding systems, higher-level codes are referred to as “parent” codes. All lower-level codes that are directly or indirectly connected to a particular parent may be called descendants or “children” of that code. When a report is produced at a particular level, all data associated with that code itself or any of its descendants is summarized or “rolled up” into a single set of data.

Creating Code Files

When you create a new code file using Open Plan default settings, Open Plan displays the **New Code Structure** dialog box:



When you create a new code using the **New File Wizard**, the **Code Structure** page of the wizard contains the same fields as the **New Code Structure** dialog box.

Use this dialog box to enter the following information about a new code file:

- **Code Type** — Indicates whether the code file uses punctuated significant or fixed format significant codes.
- **Fixed Level Length** — If you are creating a code file using fixed-form significant codes, you must define the number of levels in the coding structure and the number of characters representing each level. The number of characters you assign to each level is cumulative — that is, it must be greater than the number of characters assigned to the previous level. For example, to use a 7-character code that represents three different hierarchical levels, you might enter the following information:
 - Level 1: 2
 - Level 2: 4
 - Level 3: 7



You can add levels later using the **Structure** tab of the **Properties** dialog box for the code file, but you cannot change existing levels.

- **Pad Character** — If you create a code file using fixed-form significant codes, you can assign a pad character to be appended as a suffix to codes less than

the specified length. Common pad characters are blanks (the default) and zeros.



If you select **Punctuated Significant** for the **Code Type**, the **Fixed Level Length** fields and **Pad Character** field are disabled.

There are two methods for creating a code file depending on whether you want to use Open Plan default settings or define all the settings for the code file yourself.

To create a code file using default settings

1. Take one of the following actions:
 - On the **File** menu, click **New**.
 - Press **Ctrl+N**.
 - On the toolbar, click the **New** button.
 - Double-click an empty area of the Open Plan Explorer.
2. From the **File Types** list, select **Code**.
3. Enter a name and description for the code file, and click **Finish**
Open Plan displays the **New Code Structure** dialog box.
4. Enter the information for the code file, and click **OK**.
Open Plan creates a new code file and allows you to enter information for the first code.

New button

To create a code file using user-defined settings

1. Take one of the following actions:
 - On the **File** menu, click **New**.
 - Press **Ctrl+N**.
 - On the toolbar, click the **New** button.
 - Double-click an empty area of the Open Plan Explorer.
2. From the **File Types** list, select **Code**.
3. Enter a name and description for the code file, and click **Next**.
Open Plan displays the first page of the **New File Wizard**.
4. Complete each page as appropriate, and on the last page click **Finish**.
Open Plan creates a new code file and allows you to enter information for the first code.

New button

Using Code Files

Code files in Open Plan can be project- or resource file-specific, or they can be shared by multiple projects or resource files. It is possible to assign more than one code file to the same project or resource file.

If you make changes to the information in a code file, the changes will affect all of the projects or resource files to which the code file is assigned. To make changes in a code file that only affect a single project or resource file, make sure that the file is not assigned to other projects or resource files.

In the **Open Plan Explorer**, code files are located in the **Open Plan Library**:

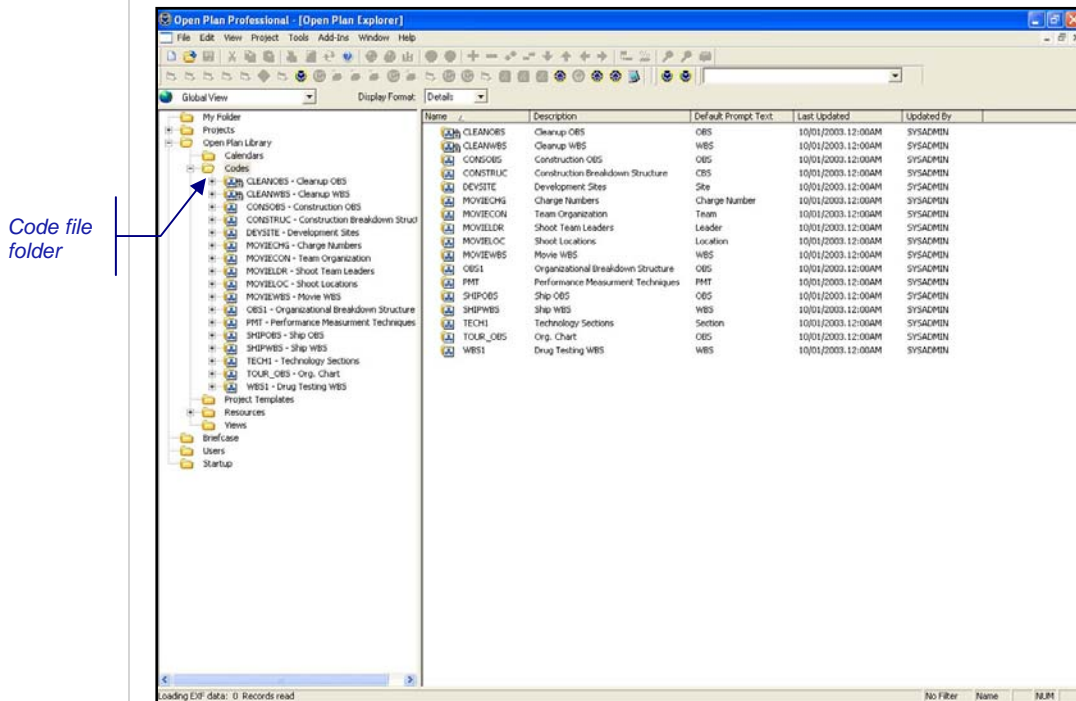

You can open code files from within either the **Open Plan Library** or a specific project or resource folder. When you assign a code file to a project or resource file, Open Plan asks you to assign the file to a specific activity code field. If you replace an existing assignment for a code field, Open Plan prompts you for confirmation.

To open a code file

1. Take one of the following actions:
 - On the **File** menu, click **Open**.
 - Press **Ctrl+O**.
 - On the toolbar, click the **Open** button.
 - Right-click the code file folder, point to **Open**, and click the desired mode in which to open the file.
 - Double-click the code view file.
 - Right-click the code view file, and click **Open** on the context menu.



To copy a code file

1. Open the code file.
2. On the **File** menu, click **Save As**.
3. Enter the name for the copy of the file, and click **OK**.



You cannot perform **Save As** on a file if there is another file open which refers to it. For example, if you open project CLEAN and then try to perform a **Save As** on the code file CLEANOBS, the **Save As** command is disabled.

To remove a code file from a project

1. Open the appropriate project.
2. Display the **Project Properties** dialog box using one of the following methods:
 - Select the project folder and click **Properties** on the **Project** menu.
 - Right-click the project folder, and click **Properties** on the context menu.
3. On the **Files** tab, click the **ellipsis** button next to the **Code Files** field.
4. In the right pane of the **Assign Code** dialog box, select the code to remove, and click **Remove**.



Repeat the above step if there is more than one code you want to remove.

5. When finished removing codes, click **OK**.
6. On the **Project Properties** dialog box, click **OK**.



Deleting a code file from a project folder removes any activity code assignments based on that code file.

To remove a code file from a resource file

1. Open the appropriate project.
2. Right-click the resource file folder, and click **Properties** on the context menu.
3. Open Plan displays the **Properties** dialog box for the resource file.
4. On the **Files** tab, click the **ellipsis** button next to the **Code Files** field.
5. In the right pane of the **Assign Code** dialog box, select the code to remove, and click **Remove**.



Repeat the above step if there is more than one code you want to remove.

6. When finished removing codes, click **OK**.

7. On the **Properties** dialog box, click **OK**.

To delete a code file from the database



You can only delete a code file from the database if the file is not open, if it is not being used by another project or resource file, and if you have the appropriate rights to the file.

1. Take one of the following actions:
 - On the **File** menu, point to **Manage Files**, and click **Delete File** on the submenu.
 - Right-click the code file folder in the hierarchical pane, point to **Manage Files**, and click **Delete File** on the submenu.
2. On the **Select File to Delete** dialog box, select the code file, and click **OK**.
3. When Open Plan asks you to confirm the deletion, click **Yes**.

To assign a code file to a project

1. Take one of the following actions:
 - Drag the code file from the **Open Plan Library** to the project folder.
 - On the **Files** tab of the **Project Properties** dialog box, click the **ellipsis** button to the right of the **Code Files** field.
2. In the **Assign Code** dialog box, indicate the code field to which you want to assign the file.
3. When done, click **OK**.

To assign a code file to a resource file

1. Take one of the following actions:
 - Drag the code file from the **Open Plan Library** to the resource folder.
 - On the **Files** tab of the resource file's **Properties** dialog box, click the **ellipsis** button to the right of the **Code Files** field.
2. In the **Assign Code** dialog box, indicate the code field to which you want to assign the file.
3. When done, click **OK**.

The Code Details Dialog Box

Open Plan automatically displays the **Code Details** dialog box each time you add or edit a code in a code file.

You can display the **Code Details** dialog box for an existing code by double-clicking the code, selecting the code and clicking **Edit Code** on the **Edit** menu, or by right-clicking the code and clicking **Edit** on the context menu.

Because you can update multiple codes without having to close the **Code Details** dialog box each time, Open Plan automatically saves any changes you make to a code before displaying the next record. Notice also that the **OK** and **Cancel** buttons found on many dialog boxes have been replaced with the following buttons:

- **Close** — Closes the dialog box and returns to the code view. If you have not saved the information currently displayed, Open Plan saves the changes before returning to the display.
- **Undo** — Returns the dialog box to its previous state.
- **Apply** — Saves the changes you have made to the current record.



You must update information for a code before the **Undo** and **Apply** buttons become active.

You can also use the **New** command to create a new code element while the **Code Details** dialog box is open. This command functions identically to the **Add Code** command available from the **Edit** menu.

The **Code Details** dialog box contains three tabs: **Code**, **User Fields**, and **Notes**.

The Code Tab

When you click the **Code** tab on the **Code Details** dialog box, the following is displayed:

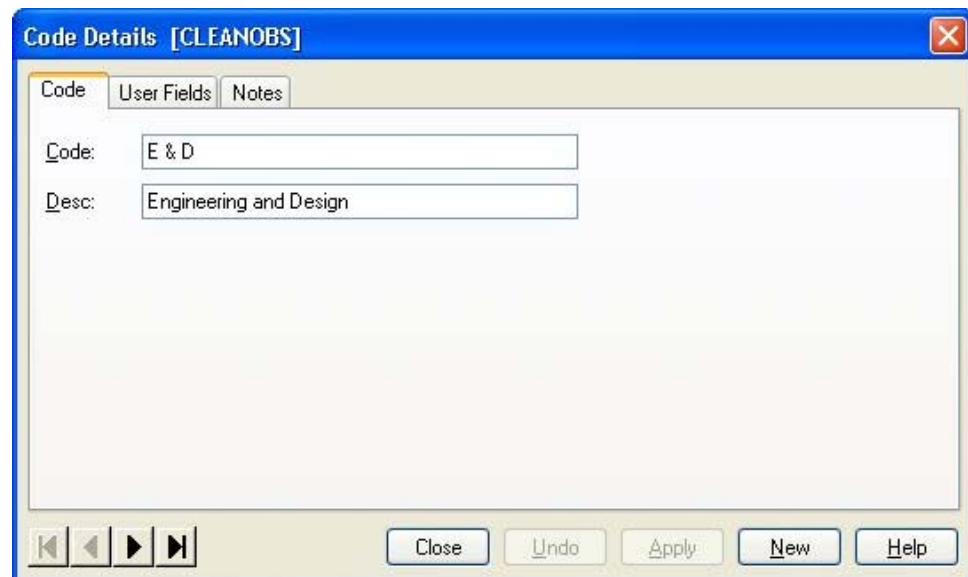

This tab allows you to enter the following information:

- **Code** — An alphanumeric identifier unique to the code. At each hierarchical level, this identifier can consist of a maximum of 10 characters. However, the total length of the code, including periods, cannot exceed 59 characters.
- **Desc** — An extended description of up to 60 characters can be stored for each code.

The User Fields Tab

When you click the **User Fields** tab on the **Code Details** dialog box, the following is displayed:

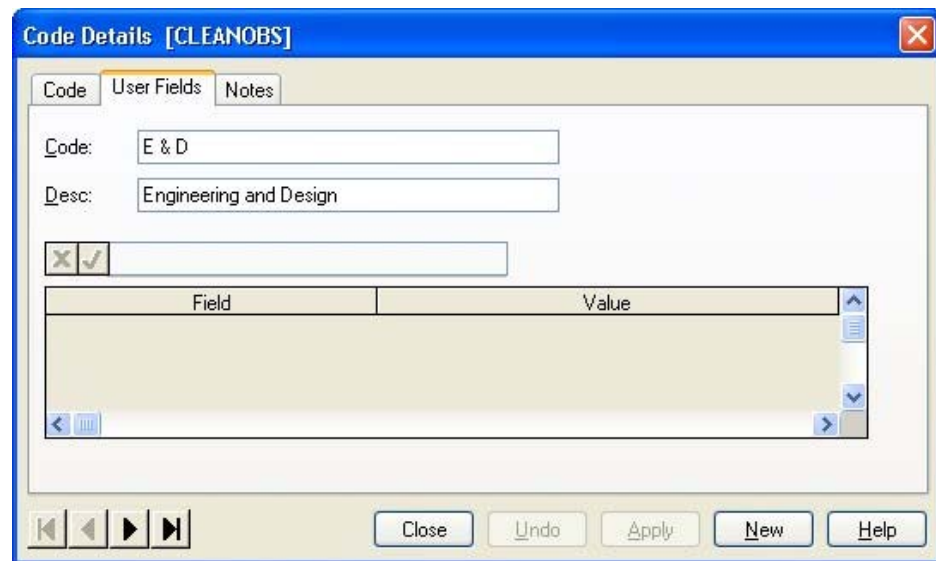

The screenshot shows the 'Code Details [CLEANOB]' dialog box with the 'User Fields' tab selected. The 'Code' field contains 'E & D' and the 'Desc' field contains 'Engineering and Design'. Below these fields is a table with two columns: 'Field' and 'Value'. The table is currently empty. At the bottom of the dialog are several buttons: 'Close', 'Undo', 'Apply', 'New', and 'Help'. There are also navigation arrows on the left side of the dialog.

This tab allows you to specify the values that Open Plan should include for user-defined fields on the code, using the following fields:

- **Field** — This column displays a list of all the user-defined fields that have been defined.
- **Value** — For each user-defined field that you want to use, you should enter an appropriate value.



User-defined fields are created outside of an open code and may be used by any code file stored in the database. In order to use a user-defined field for your code, you must specify a value for it on this tab.

The Notes Tab

When you click the **Notes** tab on the **Code Details** dialog box, the following is displayed:

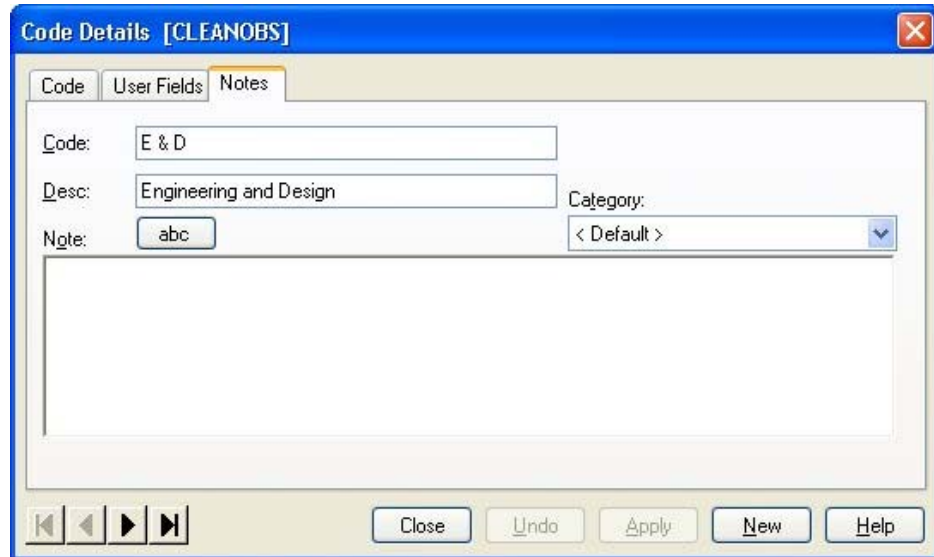

You can use the following fields to attach a note to a code:

- **Note** — This text box can contain up to 29 KB of text. You can enter the text by typing directly in this field or by using the Windows **Cut (Ctrl+X)**, **Copy (Ctrl+C)**, and **Paste (Ctrl+V)** commands to insert text from another Windows application such as a word processor or spreadsheet.
- **Category** — This field controls the category of the note. You can select a category from the list of global categories.

Clicking the **abc** button checks the spelling of the text you enter.

You can enter links to files, Web pages, and e-mail addresses by entering the information in one of the following formats:

- File links must be entered in the format of: <file://c:\document.doc>



If the file link you enter contains spaces, you must enclose the link with angle brackets (< >) in order for the link to work properly: **<file://C:\Documents and Settings\All Users\Desktop\test.txt>**

- Universal Resource Locators (URLs) must be entered in the format of: **http://deltek.com**
- E-mail addresses must be entered in the format of: <mailto:sales@deltek.com>



While you can use drag and drop functionality to create links in the **Note** field, the Windows **Cut (Ctrl+X)**, **Copy (Ctrl+C)**, and **Paste (Ctrl+V)** commands are not available for links.

Entering Codes

When you create a new code file, Open Plan displays a window containing an empty workspace. To add a code to the file, click **Add Code** on the **Edit** menu or simply double-click an empty area in the workspace.

Although you can define a code file as a “flat” structure in which all codes occupy the top hierarchical level, a more common practice is to develop a tree-like breakdown structure that can be used to summarize groups of related codes for reporting purposes:

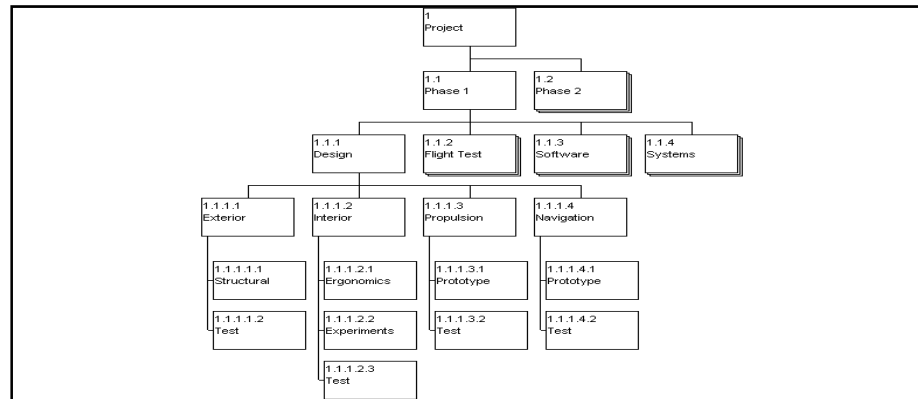

Open Plan makes it easy to work with code hierarchies. For example, you can assign an entire group of codes to a different parent simply by dragging the codes to a different position in the code hierarchy. You also have the ability to expand and collapse individual codes in order to display the appropriate level of detail.

To add a code

- From the code display, take one of the following actions:
 - On the **Edit** menu, click **Add Code**.
 - Double-click an empty area of the workspace.
 - Right-click an empty area of the workspace, and click **Add Code** on the context menu.
- Enter the information for the code in the **Code** dialog box.



You can rearrange the order in which Open Plan displays codes from left to right on the same hierarchical level by dragging a code to the desired location.

To add a child

- Take one of the following actions:
 - Right-click the code to which you want to add a child, and click **Add Child** on the context menu.
 - Double-click the code while holding down the **Shift** key.



If you add a child to a normal code, Open Plan automatically converts the code to a parent.

2. Enter the information for the code.
3. When the information is complete, click **Close**.

To edit a code

1. Take one of the following actions:
 - Double-click the code.
 - Select the code you want to update, and click **Edit Code** on the **Edit** menu.
 - Right-click the code, and click **Edit** on the context menu.
2. Enter the information for the code.
3. When the information is complete, click **Close**.

To find a code

1. Take one of the following actions:
 - On the **Edit** menu, click **Find**.
 - Right-click an empty area of the workspace, and click **Find** on the context menu.
2. Enter the ID of the code you want to find, and click **OK**.

To delete a code

1. Select the code you want to delete.
2. Take one of the following actions:
 - On the **Edit** menu, click **Delete Code**.
 - Right-click the code and click **Delete** on the context menu.
 - Press the **Delete** key.



If you are deleting a parent code, Open Plan warns you that the child codes will be deleted along with the parent.

3. When Open Plan asks you to confirm the delete, click **OK**.



If you delete a code that has been assigned to an activity in a project, that assignment is deleted as well.

To move a code in the hierarchy

- Drag the code to the desired position in the code hierarchy.
- To move the code to the top level of the hierarchy, drag the code to the top of the workspace.
- If you move a parent, all child codes of the parent are moved as well.



When you move a code (or group of codes) to a different position in the code hierarchy, Open Plan automatically renumbers the code IDs of the moved codes. If this renumbering potentially duplicates existing code IDs, Open Plan allows you to renumber the codes yourself. In addition, Open Plan also updates the assignments for renumbered codes in any projects that are open at the time of the move. (Assignments in closed projects are not affected.)

To collapse a parent code

1. Select the code you want to collapse.
2. Take one of the following actions:
 - On the **View** menu, click **Collapse**.
 - Right-click the code, and click **Collapse** on the context menu.
 - On the toolbar, click the **Collapse** button.

To collapse all parent codes

1. Take one of the following actions:
 - On the **View** menu, click **Collapse All**.
 - On the toolbar, click the **Collapse All** button.

To expand a parent code

1. Select the code you want to expand.
2. Take one of the following actions:
 - On the **View** menu, click **Expand**.
 - On the **View** menu, clear **Collapse**.
 - Right-click the code, and clear **Collapse** on the context menu.
 - On the toolbar, click the **Expand** button.

To expand all parent codes

1. Take one of the following actions:
 - On the **View** menu, click **Expand All**.
 - On the toolbar, click the **Expand All** button.

 Collapse button

 Collapse All button

 Expand button

 Expand All button

Displaying Code Information

Open Plan provides a number of features related to the display of code information:

- Display options
- Box layout definition
- The **Zoom Out** and **Zoom In** commands

Each of these features is described in the following sections.

Defining Display Options

To define the display options for code information, use the **Options** tab of the **Code Display Preferences** dialog box:

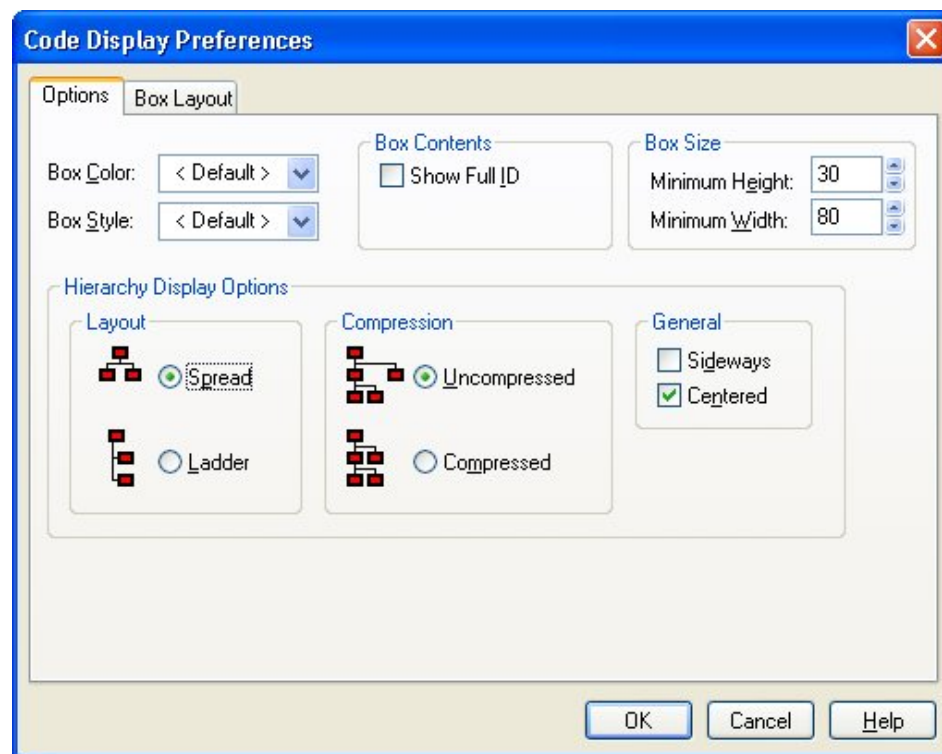

You can use this dialog box to specify the following options for displaying code information:

- **Box Color** — The color used to draw the code boxes.
- **Box Style** — The style used to display the code boxes. Open Plan allows you to choose a style from a list displayed when you enter the field.
- **Box Contents** You can display the entire code ID or just the local portion of each ID.
- **Minimum Height**— You can set the minimum height for the boxes.
- **Minimum Width** — You can set the minimum width for the boxes.
- **Spread/Ladder** — You can display the lowest level of the coding hierarchy in a “ladder” format to conserve horizontal space.

- **Compressed/Uncompressed** — You can display the coding hierarchy in a compressed mode in which individual codes belonging to one parent can be displayed beneath another parent.
- **Sideways** — You can display the coding hierarchy in a horizontal orientation.
- **Centered** — You can display the coding hierarchy centered in the workspace or left-justified. (If you are displaying the hierarchy using the **Sideways** option, turning off the **Centered** option results in the codes being aligned along the top of the workspace.)

To define code display options

1. Take one of the following actions:
 - On the **Tools** menu, click **Preferences**.
 - Right-click an empty area of the workspace, and click **Preferences** on the context menu.
2. On the **Options** tab of the **Code Display Preferences** dialog box, enter the information for the display options.
3. When the information is complete, click **OK** to return to the display.

Customizing Box Layout

If you are using the Professional edition of Open Plan, you can define which code fields are displayed when you view a code hierarchy. Boxes can contain as many as 50 different data items. You can also display blank lines in a box.

To customize the layout of code boxes, click the **Box Layout** tab on the **Code Display Preferences** dialog box:

The screenshot shows the **Code Display Preferences** dialog box with the **Box Layout** tab selected. The dialog contains a table with the following data:

Field	Line	Format
Code ID	1	1 Line
Code Description	2	Wrap Over 2 Lines

Annotations in the image point to the table and the **Change Order** buttons. The first annotation says: "Enter the data field, line number, and format for each item." The second annotation says: "Change the order of the items." The **Preview** window shows a box with the number "1" in the top line.

The preview area of the dialog box displays the current definition of the code boxes.



Note that this representation may differ slightly in size and aspect ratio from the actual display of boxes in the view.

Notice that Open Plan displays data items in the dialog box in order of line number. When you add, delete, or change data items, you must exit and return to the dialog box to display the items in the correct line sequence.

Open Plan displays items sharing the same line from left to right based on the order in which the items appear in the list. To move an item to a different position in the list, use the **Change Order** buttons.

You can customize the layout of the code box with the following settings:

- **Field** — You can select any code field for display.
- **Line** — For each field appearing in the code box, you must assign a line number. Code boxes can contain up to 20 lines, and each line can display one or more fields. If you assign multiple fields to a single line, the order in which the fields are listed in the dialog box determines how Open Plan displays the fields in the box. To display a blank line in the code box, do not enter settings for those lines. For example, to display code boxes with a double-high blank line, use the following settings:

Field	Line	Format
Code	1	1 Line
Code Description	4	1 Line

This results in the following code box:

E & D
Engineering

- **Format** — This setting has the following options to control the display of the data in the box:
 - 1 Line
 - Wrap Over 2 lines
 - Wrap Over 3 lines
 - Wrap Over 4 lines
- **Suppress Box Lines** — Selecting this option hides the display of lines within the code boxes.

To customize the code box layout

1. Take one of the following actions:
 - On the **Tools** menu, click **Preferences**.

- Right-click an empty area within the workspace, and click **Preferences** on the context menu.
2. On the **Code Display Preferences** dialog box, click the **Box Layout** tab.
 3. Enter the information for each data item.
To change the order of the items, select any cell in a row, and click one of the **Change Order** buttons.
To delete an item from the list, select any cell in the row, and press the **Delete** key.
 4. When your changes are complete, click **OK** to return to the view.

Using the Zoom Out and Zoom In Commands

Open Plan provides a **Zoom Out** and **Zoom In** command for showing code structures that cannot be displayed on a single screen.

If you select **Zoom Out** from the normal display mode, Open Plan applies a reduced display mode to the window where the code boxes are reduced so that all the codes in the structure are visible:

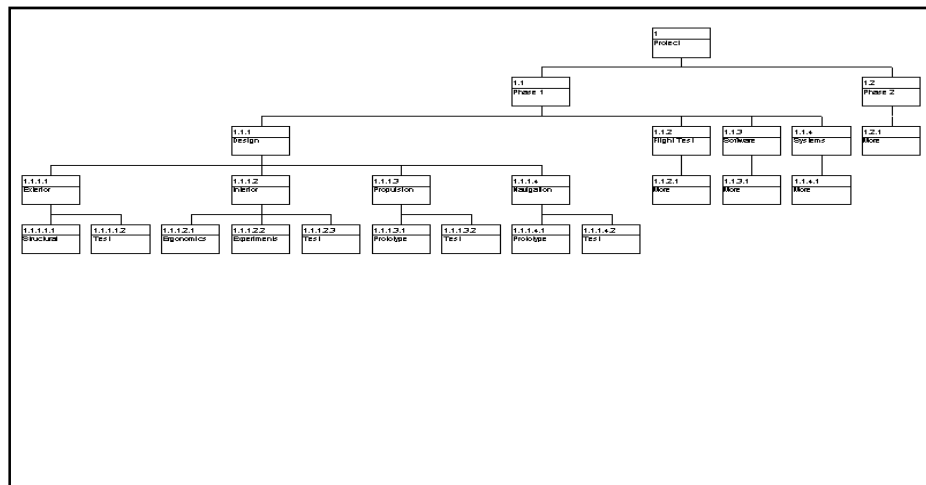

In this mode you can continue to work with the codes as though you were in the normal display mode.



If the entire code structure can be displayed at once, the **Zoom Out** command is not available.

In order to return to the normal display mode, Open Plan provides a **Zoom In** command. When the display mode has been reduced, the **Zoom In** command becomes enabled.

To zoom out from the normal display mode

1. Take one of the following actions:
 - On the **View** menu, click **Zoom Out**.
 - Right-click an empty area of the window, and click **Zoom Out** on the context menu.



Zoom Out button

- On the toolbar, click the **Zoom Out** button.

To zoom in from a reduced display mode

1. Take one of the following actions:
 - On the **View** menu, click **Zoom In**.
 - Right-click an empty area of the window, and click **Zoom In** on the context menu.
 - On the toolbar, click the **Zoom In** button .



Zoom In button

Entering Code Assignments

Depending on the number of code files you have assigned to the project or resource file, Open Plan allows you to enter one or more code assignments for the project, activities, or resources.

Project Code Assignments

To enter code assignments for a project, display the **Project Properties** dialog box for the project, and click the **Codes** tab:

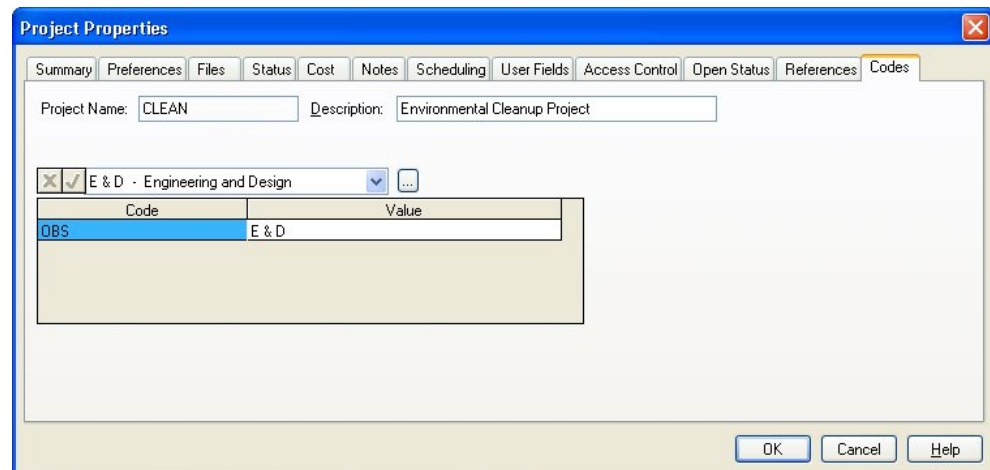

Clicking the **ellipsis** to the right of the edit field displays the **Assign Code** dialog box that you can use to quickly select the appropriate code to assign.

To enter a code assignment using the Project Properties dialog box

1. Display the **Project Properties** dialog box by taking one of the following actions:
 - Select the project folder, and click **Properties** on the **Project** menu.
 - Right-click the project folder, and click **Properties** on the context menu.
2. Click the **Codes** tab.
3. Enter the information for the code assignment, and click **OK**.

Activity Code Assignments

To enter code assignments for an activity, display the **Activity Details** dialog box for the selected activity, and click the **Codes** tab:

Activity Details [CLEAN]

General Relationships Resources **Codes** Advanced Risk User Fields Notes

ID: 1.01.01 Status: Planned
 Desc.: Requirements Coordination & Planning Duration: 30d

RES - Research

Code	Value
OBS	RES
WBS	1.2.1.3

Close Undo Apply New Progress... Help

Clicking the **ellipsis** to the right of the edit field displays the **Select Code** dialog box that you can use to quickly select the appropriate code to assign.

To enter a code assignment using the Activity Details dialog box

1. In an activity view, display the **Activity Details** dialog box using for the activity to which you want to enter an assignment.
2. Click the **Codes** tab.
3. Enter the information for the code assignment, and click **OK**.

Resource Code Assignments

To enter code assignments for a resource, display the **Resource Details** dialog box for the selected resource, and click the **Code** tab:

The screenshot shows the 'Resource Details [CLEANRES]' dialog box with the 'Code' tab selected. The 'ID' field contains 'RES.EQUIP' and the 'Desc' field contains 'Equipment'. Below these fields is a table with two columns: 'Code' and 'Value'. The table contains the following entries:

Code	Value
DBS	
Section	
OBS	
WBS	
WBS	

At the bottom of the dialog box are navigation buttons (Home, Back, Forward, End) and functional buttons: Close, Undo, Apply, New, and Help.

Clicking the **ellipsis** to the right of the edit field displays the **Select Code** dialog box that you can use to quickly select the appropriate code to assign.

To enter a code assignment using the Resource Details dialog box

1. In the resource view, display the **Resource Details** dialog box for the resource to which you want to enter an assignment.
2. Click the **Code** tab.
3. Enter the information for the code assignment, and click **OK**.

Using an Activity Spreadsheet View

It is also possible to enter information about code assignments using an activity spreadsheet view. In this type of view, code assignment information is displayed in a tabular format:

Activity ID	Activity Desc.	Duration	Activity Type	Early Dates	Late Dates	Total Float	Calendar ID
1	Environmental Management System	572d	Subproject	02Jan03 15Mar05	08Jan03 15Mar05	0	1
1.01	Requirements Development	54d	Subproject	02Jan03 18Mar03	08Jan03 24Mar03	4d	1
1.01.01	Requirements Coordination & Planning	30d	ASAP	05Feb03 18Mar03	11Feb03 24Mar03	4d	1
1.01.02	Site Management	24d	ASAP	02Jan03 04Feb03	08Jan03 10Feb03	4d	1
1.02	Coordination Planning	29d	Subproject	19Mar03 28Apr03	25Mar03 02May03	4d	1
1.02.01	Engineering Field Testing	13d	ASAP	19Mar03 04Apr03	25Mar03 10Apr03	4d	1
1.02.02	System Integration	16d	ASAP	07Apr03 28Apr03	11Apr03 02May03	4d	1
1.03	Environmental Package System	131d	Subproject	29Apr03 28Oct03	05May03 03Nov03	4d	1
1.03.01	Chemical & Mineralogical Survey	3d	ASAP	29Apr03 01May03	05May03 07May03	4d	1
1.03.02	Geochemical Properties	50d	ASAP	02May03 10Jul03	08May03 16Jul03	4d	1
1.03.03	Spent Fuel Modeling	50d	ASAP	02May03 10Jul03	03Jul03 10Sep03	44d	1
1.03.04	Spent Fuel Tests	38d	ASAP	11Jul03 02Sep03	11Sep03 03Nov03	44d	1
1.03.05	Research Integration Model	10d	ASAP	11Jul03 24Jul03	17Jul03 30Jul03	4d	1

You can use an activity spreadsheet view to add or update any information about code assignments.



For information about adding or modifying columns in a spreadsheet view, refer to Chapter 20, "Spreadsheet Views."

12

Hierarchical Projects

➤ Overview	289
➤ Setting Up Project Hierarchies	290
➤ Subprojects in Network Views	293
➤ Subprojects in Spreadsheet Views	297
➤ Working with External Subprojects	301
➤ Reporting Hammocks.....	304

Overview

The multi-project capabilities of Open Plan allow planners to create hierarchies of project information. With project hierarchies, you can break large projects down into multiple subprojects, which can serve as high-level cost and schedule summarizations for lower-level detail. Organizations can also use these features to roll up smaller projects into a single master project in order to perform scheduling and resource planning functions at a more comprehensive level.

This chapter contains a number of discussions related to project hierarchies in Open Plan, including setting up a project hierarchy and working with hierarchical projects in different views.

The chapter concludes with a discussion of reporting hammocks, a traditional feature for rolling up project information.

Setting Up Project Hierarchies

To define a hierarchy of project information, Open Plan allows you to designate any activity as a “parent” of lower-level “child” activities. Children of a parent activity can, in turn, have child activities of their own. Thus, there are no limits on the number of hierarchical levels you can define in a project. Nor is there a requirement that a single top-level activity exist for each project.

When defining hierarchies of project information, both the Professional and the Desktop editions of Open Plan allow you to set up internal subprojects, which represent child activities belonging to the same project as the parent. Users of the Professional edition of Open Plan can also set up external subprojects, which represent activities belonging to a different project. Both internal and external subprojects, however, function in the same way, and the same master project can contain both types of subprojects.

Periods in the activity ID indicate the hierarchical relationships between activities. For example, the subproject SUB1 might have child activities named SUB1.01, SUB1.02, and so on. Children of SUB1.01 might be named SUB1.01.01, SUB1.01.02, and so on. Depending on the context, you may have to identify an activity by using its complete ID, or you may need to enter only the local portion of the code.

Activities that you designate as subprojects are identical to standard activities with the following exceptions:

- The duration of a subproject is dependent on its child activities. You cannot enter a duration for an activity that has been converted to a subproject.
- Resource requirements assigned to the subproject level do not result in delaying the subproject during resource scheduling.
- Once you have designated an activity as a subproject, you cannot change the activity type unless you remove all the child activities belonging to that subproject.
- When you copy a subproject, you copy all child activities belonging to that subproject as well.
- When you delete a subproject, you delete all child activities belonging to that subproject as well.

Like standard activities, you can assign target start and finish dates to subproject activities. It is also possible to define relationships between subprojects or between a subproject and an activity within another subproject.

The assignment of target dates and relationships to subprojects can have important implications when time-analyzing a network.



For more information, refer to Chapter 8, “Time Analysis Calculations,” in the *Deltek Open Plan Developer’s Guide*.

Defining Internal Subprojects

To convert an existing activity to an internal subproject, change the **Type** setting to **Subproject** on the **General** tab of the **Activity Details** dialog box:

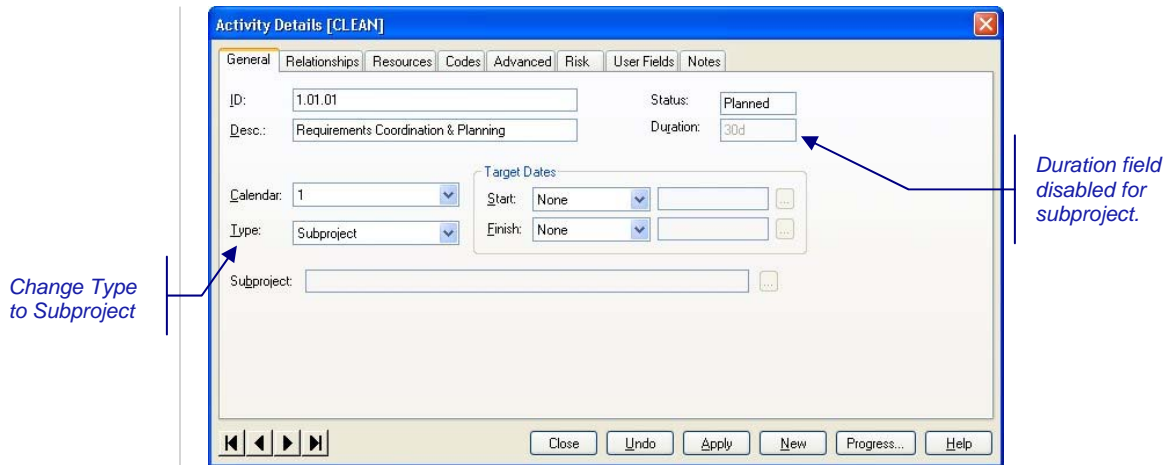

 Notice that you cannot enter the duration of an activity that has been converted to a subproject.

To convert an activity to an internal subproject

1. Display the **Activity Details** dialog box for the activity to be converted, and click the **General** tab.
2. From the **Type** list, select **Subproject**.
3. Click **Close**.

Defining External Subprojects

If you are using the Professional edition of Open Plan, you can designate activities as external subprojects. To convert an activity to an external subproject, you must change the **Type** setting to **External Subproject** and indicate the project file for the **Sub-Project** setting:

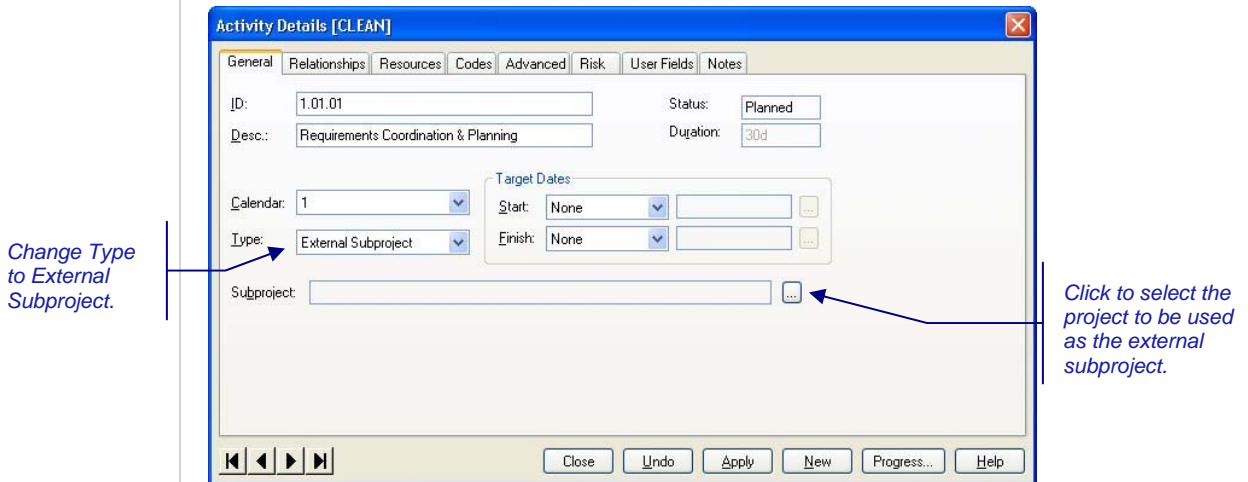

After clicking **Apply**, you can then click the **ellipsis** to the right of the **Sub-Project** field. Open Plan responds by displaying the following dialog box:

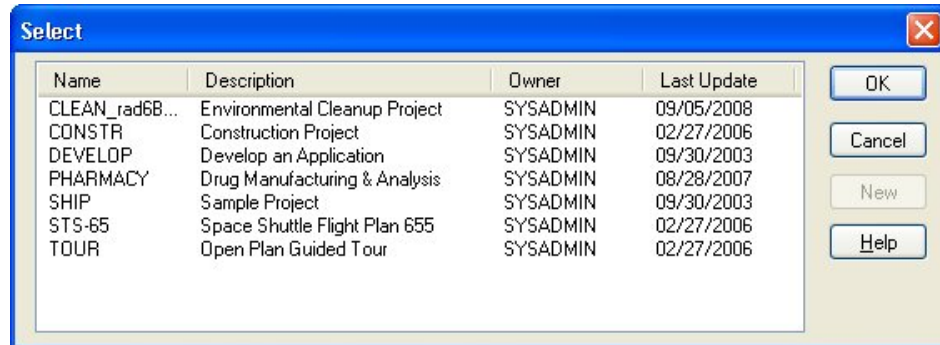

You can use this dialog box to select the name of the project to become the external subproject.

The Professional edition of Open Plan automatically saves any external subprojects as internal subprojects when you use the **Save As** command to save project information. This automatic conversion also occurs the first time you save a new project. As a result, to set up a project hierarchy that includes external subprojects, you must first create and save the master project before converting any activities into external subprojects.



For information on creating a multiproject project using the **New File Wizard**, refer to Chapter 4, "Creating a New File."

To convert an activity to an external subproject

1. Display the **Activity Details** dialog box for the activity to be converted, and click the **General** tab.
2. From the **Type** list, select **External Subproject**.
3. Click the **ellipsis** to the right of the **Sub-Project** field.
4. From the **Select** dialog box, select the name of the project to be used as the external subproject, and click **OK** to return to the **General** tab.
5. When the information for the activity is complete, click **OK**.

Subprojects in Network Views

Network views include the following features related to hierarchical projects:

- Displaying project hierarchies
- Adding child activities
- Cutting and pasting activities in different subprojects.

The following sections discuss each of these features in turn.

Displaying Project Hierarchies

Open Plan provides two sets of commands for displaying different hierarchical levels of a project that includes internal or external subprojects and navigating between them:

- The **Expand**, **Expand All**, **Collapse Subproject**, and **Collapse All** commands allow you to expand and collapse the display of multiple hierarchical levels of a project within a single view.
- The **Go To Subproject**, **Go To Parent**, and **Go To Top Level** commands allow you to move through the different hierarchical levels by either “drilling down” into a subproject or moving up to the parent or top level.

These commands are available for use with both internal and external subprojects.

When you expand a subproject in a network view, Open Plan can display the child activities in a frame that includes the subproject ID:

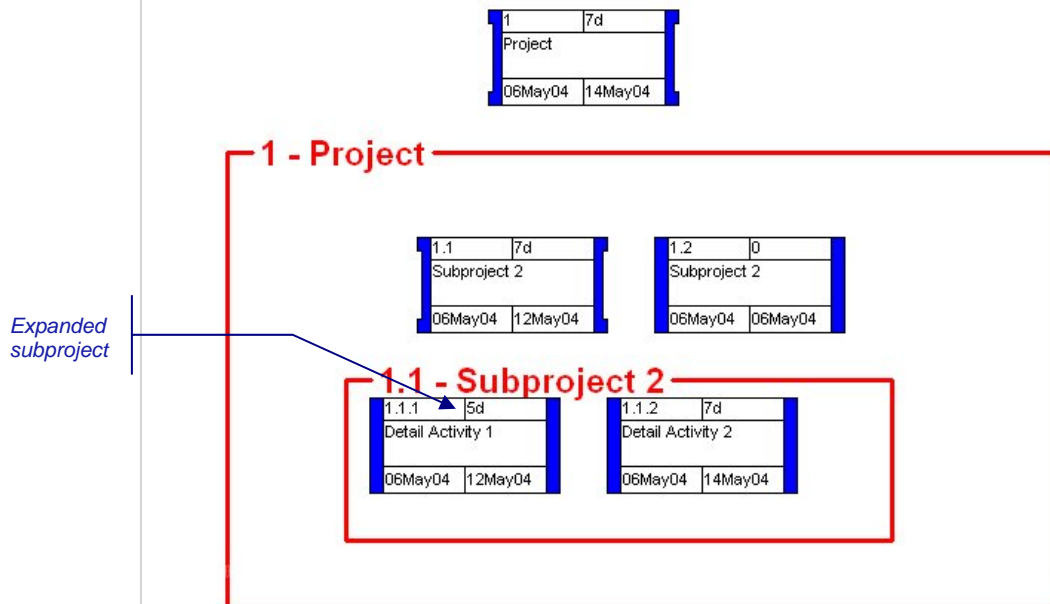

Once you expand a subproject, you can edit the displayed activities and relationships. You can also create relationships between activities both within the same subproject and in different subprojects. You cannot, however, add new activities or relationships to the expanded subproject. Instead, you must drill down to the appropriate level using the **Go To Subproject** command to add new activities and relationships.



For an example of how to display multiple hierarchical levels using the **Expand** and **Go To Subproject** commands, refer to Chapter 19, “Network Views.”

To drill down into a subproject

1. Select the parent of the subproject you want to drill down to.
2. Take one of the following actions:
 - On the **View** menu, click **Go To Subproject**.
 - Right-click the activity, and click **Go To Subproject** on the context menu.
 - On the toolbar, click the **Drill down** button.



Drill down button

To go to the parent activity of the current level

1. Take one of the following actions:
 - On the **View** menu, click **Go To Parent**.
 - Right-click an empty area of the view, and click **Go To Parent** on the context menu.
 - On the toolbar, click the **Drill up** button.



Drill up button

To go to the top level of the project

1. Take one of the following actions:
 - On the **View** menu, click **Go To Top Level**.
 - Right-click an empty area of the view, and click **Go To Top Level** on the context menu.

To expand a subproject

1. Select the subproject you want to expand.
2. Take one of the following actions:
 - On the **View** menu, click **Expand**.
 - Right-click the activity, and click **Expand** on the context menu.
 - On the toolbar, click the **Expand** button.



Expand button

To expand all subprojects

1. Take one of the following actions:
 - On the **View** menu, click **Expand All**.
 - On the toolbar, click the **Expand All** button.



Expand All button

To collapse a subproject

1. Right-click the subproject area, and click **Collapse Subproject** on the context menu.

To collapse all subprojects

1. Take one of the following actions:

 Collapse All button

- On the **View** menu, click **Collapse All**.
- On the toolbar, click the **Collapse All** button.

Adding Child Activities

In a network view, use the **Add Child** command to add child activities to a parent. If you use this command for a standard activity, Open Plan automatically converts the activity type to **Subproject** before allowing you to add a child. This means that Open Plan will ignore any durations for the parent activity for subsequent time analysis.

When adding a child to a parent, you enter only the local portion of the activity ID. Once you have completed entering information about the child activity, Open Plan goes to the appropriate subproject level so that you can continue entering children at that level. To return to the parent activity after entering a child, you must use the **Go To Parent** command.



For an external subproject, the **Add Child** command is available only if the external subproject is open.

To add a child activity

1. Take one of the following actions:
 - Select the parent activity, and click **Add Child** on the **Edit** menu.
 - Right-click the activity, and click **Add Child** on the context menu.
2. Enter the information for the child activity.



Note that Open Plan allows you to enter only the local portion of the activity ID.

3. To return to the parent activity, take one of the following actions:
 - On the **View** menu, click **Go To Parent**.
 - Right-click an empty area of the view, and click **Go To Parent** on the context menu.

Moving Activities Between Subprojects

To move activities from one subproject to another, use the **Cut** and **Paste** commands. You can also use the **Copy** and **Paste** commands to place copies of activities into different subprojects. When you move or copy activities between subprojects, Open Plan automatically adds the appropriate prefix to the local portion of the activity ID to indicate the new parent. If Open Plan detects the presence of existing activities with potentially duplicate IDs, the local portion of the new activity IDs are renumbered as well.



You can also move an activity to a different subproject by changing the parent portion of the activity ID. When you move an activity using this technique, Open Plan retains all the relationships for the activity.



Cut button



Paste button



Paste cursor

To move activities to a subproject

1. Select the activity or activities you want to move.
 2. Take one of the following actions:
 - On the **Edit** menu, click **Cut**.
 - Right-click the activity, and click **Cut Activities** on the context menu.
 - On the toolbar, click the **Cut** button.
 3. Go to the appropriate subproject in the project.
 4. Take one of the following actions:
 - On the **Edit** menu, click **Paste**.
 - Right-click an empty area of the view, and click **Paste** on the context menu.
 - On the toolbar, click the **Paste** button.

The cursor shape changes to a paste tool.
 5. Click the position where you want to paste the activities.
- Open Plan automatically rennumbers the moved activities, including the local portion of the ID if necessary, to avoid duplicating existing activity IDs.

To copy activities to a subproject

1. Select the activity or activities you want to copy.
 2. Take one of the following actions:
 - On the **Edit** menu, click **Copy**.
 - Right-click the activity, and click **Copy Activities** on the context menu.
 - On the toolbar, click the **Copy** button.
 3. Go to the appropriate subproject in the project.
 4. Take one of the following actions:
 - On the **Edit** menu, click **Paste**.
 - Right-click an empty area of the view, and click **Paste** on the context menu.
 - On the toolbar, click the **Paste ..**

The cursor shape changes to a paste tool.
 5. Click the position where you want to paste the activities.
- Open Plan automatically rennumbers the copied activities, including the local portion of the ID if necessary, to avoid duplicating existing activity IDs.



Copy button



Paste button



Paste cursor

Subprojects in Spreadsheet Views

In a spreadsheet view (or in the spreadsheet pane of a barchart view), you can convert an activity into an internal subproject simply by adding an activity with an ID that indicates that it is a child of the subproject. For example, if the project contains an activity ACT01, adding the activity ACT01.1 to the project automatically converts ACT01 into an internal subproject.

To control the display of subprojects and their children, you can use the outlining feature of spreadsheet views to display project information hierarchically:

Click to expand or collapse the subproject.

	Activity ID	Activity Desc.	Duration	Total Float	Early Start	Early Finish
-	1	Environmental Management System	572d	0	02Jan03	15Mar05
-	1.01	Requirements Development	54d	4d	02Jan03	18Mar03
	1.01.01	Requirements Coordination & Planning	30d	4d	05Feb03	18Mar03
	1.01.02	Site Management	24d	4d	02Jan03	04Feb03
-	1.02	Coordination Planning	29d	4d	19Mar03	28Apr03
	1.02.01	Engineering Field Testing	13d	4d	19Mar03	04Apr03
	1.02.02	System Integration	16d	4d	07Apr03	28Apr03
-	1.03	Environmental Package System	131d	4d	29Apr03	28Oct03
	1.03.01	Chemical & Mineralogical Survey	3d	4d	29Apr03	01May03
	1.03.02	Geochemical Properties	50d	4d	02May03	10Jul03
	1.03.03	Spent Fuel Modeling	50d	44d	02May03	10Jul03
	1.03.04	Spent Fuel Tests	38d	44d	11Jul03	02Sep03
	1.03.05	Research Integration Model	10d	4d	11Jul03	24Jul03
	1.03.06	Thermodynamic Data Research	22d	4d	25Jul03	25Aug03
	1.03.07	Design, Fabrication Prototype	46d	4d	26Aug03	28Oct03
-	1.04	Environmental Package Design Specifications	92d	4d	29Oct03	08Mar04
	1.04.01	Environmental Package Design Construction	60d	4d	29Oct03	22Jan04
	1.04.02	Container Fabrication Development	32d	4d	23Jan04	08Mar04
-	1.05	Site Investigations	50d	4d	09Mar04	17May04
	1.05.01	Site Investigation Integration	2d	4d	09Mar04	10Mar04

In a spreadsheet view using outlining, subprojects are displayed with a **plus (+)** sign or a **minus (-)** sign on the **outlining** button to the left of the row. If the **outlining** button displays a plus sign, you can expand the subproject to see more detailed information. If the **outlining** button displays a minus sign, the subproject is already completely expanded — clicking the **outlining** button collapses the subproject in this case.



For information about turning outlining on or off in a spreadsheet view, refer to Chapter 20, "Spreadsheet Views."

To add a child activity

1. Create an activity with an ID that indicates the desired parent/child relationship.

For example, to add a child to activity ACT01, create activities ACT01.01, ACT01.02, and so on.



When you add a child in a spreadsheet view, Open Plan automatically converts the parent activity into an internal subproject.

To expand a collapsed subproject

1. Take one of the following actions:
 - Click the **outlining** button next to the row.
 - Select the subproject, and click **Expand** on the **View** menu.
 - Select the subproject, and click the **Expand** button on the toolbar.



Expand button

To collapse an expanded subproject

1. Take one of the following actions:
 - Click the **outlining** button next to the row.
 - Select the subproject, and click **Collapse** on the **View** menu.
 - Select the subproject, and click the **Collapse** button on the toolbar.



Collapse button

To expand all subprojects

1. Take one of the following actions:
 - On the **View** menu, click **Expand All**.
 - On the toolbar, click the **Expand All** button.



Expand All button

To collapse all subprojects

1. Take one of the following actions:
 - On the **View** menu, click **Collapse All**.
 - On the toolbar, click the **Collapse All** button.



Collapse All button

Indent

The indent feature allows you to quickly renumber hierarchical IDs while in a spreadsheet view. When you use this feature, Open Plan renumbers the relevant ID according to the rules for automatic numbering.



For more information on automatic numbering in spreadsheets, refer to Chapter 20, "Spreadsheet Views."

By indenting an ID, Open Plan makes it into a child of the previous activity in the hierarchy and changes that previous activity into a subproject if it is not already one. For example, assume you have a project with the following hierarchy:

10
20
30
40
50

Indenting ID 20 instructs Open Plan to make it a child of ID 10 and to make ID 10 a subproject. Therefore, the following hierarchy results:

```

10
  10.20
30
40
50

```

Indenting is not available when subsectioning is in effect or in multi-table views.



Indenting may cause loops in the network logic. You can detect these loops by running time analysis and examining the log generated.

To indent a hierarchical ID

1. Display a spreadsheet containing the ID you want to indent. For example, you might display one of the following views:
 - Activity spreadsheet
 - Resource assignment spreadsheet
 - Code assignment spreadsheet
2. Select the ID that you want to indent.
3. Take one of the following actions:
 - On the **Edit** menu, click **Indent**.
 - On the toolbar, click the **Indent** button.



Indent button

Outdent

The outdent feature allows you to promote an ID in a hierarchy to the level of its parent. In assigning an ID to an outdented element, Open Plan follows the rules for automatic numbering.



For more information on automatic numbering in spreadsheets, refer to Chapter 20, "Spreadsheet Views."

For example, assume you have a project with the following hierarchy:

```

10
  10.1
30
40
50

```

If ID 10.1 were to be outdented, the system would assign it ID 11. Notice that although the remaining IDs in the hierarchy are numbered in increments of 10, Open Plan assigns the outdented activity the first available ID number.



Outdent is not available when subsectioning is in effect or in multi-table views.

To outdent an activity, resource, or code ID

1. Display a spreadsheet containing the ID you want to outdent. For example, you might display one of the following tables in the spreadsheet:
 - Activity
 - Resource assignment
 - Code assignment



For more information on changing the table in a spreadsheet, refer to Chapter 20, "Spreadsheet Views."

2. Select the ID that you want to outdent.
3. Take one of the following actions:
 - On the **Edit** menu, click **Outdent**.
 - On the toolbar, click the **Outdent** button.



Outdent button

Working with External Subprojects

If you are using hierarchical projects that include external subprojects, you may want to consider issues related to the following:

- Opening external subprojects
- Auxiliary data (resource, calendar, and code) files
- Converting external subprojects to internal subprojects
- Displaying foreign activities

Of these topics, the first three apply only to the Professional edition of Open Plan since you cannot define or open an external subproject in the Desktop edition of Open Plan.

Opening External Subprojects

Each time you open a project containing external subprojects in the Professional edition, Open Plan displays a hierarchical list of external subprojects (and externals embedded within the top layer of externals). In the **Open External Subprojects** dialog box displayed below, all projects are available and selected to be opened. If you want to open only certain subprojects, deselect the project(s) you do not want to open. You may also use the **Select All** or **Deselect All** buttons on the right.

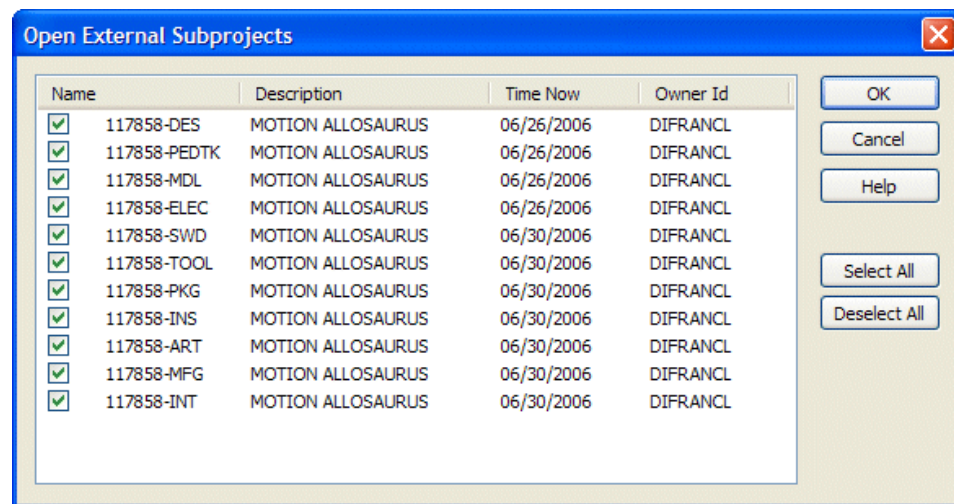

All externals opened under a master project must be opened in the same mode (exclusive, shared, read-only) as the master project. If the current user has opened one of the externals independently of the master project, the list will show a red "X" before the name of the external, indicating that it cannot be opened as part of the master. If another user has opened one or more of the externals in a mode that will prevent the current user from opening the external in the same mode as the master, the list will show a warning sign before the name of the external, indicating that it should be deselected unless the other user corrects the conflict before the current user continues. The graphic below displays a project that has been opened in exclusive mode. Placing your cursor over one of the "flagged" external subprojects that is open displays the User ID, Machine ID, Open Mode, Opened On, and User Name (Phone) of the person who opened the project.

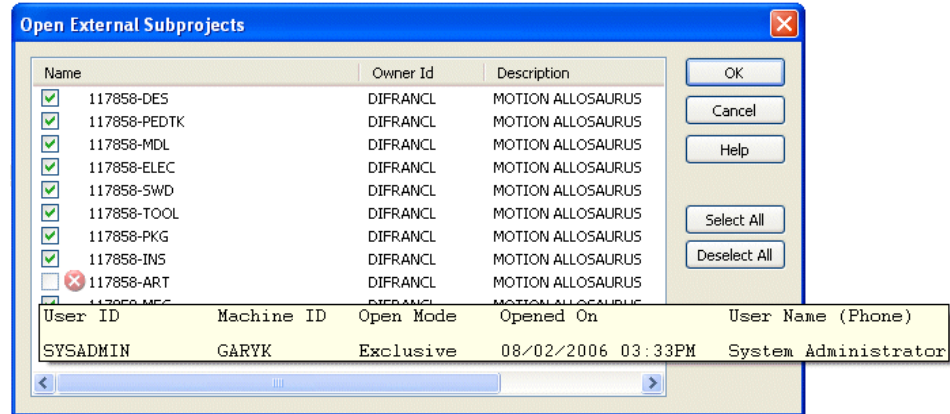

In addition, each column in the **Open External Subprojects** dialog box (Name, Owner ID, and Description) can be sorted in ascending or descending order by clicking the appropriate column heading.

Even if you did not open an external subproject at the time you opened the master project, the Professional edition of Open Plan allows you to open the appropriate subproject later by using **Expand** or **Expand All** in the spreadsheet, barchart, or network views or by using **Go To Subproject** in the network view.

When opening an external subproject, the Professional edition of Open Plan attempts to use the same access mode as used to open the master project.



For information about multi-user access to project information, refer to Chapter 24, "System Utilities."

If an external subproject is open, you can display and update the information for the activities in the external subproject just as if they belonged to the master project. For example, if you perform time analysis on the master project, the Professional edition of Open Plan updates the early and late dates of the external subproject activities as well.

For closed external subprojects, however, Open Plan has access only to the summarized information stored on the subproject record. If you perform time analysis on a master project that includes a closed external subproject, for example, the early and late dates of a subproject can influence the dates calculated for the master project. On the other hand, the operation does not result in the dates for the individual activities in the closed subproject being recalculated.



For a description of the effect of external subprojects on time analysis calculations, refer to Chapter 8, "Time Analysis Calculations," in the *Deltek Open Plan Developer's Guide*.

External Projects and Auxiliary Data Files

When you open a hierarchical project that contains external subprojects in the Professional edition of Open Plan, the program checks that the master project has the same auxiliary data files attached to the various external subprojects. For example, the master project must have the same code slots populated as those in the external subprojects, but the code slots can be different as long as the projects have the same structure (for example, fixed format).

Converting External Projects

If you are using the Professional edition of Open Plan, you can convert an external subproject into an internal subproject by using the **Save As** command to save the master project. This feature allows you to build large projects quickly out of existing subprojects and applies to all external subprojects that are open at the time you invoke the command.

Displaying Foreign Activities

Because Open Plan allows you to define relationships between activities in different subprojects as well as relationships that cross hierarchical levels, it is possible for a relationship between an activity (or subproject) in the master project and an activity in an external subproject to exist. This situation can occur in either the Professional or the Desktop edition of Open Plan.

To represent such a relationship when opening an external subproject outside of the context of a master project (or when opening an external subproject that has a relationship to an activity in another subproject), Open Plan displays a dimmed “foreign activity” in the network view. Open Plan displays the top-level foreign subproject only, any external subproject beneath the master is shown as a foreign activity.

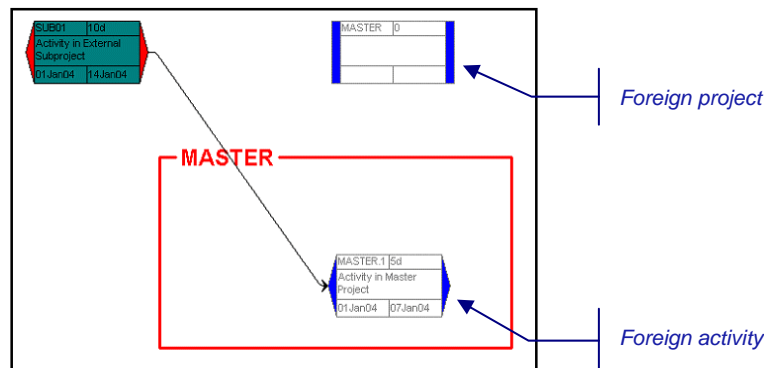

You cannot update the information for a foreign activity or any of its parents. You can delete foreign activities appearing in a subproject, but this does not delete the relationship stored in the master project.



For a description of the effect of foreign activities on time analysis calculations, refer to Chapter 8, “Time Analysis Calculations,” in the *Deltek Open Plan Developer’s Guide*.

Reporting Hammocks

A hammock is an activity that does not influence the time analysis of a project but provides a means for reporting on the start and finish of a group of related activities. Open Plan calculates the duration of a hammock based on the early start date of the earliest activity serving as the hammock start and the early finish date of the latest activity serving as the hammock finish, as in this example:

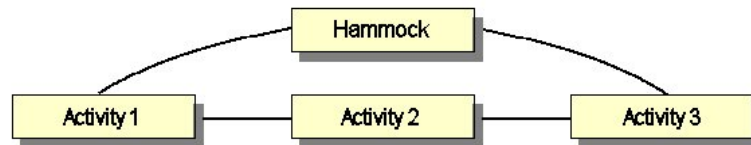

To set up a hammock in Open Plan, you must first create an activity and define it as a hammock. Once you have created the hammock activity, you must define at least one relationship between the start of the hammock and the activity (or activities) that represent the beginning of the hammock. You can then define relationships between the finish of the hammock and the activity (or activities) that represent the end of the hammock.

Like subprojects, the durations of hammock activities are calculated each time the network is time-analyzed. In addition, resource requirements assigned to hammocks have no effect on resource scheduling calculations other than restricting resource availabilities for other activities.

Open Plan allows multiple starts and finishes to a hammock, and some or all of these can themselves be hammock activities. You cannot, however, define a hammock as a predecessor to a non-hammock. This restriction means that hammocks can never have any impact on the schedules of non-hammock activities.

Although hammocks in Open Plan have many flexible features (you can, for example, include hammocks within other hammocks), their use is limited by the fact that it may be difficult to determine exactly which activities are included in a given hammock. They are also limited by the fact that they do not summarize costs or resources.

13

Time Analysis

➤ Overview	307
➤ What is Time Analysis?	308
➤ Time Analysis Operations	311

Overview

The ability to schedule a network that contains thousands (or tens of thousands) of activities is the hallmark of all high-end project management systems. The time analysis calculations performed by Open Plan are specifically designed to schedule large networks with speed, accuracy, and efficiency. A number of processing options allow you to modify the results of the standard calculations in order to model specific situations.

This chapter begins with a brief introduction to time analysis features followed by a description of how to perform time analysis in Open Plan.



For a complete discussion of the calculations performed by time analysis, refer to Chapter 8, "Time Analysis Calculations," in the *Deltek Open Plan Developer's Guide*.

What is Time Analysis?

Time analysis is the process of determining the overall schedule of a project by calculating start and finish dates for each activity in the project. Time analysis calculations are based solely on the Time Now date, the duration of the activities, and the logical relationships between them. Unlike resource scheduling, therefore, time analysis does not take into consideration the availability or non-availability of resources required by activities.

When you perform time analysis in Open Plan, the following data is calculated:

- Early and late dates
- Float
- Activity information
- Subproject information
- Project information

Each of these types of data is discussed in the following sections.

Early and Late Dates

Time analysis calculates four dates for each activity in a project: early start, early finish, late start, and late finish.

- **Early Start** — The earliest date on which an activity can start
- **Early Finish** — The earliest date on which an activity can finish
- **Late Start** — The latest date on which an activity must start if the project completion date and target dates are to be met
- **Late Finish** — The latest date on which an activity must be completed if the project completion date and any finish target dates are to be met

Open Plan calculates the early start and early finish dates in what is known as the forward pass through the project data. During the forward pass, Open Plan starts at the Time Now date and moves forward through the project in the order determined by the relationships between the activities. As it moves through the project, Open Plan adds the durations of the individual activities as well as any lags on the relationship between them.

Open Plan calculates the late start and late finish dates in what is known as the backward pass. During the backward pass, Open Plan starts at the project finish date and considers the relationships between activities to move through the project in reverse order. As it moves through the project in reverse, Open Plan subtracts the durations of the individual activities and considers any lags between them.

Float Calculations

In general, float is the number of time periods by which an activity can be delayed without affecting other activities in a project. Open Plan calculates two principal float values during time analysis: total float and free float.

- **Total float** — Total float is the difference between the early and late start dates measured in working periods of the activity calendar. Total float can be either positive or negative. For example, assume a 7-day work week. If an activity has an early start date of July 1 and a late start date of July 10, that activity

would have a total float of 9 days. On the other hand, if the activity has an early start date of July 10 and a late start date of July 1, the activity would have a total float of -9 days. If the target date is not set, no floats will be negative. If all activities in a project use the same calendar and if target dates have not been set, there is always at least one path through the project with exactly zero total float. This is known as the critical path.



There can be more than one critical path.

- **Free float** — Free float is the maximum amount by which an activity can be delayed beyond its early dates without delaying any successor activity beyond its early dates. If target finish dates have not been set, free float is always less than or equal to total float. Free float can never be negative.

Time analysis also calculates two float values related to relationships (relationship total float and relationship free float) and two float values that have special relevance to discontinuous activities and subprojects (finish total float and finish free float).



For information about these calculations, refer to Chapter 8, "Time Analysis Calculations," in the *Deltek Open Plan Developer's Guide*.

Supplemental Activity Information

In addition to early dates, late dates, and float, the time analysis function in Open Plan provides the following information about each activity in the project:

- The computed remaining duration of the activity
- The computed status of the activity as follows:
 - **Planned**
 - **In-progress**
 - **Complete**
- A flag for the following activity types:
 - **Start activity** — an activity without predecessors
 - **Finish activity** — an activity without successors
 - **Isolated activity** — an activity without either predecessors or successors
 - **Start/finish activity** — a discontinuous activity that has successors only from its start and predecessors only from its finish
- One of the following indicators of activity criticality:
 - **Not critical**
 - **Critical** — total float less than or equal to zero
 - **Most critical** — total float equal to the smallest value for the entire project
 - **Controlling critical** — has float due to its own calendar but causes a successor to be critical
- **Out of Sequence (OUTOFSEQ)** — a flag to indicate if the activity has been progressed out of sequence

Subproject Information

Open Plan calculates the following information for each subproject (both internal and external) during time analysis:

- The duration of the subproject
- Early and late dates
- The remaining duration for the subproject if it's activities are in progress

Project Information

Each time you perform a time analysis, Open Plan calculates the following information for the project:

- The computed status of the project as follows:
 - Planned
 - In-progress
 - Complete
- The latest early finish date in the project
- The latest late finish date in the project
- Percentage of the total project duration that is complete
- The minimum value for total float for any activity (or activities) in the project
- The number of in-progress activities
- The number of completed activities

Time Analysis Operations

Although you can perform time analysis at any time, typically you would do so when you have:

- Entered all the activities for a project
- Changed the logic of the project, for example:
 - You have added or deleted one or more activities and their relationships.
 - You have changed the target dates or durations of one or more activities.
 - You have changed the relationship between any two activities.
- Changed the calendars used by the project
- Changed Time Now
- Entered progress information for any activities in the project
- Changed the target start or finish date for the project

Open Plan provides three ways to perform time analysis on a project:

- The **Time Analysis** dialog box
- The **Time Analysis** button on the toolbar
- Automatic time analysis

Each time you perform time analysis using either the **Time Analysis** dialog box or the **Time Analysis** button, Open Plan creates a session log file that records any system or error messages issued during the operation. Open Plan saves the file (Opp_ta.log) and allows you to examine its contents at the conclusion of each session.

Included in each session log is a list of all start and finish activities in a project.



Time Analysis
button



Open Plan does not produce a session log file if you have enabled the automatic time analysis mode.

Using the Time Analysis Dialog Box

When you select a project and click **Time Analysis** on the **Project** menu, Open Plan displays a dialog box with two tabs: the **Options** tab and the **Advanced** tab.

The **Options** tab displays the basic settings for a time analysis session:

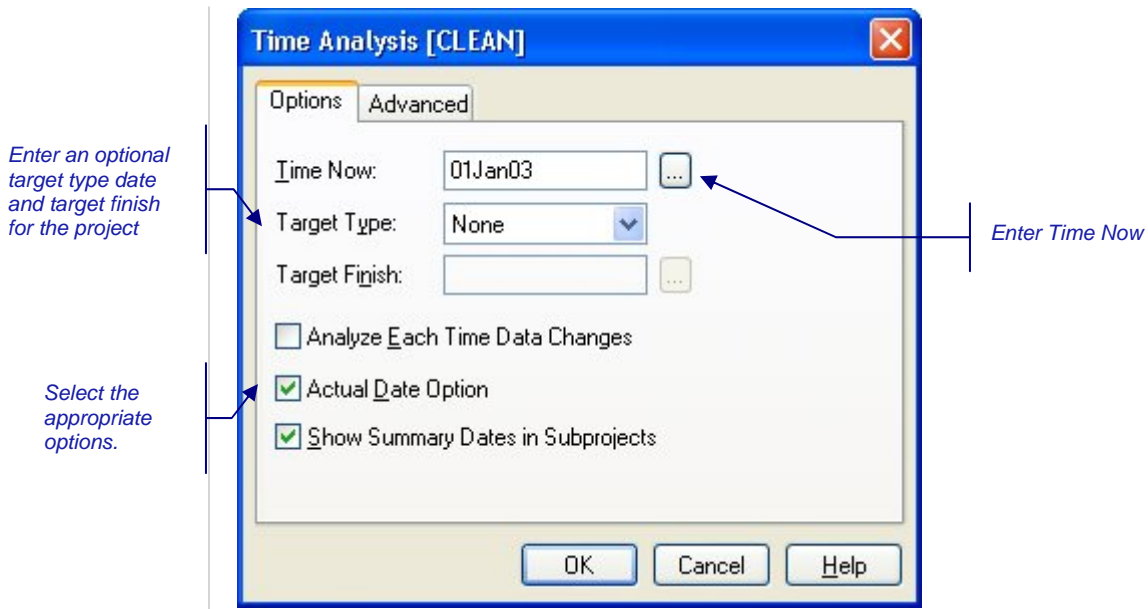

You can use this tab to enter the following settings:

- **Time Now** — If this is the first time you have time-analyzed the project, Open Plan requires you to enter a date for Time Now. Time Now is the current project status date, and Open Plan will not calculate any dates prior to this date. If the project is not yet underway, enter the planned project start date for Time Now. If the project has started and you have entered progress information for one or more activities, Time Now should be the latest date for which all progress information is correct.
- **Target Type** — If you enter a target start or target finish date for the project, you can define the target date as one of the following types:
 - Not earlier than
 - Not later than
 - On target
- **Target Finish** — You can enter an optional target finish date for the project. In general, however, you should not enter a target finish date for projects that have not been previously analyzed.

In addition to using the **Time Analysis** dialog box, you can enter Time Now and target dates and types using the **Status** tab of the **Project Properties** dialog box.



For a description of the **Status** tab, including an extended discussion of project target dates, refer to Chapter 5, “Project Properties.”

- **Analyze Each Time Data Changes** — This option enables automatic time analysis. If selected, Open Plan automatically calculates time analysis whenever you make a date-related change to the project.



If this option is selected, the **Time Analysis** button on the toolbar is not enabled.

- **Actual Date Option** — You can enable an option to have Open Plan substitute actual dates (where present) for the early and late dates generated by time analysis calculations. This option does not otherwise affect the calculations of time analysis. If you do not enable this option, the early dates calculated by time analysis relate only to the remaining portion of the activity.



For more information about this option, refer to Chapter 4, “The Open Plan Configuration Files,” in the *Deltek Open Plan Developer’s Guide*.

- **Show Summary Dates in Subprojects** — This option controls whether Open Plan should copy the dates calculated for the child activities into the record of the activity representing the subproject.
 - If selected, subproject activities display a summary of the dates calculated for their child activities. This is the default setting.
 - If not selected, subproject activities display the dates calculated for the subproject activity itself.

The **Advanced** tab of the **Time Analysis** dialog box displays settings that are seldom changed:

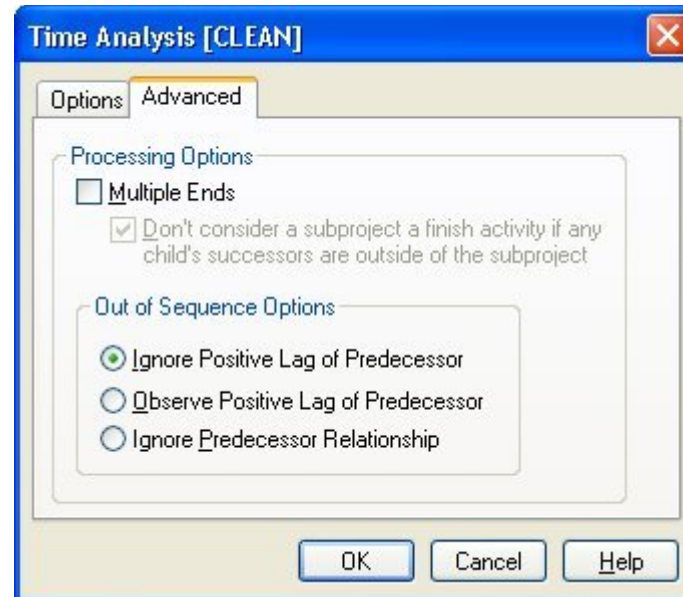

You can use this tab to enter the following settings:

- **Multiple Ends** — A final consideration arises if the multiple ends processing option has been specified. In that case, Open Plan treats each end activity as if the activity had a target finish equal to its early finish. This can result in a different starting point for the backward pass from each end activity.

Once the project completion date has been determined, the calculation of late dates during the backward pass proceeds in a manner entirely analogous to the calculation of early dates during the forward pass.
- **Out of Sequence Options** — You can select one of the following options for calculating dates for activities for which progress has been entered “out-of-sequence”:
 - **Ignore Positive Lag of Predecessor** — Observe relationships but ignore positive lags on relationships leading into out-of-sequence events (that is,

the start of an activity marked as in-progress or the finish of an activity marked as complete).

- **Observe Positive Lag of Predecessor** — Observe all relationships and lags leading into out-of-sequence events.
- **Ignore Predecessor Relationship** — Ignore all relationships and all lags leading into out-of-sequence events (including the finish of a continuous activity marked as in-progress). If you select this option, Open Plan does not report out-of-sequence warnings in the session log and does not delay the successors of out-of-sequence activities.

To use the Time Analysis dialog box

1. Select the project for which you want to perform time analysis.
2. On the **Project** menu, click **Time Analysis**.
3. Enter the information for the session.
4. If this is the first time to time-analyze the project, you must enter a date for Time Now.
5. When the information is correct, click **OK** to perform the operation.

Open Plan informs you if an error condition is detected during the session. You can use the **Log Viewer** to examine the error in the session log.



For more information on the **Log Viewer**, refer to Chapter 24, “System Utilities.”

Using the Time Analysis Button on the Toolbar

If you wish to perform time analysis without displaying the **Time Analysis** dialog box, simply click the **Time Analysis** button on the toolbar. When you perform time analysis using this method, the settings that were last set on the **Time Analysis** dialog box control the operation. If you have not entered a Time Now for the project, Open Plan automatically displays the **Time Analysis** dialog box before allowing you to proceed.

To perform time analysis from the toolbar

1. Select the project for which you want to perform time analysis.
2. On the toolbar, click the **Time Analysis** button.

Open Plan informs you if an error condition is detected during the session. You can use the **Log Viewer** view the contents of the session log.



For more information on the **Log Viewer**, refer to Chapter 24, “System Utilities.”

Group Process Time Analysis

You can also perform time analysis in **Batch Mode**. This allows you to run time analysis for multiple projects at one time. To run time analysis in **Batch Mode**, select more than one project from the **Details** pane of the Open Plan Explorer, and

click the **Time Analysis** button. The **Time Analysis [Batch Mode]** dialog box will be displayed. Set your options, and click **OK**.

If a project is closed, Open Plan will open it in **Exclusive** mode, perform the process, save the changes, and then close the project. If a project cannot be opened in **Exclusive** mode (because another user has it open in **Exclusive** or **Shared** mode), it will be skipped.

If you have a project open when the batch process is run, time analysis will be performed on the project, but the changes will not be saved and the project will remain open. You must manually save the changes yourself.



Time analysis for multiple projects can also be run by selecting a group of projects and clicking the **Time Analysis** button on the toolbar. See the previous section for toolbar procedures.



Open Plan creates one time analysis session log, listing the project results in the order in which the projects were processed in the batch.

Using Automatic Time Analysis

Open Plan includes an automatic mode that performs time analysis whenever you:

- Change the logic of the project by cutting, pasting, adding, or deleting an activity
- Change activity information such as target dates or durations
- Enter progress information about activities
- Change project information such as the target dates or Time Now

If you are using the Desktop edition of Open Plan, automatic time analysis is turned on by default.

To enable or disable the automatic time analysis mode, select the **Analyze Each Time Data Changes** option on the **Time Analysis** dialog box:

Select to enable automatic time analysis

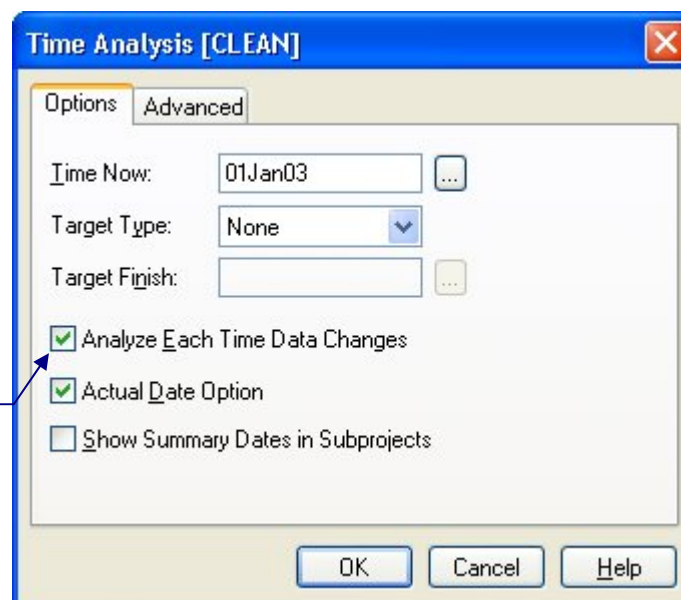



If you are using the Desktop edition of Open Plan and have not defined Time Now, Open Plan assumes Time Now to be the current system date when performing an automatic time analysis. (Time Now is the project status date. All project information is assumed to be correct up to Time Now, and Open Plan will not schedule any activities prior to this date.) If this is not appropriate for your project, you can set the value of Time Now on either the **Time Analysis** dialog box or the **Status** tab of the **Project Properties** dialog box.

To use automatic time analysis

1. Select the project for which you want to perform time analysis.
2. On the **Project** menu, click **Time Analysis**.
3. On the Options tab, select **Analyze Each Time Data Changes**.
4. Click **OK**.



Time analysis will be performed at this point and subsequently every time relevant data changes.

14

Resource Scheduling

➤ Overview	319
➤ What is Resource Scheduling?	320
➤ Resource Scheduling Attributes for Activities	323
➤ Performing Resource Scheduling	328
➤ Advanced Resource Scheduling Options	332
➤ Using Resource Scheduling Information.....	338
➤ Reporting on Resource Scheduling	340

Overview

Open Plan provides a sophisticated and comprehensive resource scheduling algorithms designed to produce resource solutions across a wide range of situations. Open Plan resource scheduling includes extensive modeling capabilities that allow planners to juggle schedules based on various combinations of time and resource constraints.

This chapter begins with a brief introduction to resource scheduling in Open Plan, followed by a description of the different scheduling attributes available for activities. The chapter continues with a description of how to perform resource scheduling in Open Plan, including information about advanced resource scheduling options. The chapter concludes with discussions on using resource scheduling information and reporting the results of resource scheduling results.



For a complete description of the calculations performed by resource scheduling, refer to Chapter 10, "Resource Scheduling Calculations," in the *Deltek Open Plan Developer's Guide*.

What is Resource Scheduling?

The purpose of resource scheduling is to calculate a project schedule that takes into account the limited availabilities of resources as well as the durations, logical relationships, and target dates of the activities. To help you understand how resource scheduling works, this section contains discussions of the following topics:

- Resource scheduling methods
- Effect of reservations on resource scheduling
- The results of resource scheduling calculations
- Resource scheduling rules

Resource Scheduling Methods

Open Plan provides two basic methods for calculating resource scheduling data:

- Time-limited resource scheduling
- Resource-limited resource scheduling

Time-limited resource scheduling places a priority on maintaining the overall project completion date while attempting to minimize the extent to which any resource is over utilized. In time-limited resource scheduling, constraints on resource availabilities are not allowed to delay the overall completion date of the project. As a result, resources may be overloaded if necessary to prevent an activity from finishing after its late finish date.

Time-limited resource scheduling places all scheduled dates between the early and late dates of activities. Thus, only activities not on the project critical path can be delayed by resource constraints.

By specifying a sufficiently low resource availability, you can use time-limited resource scheduling to calculate activity dates that minimize the over-utilization of resources without interfering with the project completion date. (This process is sometimes referred to as “resource leveling.”)

In contrast to time-limited scheduling, resource-limited resource scheduling places a priority on preventing the over utilization of resources, even if that means delaying the project finish beyond its early finish. In the absence of thresholds or immediate activities (discussed later in this chapter), resource-limited resource scheduling delays project completion if necessary to ensure that the resource requirements do not exceed availabilities.

Effect of Reservations on Resource Scheduling

Open Plan offers the ability to reserve resources for particular projects, either for all time or for specific periods. Resource Scheduling does not include resource availability reserved for another project. The effect of reservations on resource scheduling depends on the type of resource scheduling that is performed and the options that have been set.

When an activity belongs to an external subproject, the availability considered for scheduling that particular activity includes:

- The availability reserved for the subproject

- Any higher-level subprojects to which it belongs
- The main project



For more information on reserving resources for projects, refer to Chapter 7, “Resource Definitions,” and also Chapter 10, “Resource Scheduling Calculations,” in the *Deltek Open Plan Developer’s Guide*.

The Results of Resource Scheduling Calculations

When you perform resource scheduling in Open Plan, the following data is calculated.

- Scheduled dates — A set of activity start and finish dates as follows:
 - Scheduled start — The proposed date on which an activity should start based upon both project logic and resource constraints. A scheduled start date for an activity can never be earlier than its early start date calculated by time analysis.
 - Scheduled finish — The proposed date on which an activity should finish based on both project logic and resource constraints. A scheduled finish date for an activity must be the same or later than its early finish date calculated by time analysis.
- Earliest feasible date — The earliest date on which the activity could be scheduled to start based on the scheduled dates of all its predecessors but in the absence of any resource constraints on the activity itself.
- Scheduled duration — The computed duration of the activity. The scheduled duration of an activity can never be shorter than its original duration. A scheduled duration can, however, be longer than the original duration in cases where the activity was split, stretched, or reprofiled during resource scheduling.



For information about activity splitting, stretching, and reprofiling, refer to the “Resource Scheduling Attributes for Activities” section later in this chapter.

Resource Scheduling Rules

When performing resource scheduling, Open Plan follows a number of general rules regarding the calculation of dates.

- Open Plan uses a serial method of resource scheduling. This means that activities are scheduled one at a time. Once an activity is scheduled, it is not reconsidered based on the needs of subsequent activities. The order in which activities are scheduled is determined by the project logic and can be modified only to a limited extent by defining the priority fields used for the calculations.



For information on defining priority fields, refer to the “Resource Scheduling Processing Options” section later in this chapter.

- Open Plan uses the late dates to determine when an activity is being delayed enough to delay the project completion. Therefore, if you change Time Now, you should rerun time analysis before performing resource scheduling.

- Activity durations are never shortened but may be lengthened due to stretching, splitting, or reprofiling. If lengthened in any of these ways, the new duration is placed in the scheduled duration field, not in the original activity duration field.
- Resource scheduling does not violate project logic. This means that activities are available to be scheduled only after all of their logical predecessors have been scheduled. This means that no activity will be scheduled before its early dates.
- Resource-limited resource scheduling does not consider an availability in excess of the defined resource availability except for immediate activities (which are scheduled on the earliest feasible date whether or not resources are available) or when thresholds are in use.



For information about immediate activities, refer to the “Resource Scheduling Attributes for Activities” section in this chapter.

- Time-limited resource scheduling schedules within the late finish date of the activity if there is no negative float. If an activity has negative float, Open Plan schedules on the early finish date of this activity.

Resource Scheduling Attributes for Activities

Splitting, stretching, and reprofiling are three activity attributes that can be used to add flexibility to the treatment of an activity during resource scheduling. Each of these techniques can be regarded as a way to improve the performance of a project by relaxing the rules of resource scheduling in a particular way.

It is also possible to assign the **Immediate** attribute to an activity. The **Immediate** attribute removes flexibility from resource scheduling calculations by forcing Open Plan to schedule an activity on the earliest date possible.

Each attribute is described in the following sections.



For more information about activity attributes, refer to Chapter 10, "Resource Scheduling Calculations," in the *Deltek Open Plan Developer's Guide*.

Activity Splitting

Activity splitting allows an activity duration to be split into two or more pieces. Use of this attribute may permit the activity to be scheduled earlier than would otherwise be possible due to gaps in the availability of a required resource. For example, suppose that 3 units of a resource are available on January 1 and January 2. On January 3, only 1 unit of the resource is available, and on January 4 and January 5, 3 units of the resource are again available. This is illustrated in the following profile:

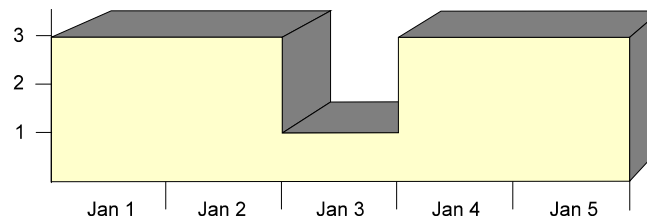

Normally, a 4-day activity with a requirement of 3 units per day could not be scheduled during this period since there are not 4 consecutive days in which the necessary resources are available. As a result, either the activity must be delayed or the resource availability exceeded. If the activity can be split, however, it is possible to schedule the activity in two pieces with one 2-day piece starting on January 1 and the second 2-day piece starting on January 4.

Two parameters control the splitting of an activity during resource scheduling: the minimum duration of an activity piece and the maximum number of pieces.

Activity Stretching

A stretchable activity is an activity whose duration can be lengthened by Open Plan during resource scheduling in order to reduce the peak requirement for a constraining resource and thus obtain an earlier scheduled date. For example, assume that a 2-day activity with a requirement of 6 resource units per day is scheduled against a resource with an availability of only 4 units per day:

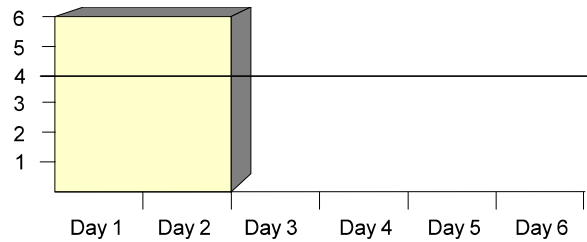

If the availability of the resource cannot be exceeded, Open Plan delays the activity. However, by stretching the duration of an activity to 3 days (reducing the requirement to 4 units per day), it is possible to reduce the peak requirement of the activity enough to permit the scheduling of the activity:

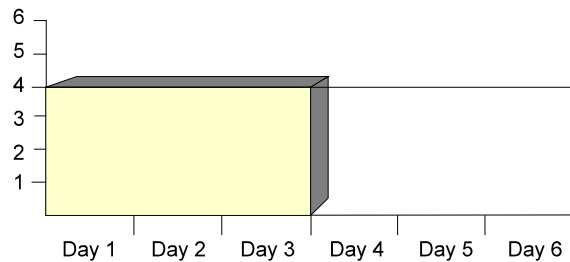

The total resource requirement of the activity remains unchanged.

To control the effects of stretching during resource scheduling, Open Plan allows you to enter a maximum duration for the activity.

Activity Reprofileing

Reprofileing provides Open Plan with the most flexibility in scheduling an activity. An activity with this attribute can be scheduled in any way consistent with available resources so long as the following criteria are met:

- The duration of the reprofiled activity cannot be shorter than the specified duration.
- The reprofiled requirements cannot exceed the original requirements profile (on a cumulative basis).

Thus a 10-day activity with a resource requirement of 3 units per day cannot be reprofiled so that it has a 1-day duration with a requirement of 30 units.

To see how reprofileing works, assume that a 3-day activity has a resource requirement of 5 units per day for a total of 15 units. Depending on the availability of the resources, the activity can be reprofiled in any number of ways, including the following examples:

- 5 days at 3 units per day
- 4 days at 2 units per day, followed by 1 day at 7 units per day
- 5 days at 1 unit per day, followed by 1 day at zero units per day, followed by 1 day at 10 units per day

To control the effects of reprofileing during resource scheduling, Open Plan allows you to enter a maximum duration for the activity.

The Immediate Attribute

By assigning the **Immediate** attribute to an activity, you instruct Open Plan to start the activity on its earliest feasible date even if that means overloading a resource. The earliest feasible date for an activity is a date calculated by resource scheduling and represents the earliest possible date an activity can start, taking into account delays in preceding activities but in the absence of any constraints on its own resources.

Assigning Scheduling Attributes to Activities

To assign scheduling attributes to an activity, display the **Advanced** tab of the **Activity Details** dialog box.

The screenshot shows the 'Activity Details [CLEAN]' dialog box with the 'Advanced' tab selected. The fields are as follows:

- ID:** 1.04
- Desc.:** Environmental Package Design Specifications
- Status:** Planned
- Duration:** 92d
- Calendar:** 1
- Type:** Subproject
- Target Dates:** Start: None, Finish: None
- Subproject:** (empty)

The dialog includes a 'Close' button, an 'Undo' button, an 'Apply' button, a 'New' button, a 'Progress...' button, and a 'Help' button. There are also navigation arrows at the bottom left.

This tab allows you to enter the following settings.

- **Type** — You can define the scheduling attribute of the activity as one of the following types:
 - Normal (the default)
 - Splittable
 - Stretchable
 - Reprofilable
 - Immediate
- **Min Duration** — If you define the activity as splittable, you can specify the minimum duration for each piece.
- **Max Splits** — If you define the activity as splittable, you can specify the maximum number of splits allowed.
- **Max Duration** — If you define the activity as either stretchable or reprofilable, you can specify the maximum duration allowed.
- **Priority** — This field controls the priority Open Plan gives the activity during resource scheduling and acts as a tie-breaker. You can enter any 3-digit number. Lower numbers indicate a higher priority than higher numbers. The

default for this field is zero (and, therefore, top priority). Negative numbers are allowed.



For this setting to take effect, you must also select **Priority** as one of the priorities on the **Advanced** tab of the **Resource Scheduling** dialog box.

- **Separate Resources** — You can define whether Open Plan should consider multiple assignments to the same pool separately.
- **Suppress Requirements** — You can define whether Open Plan should ignore resource requirements for the activity during resource scheduling.
- **Earned Value** — You can specify the performance measurement technique (EVT) for the activity. When the **Base Physical Percent Complete on EVT** option is selected on the **Progress Calculations** dialog box, Open Plan uses the selected EVT to update the earned value of the activities when progress calculations are run.

The **Earned Value** section contains two data fields:

- **EVT** — You can select from the list of EVT's as described below.
- **Start %** — This field is enabled when you select **User-Defined Percentage** for the EVT. You can enter the starting percentage an activity earns in this field. The remainder is earned when the activity is completed.

EVT options for selection:

- **Level of Effort** — This EVT assumes that if the activity has started, it will progress (and, thus, earn value) according to the original budget without deviation. By definition, the value earned by an activity using this EVT is equal to the budget up to Time Now. In other words, starting a Level of Effort (LOE) activity results in the activity immediately earning its entire budget up to Time Now.
- **Percent Complete** — With this EVT, the user enters percent complete directly. Percent complete places the burden of objective performance measurement on the individual or system that provides the information.
- **50-50** — With this EVT, 50% of the value is earned as soon as the activity is started, and the rest is earned when it is completed. Since value cannot be earned in any intervening periods, this EVT is best used for activities that span a maximum of two fiscal periods.
- **0-100** — With this EVT, no value is earned until the activity is completed. At which point, the entire budget is earned. This method is best used if the activity is scheduled to start and finish in the same fiscal period.
- **100-0** — With this EVT, all the value is earned as soon as the activity is started. This method is best used if the activity is scheduled to start and finish in the same fiscal period.
- **User-Defined Percentage** — This EVT is a variation of the 50-50 EVT. The percentage earned at the start of the activity (1 to 99%) is defined in advance by the user by entering the percentage in the Start % field. The remainder is earned when the activity is completed. This method is best used for activities whose schedule dates span a maximum of two fiscal periods

- **Planning Package** — Activities using this EVT are used for planning purposes only and do not earn value. This causes earned value to always be calculated as zero regardless of any progress that has been applied.
- **Resource Assignment % Complete** — This EVT allows you to enter status and calculate earned value at the resource assignment level. This option is useful when you have long activities and your resources are not spread across the entire activity. An example is when you have many resources assigned to a single work package.

There are few hard and fast rules about selecting performance measurement techniques. The general rule is to select a method that allows you to "earn how you plan." For example, if an activity spans two periods and the budget spread is \$50 in the first period and \$50 in the second period, you should select a EVT that, if on schedule, would allow you to earn half of the \$100 budget when the activity is started and the other half when it is finished. (This scenario would most likely use the 50-50 EVT.)



50-50, 0-100, 100-0, and User-Defined Percentage EVTs are normally used on activities that span no more than two periods.

To assign scheduling attributes

1. Display the **Activity Details** dialog box for the desired activity.



For information on displaying the **Activity Details** dialog box, refer to Chapter 6, "Activity Information."

2. Click the **Advanced** tab.
3. Enter the information for the scheduling attributes of the activity.
4. When the information is correct, click **OK**.

Performing Resource Scheduling

When you click the **Resource Scheduling** command on the **Project** menu, Open Plan displays the **Options** tab of the **Resource Scheduling** dialog box:

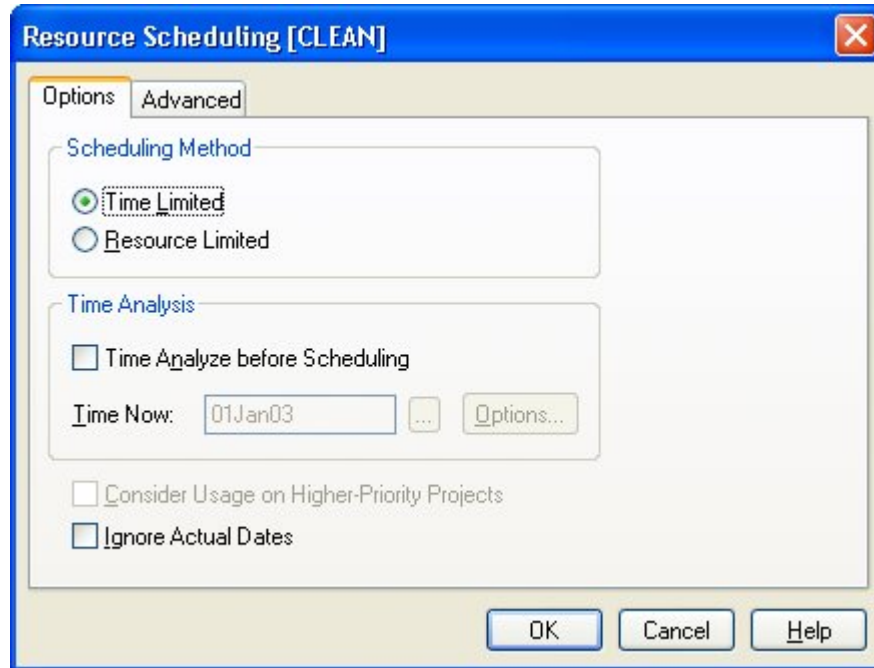

Use this tab to enter the following settings about the resource scheduling operation:

- **Scheduling Method** — You can choose either of the following methods:
 - **Time Limited** — Time-limited resource scheduling places a priority on maintaining the overall project completion date while attempting to minimize the extent to which any resource is over-utilized. In time-limited resource scheduling, constraints on resource availabilities are not allowed to delay the overall completion date of the project. As a result, resources may be overloaded if doing so prevents an activity from finishing after its late finish date.

Time-limited resource scheduling places all scheduled dates between the early and late dates of activities. Thus, only activities not on the project critical path can be delayed by resource constraints.



By specifying a sufficiently low resource availability, you can use time-limited resource scheduling to level the overall resource requirements for a project.

- **Resource Limited** — Resource-limited resource scheduling places a priority on preventing the over-utilization of resources, even if that means delaying the project beyond its early finish date.

In the absence of thresholds, immediate activities, or subproject requirements, resource-limited resource scheduling uses only those resource availabilities that have not been reserved for another project and

delays project completion to ensure that the resource requirements do not exceed availabilities.



The use of resource availability thresholds, immediate activities, or resource assignments on subprojects may cause resource overloads even when performing resource-limited resource scheduling.

- **Time Analysis** — If you wish, you can have Open Plan perform a time analysis of the project before the resource scheduling operation. To invoke time analysis, select **Time Analyze Before Scheduling**. (If you have not already performed time analysis on the project, Open Plan selects this option automatically.) To set the time analysis options, click **Options**.



For information about time analysis processing options, refer to Chapter 13, “Time Analysis.”

- **Consider Usage on Higher Priority Projects** — If this option is selected, Open Plan will not use resources that are currently scheduled to be used by other projects that have a higher priority. (Project priority is defined on the **Scheduling** tab of the **Project Properties** dialog box where lower numbers represent higher priorities.)

If another project has reserved a portion of a resource's availability, the reserved portion is not available to your project regardless of whether you select this option or of the relative priorities of the projects.

A resource is not double-counted if it is used by the project to which it was reserved and is not available to the current project.

For example, 75% of a resource is reserved for a particular project, leaving 25% not reserved available for the current project.

- If the project uses only 60% of the resource instead of 75%, there is still only 25% available for the current project. (Open Plan does not recognize the difference between what was used and what was reserved if the usage is lower than quantity reserved.)
- If, on the other hand, the project uses 80% of the resource, the difference between what is used and what is reserved is subtracted from the 25% not reserved. This leaves only 20% available for the current project.

When scheduling a number of projects together (using external subprojects), the scheduling priority is that for the master project. (Of course, this does not prevent you from using the individual project priorities as one of the priority fields used to break ties between individual activities.) To do this, you need to create a calculated field with the **Project Priority** field (`_PRJ.RS_PRIORITY`) as the expression.



For more information on how to create a calculated field, refer to Chapter 23, “Project Utilities.”

- **Ignore Actual Dates** — This option controls whether Open Plan should ignore actual dates when performing resource scheduling:

- If this option is selected, Open Plan ignores actual dates when performing resource scheduling.
- If this option is cleared, Open Plan does not ignore the actual dates when performing resource scheduling. This is the default setting.

At the conclusion of each resource scheduling session, Open Plan creates and saves a session log that records any system or error messages issued during the operation. You can view the session log file (Opp_rs.log) once the processing is complete.

To perform resource scheduling using the Resource Scheduling dialog box

1. Select the project for which you want to perform resource scheduling.
2. On the **Project** menu, click **Resource Scheduling**.
3. Enter the information for the session, and click **OK**.

Open Plan informs you if an error condition is detected during the session. You can use the **Log Viewer** to examine the error in the session log.



For more information on the **Log Viewer**, refer to Chapter 24, "System Utilities."

Using the Resource Scheduling Button on the Toolbar

To perform resource scheduling without displaying the **Resource Scheduling** dialog box, simply click the **Resource Scheduling** button on the toolbar.

When you perform resource scheduling using this method, the settings stored on the **Resource Scheduling** dialog box control the operation. If you have not performed resource scheduling for the project, Open Plan automatically displays the **Resource Scheduling** dialog box before allowing you to proceed.

To perform resource scheduling with the toolbar

1. Select the project for which you want to perform resource scheduling.
2. On the toolbar, click the **Resource Scheduling** button.

Open Plan informs you if an error condition is detected during the session. You can use the **Log Viewer** to examine the error in the session log.



For more information on the **Log Viewer**, refer to Chapter 24, "System Utilities."



Resource Scheduling button

Group Process Resource Scheduling

You can also perform resource scheduling in **Batch Mode**. This allows you to run resource scheduling for multiple projects at one time. To run resource scheduling in **Batch Mode**, select more than one project from the **Details** pane of the Open Plan Explorer, and click the **Resource Scheduling** button. The **Resource Scheduling [Batch Mode]** dialog box will be displayed. Set your options, and click **OK**.

If a project is closed, Open Plan will open it in **Exclusive** mode, perform the process, save the changes, and then close the project. If a project cannot be

opened in **Exclusive** mode (because another user has it open in **Exclusive** or **Shared** mode) it will be skipped.

If you have a project open when the batch process is run, resource scheduling will be performed on the project, but the changes will not be saved and the project will remain open. You must manually save the changes yourself.



Resource scheduling for multiple projects can also be run by selecting a group of projects and clicking the **Resource Scheduling** button on the toolbar. See the previous section for toolbar procedures.



Open Plan creates one time analysis session log, listing the project results in the order in which the projects were processed in the batch.

Advanced Resource Scheduling Options

The **Advanced** tab of the **Resource Scheduling** dialog box displays resource scheduling options that are seldom changed. Once you have specified a set of resource scheduling options for a particular project, these options remain the defaults for that project each time it is scheduled.

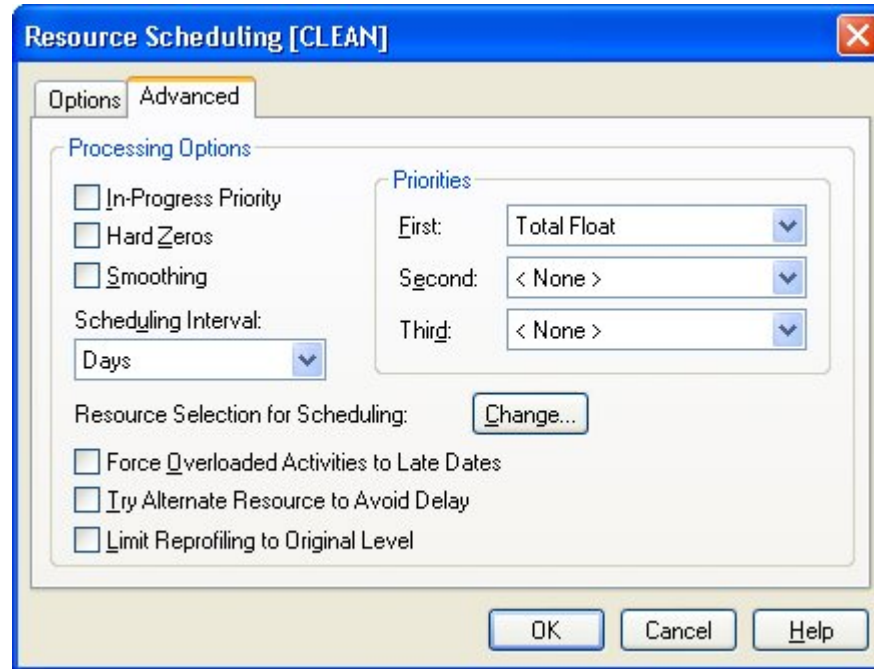

Use the **Advanced** tab to set the following options:

- In-Progress Priority
- Hard Zeros
- Resource Smoothing
- Priority Fields
- Scheduling Interval
- Resource Selection
- Force Overloaded Activities to Late Dates
- Try Alternate Resource to Avoid Delay
- Limit Reprofile to Original Level

In-Progress Priority

The **In-Progress Priority** option allows you to specify that in-progress activities have priority access to limited resources. This tends to prevent the splitting (and thus the delay) of activities that have already started.

Hard Zeros

The **Hard Zeros** option exempts any resource availability of zero from being incremented through the use of thresholds or during time-limited resource scheduling. For example, assume that a resource availability has been defined as the following:

Level	From	To
5	01Jan04	10Jan04
5	20Jan04	31Jan04

Since there is no entry for the dates between 11Jan04 and 19Jan04, there is an implied availability of zero for this resource during that period. In normal time-limited scheduling (or in resource-limited scheduling when resource thresholds are involved), the availability of the resource between these dates could be increased from its implied level of zero if it were necessary to prevent a delay in the project.

By contrast, if the **Hard Zeros** option were in effect, the availability of the resource during that period would never be increased under any circumstances.



For information about interpreting zero availabilities, refer to Chapter 7, "Resource Definitions." For more information on the hard zeros processing option, refer to Chapter 10, "Resource Scheduling Calculations," in the *Deltek Open Plan Developer's Guide*.

Resource Smoothing

During time-limited resource scheduling, the **Smoothing** option attempts to even out or "smooth" the way in which resources are assigned to activities. Without this option set, Open Plan assumes that if the availability of a resource has been exceeded once, the amount of the overload should be used again in preference to using float. With this option set, Open Plan assumes that even though an availability has been exceeded, available float should be used in preference to overloading the resource again.

For example, assume that four independent activities require a resource whose availability is 1 unit per day. Three of the activities have 1-day durations and 3 days of total float each. They require 1 unit of the resource per day. The fourth activity has a duration of 4 days and zero total float. This activity requires 3 units of the resource but only on the fourth day of its duration. Because it has zero float, the fourth activity assumes the default settings and is scheduled first. With normal time-limited scheduling, Open Plan assumes that since it is necessary to exceed the resource availability once by 2 units to schedule the fourth activity, it is permissible to exceed that availability by 2 units at any time. As a result, it proceeds to schedule the first three activities on their early dates:

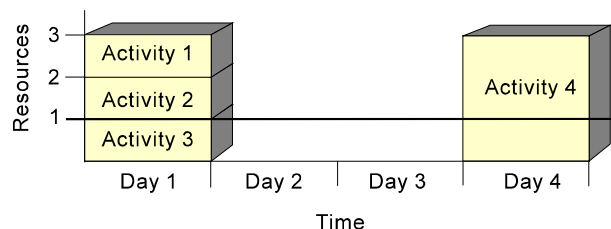

With the **Smoothing** option in effect, however, no resource availability is exceeded unless it is strictly necessary to schedule the activity:

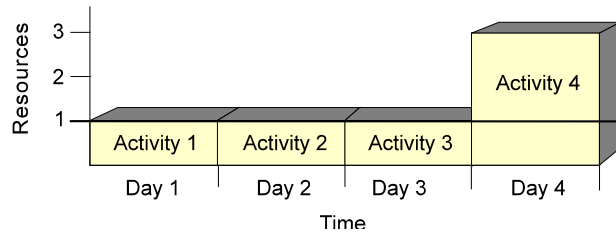

If smoothing is turned off when you perform resource scheduling, the error log includes a message only for the first time the resource requirement exceeds the availability.

It is important to remember that in certain situations, the **Smoothing** option may result in an increase in the total resource requirements for the project. Therefore, if you wish to minimize the extent to which resources may be overloaded, do not use smoothing.

In general, the following guidelines may help you decide whether to turn the **Smoothing** option on or off:

- Turn smoothing on if only a few activities have a large resource overload but the rest of the project does not.
- Turn smoothing off if the project as a whole has a large resource overload. This has the effect of scheduling activities close to their early dates where possible, minimizing the possibility of causing an unnecessary overload later.

To determine the best way to set the **Smoothing** option for your situation, compare the results of resource scheduling with smoothing turned on and with smoothing turned off.



For a complete discussion of resource smoothing, refer to Chapter 10, "Resource Scheduling Calculations," in the *Deltek Open Plan Developer's Guide*.

Priority Fields

Open Plan provides three priority fields that are used as tiebreakers during resource scheduling. You can use any activity-related field as a tiebreaker with the exception of enumerated fields (for example, **Activity Type**) since there is no defined sort order for such fields and note categories. Lower values or earlier dates indicate a higher priority. Negative numeric values are allowed.



If the **In-Progress Priority** option is on, activities in progress always have the highest priority in resource scheduling regardless of the values stored in their priority fields.

The default for the first priority tiebreaker is set to **Total Float**. Since lower values have a higher priority than higher values, this field tends to schedule activities on the project's critical path first. In most cases you should leave this field selected as the first priority field because it tends to produce the most efficient schedules. (If critical activities are delayed, the project is automatically delayed by that same amount of time.)

You may want to design your own priority system to control the scheduling of activities. Typically, you might define a numbering system based from 1 to 10 or perhaps 1 to 100. The numbering system and the range you use should be based on the size of the project and the degree of detail necessary. A field labeled **Priority** on the **Advanced** tab of the **Activity Details** dialog box is available for this purpose, but it would also be possible to specify a calculated field as a priority field.

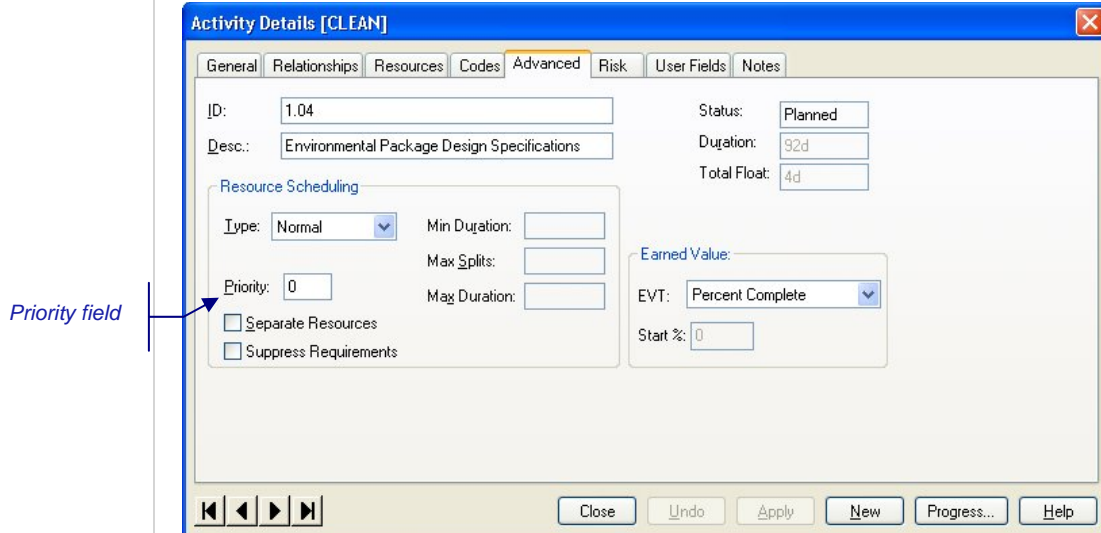

Open Plan also provides two special-purpose priority fields that you can use for resource scheduling purposes: **<Hierarchical Priority Field>** and **<Remaining Float>**.

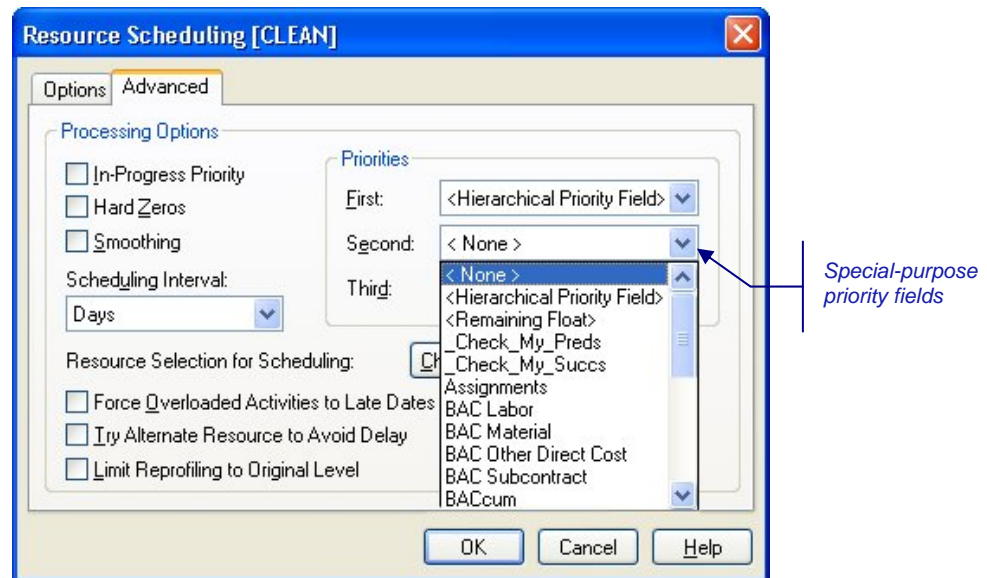

These special fields function as follows:

- **<Hierarchical Priority Field>** — Open Plan refers to the priority field of the parent activities when attempting to break a tie between two activities.
- **<Remaining Float>** — Open Plan uses the activity's remaining float (that is, the difference between the late start and the earliest feasible start — this value is calculated during the course of resource scheduling) when determining priorities.



For a complete discussion of the effect of priority fields, refer to Chapter 10, "Resource Scheduling Calculations," in the *Deltek Open Plan Developer's Guide*.

Scheduling Interval

The **Scheduling Interval** setting defines the granularity with which Open Plan matches up resource assignments and availabilities. Thus, if you define the scheduling interval for resource scheduling as hours, Open Plan schedules an activity only when the required resources are available for each hour of the activity duration. By increasing the scheduling interval to days, you allow Open Plan to schedule the activity on any day for which sufficient resource availability exists, even if the hours of the assignment and the hours of the availability do not exactly match.

By reducing the scheduling interval, you increase the precision of the resource scheduling results. On the other hand, you also increase the processing time required to yield these results. Increasing the scheduling interval should speed up resource scheduling calculations at the cost of slightly less precise results.

To specify the largest scheduling interval that still maintains maximum accuracy, select an interval that matches the lowest common denominator of all durations. For example, if you know that all activity durations are defined as multiples of 2 hours, then select 2 hours as the scheduling interval.



For most projects, a daily interval is appropriate.

As a general rule, never define a scheduling interval that is smaller than necessary. For example, if you have defined all activity durations in days, changing the scheduling interval to minutes or hours will not result in more accurate resource calculations and will result in significantly increased processing times.



For more information about scheduling intervals, refer to Chapter 10, "Resource Scheduling Calculations," in the *Deltek Open Plan Developer's Guide*.

Resource Selection

By default, all resources in the resource definition file that are required by project activities represent a potential constraint on when activities are scheduled. By clearing some resources, you instruct Open Plan to schedule the project as though an unlimited quantity of those resources were available.

The first time you run resource scheduling, you typically want to have all resources selected. However, if you determine that the availability of a particular resource is causing the schedule to be delayed, you may want to run resource scheduling again with that resource cleared. You might also want to see how selecting or clearing various resources would affect the schedule.



Resources remain selected or cleared until the option is changed in a subsequent resource scheduling session.

Force Overloaded Activities to Late Dates

This option controls whether Open Plan should force overloaded activities to their late dates rather than to their early dates:

- If selected, this option forces overloaded activities to their late dates.
- If cleared, this option forces overloaded activities to their early dates.

Try Alternate Resource to Avoid Delay

This option controls the use of alternate resources in resource scheduling:

- If selected, this option instructs Open Plan to try using the alternate resource if using the original resource would cause the activity to be delayed beyond its earliest feasible date.
- If cleared, this option instructs Open Plan to use the alternate resource only to avoid overloading (time-limited resource scheduling) or exceeding the late dates (resource-limited resource scheduling).

Limit Reprofileing to Original Level

This option controls whether Open Plan should limit the reprofiling of a resource assignment to a level that does not exceed the original profile for any given unit of duration:

- If selected, this option instructs Open Plan to limit reprofiling to the original profile.
- If cleared, this option instructs Open Plan to not limit reprofiling to the original profile.

Using Resource Scheduling Information

Although the procedures for performing resource scheduling in Open Plan are relatively straightforward, the use of resource scheduling information for planning purposes is usually an iterative process that must be repeated until acceptable results are obtained. The following procedure may provide some guidelines about the steps you should follow when integrating resource scheduling information in the overall planning process.

Step 1 — Perform time analysis and evaluate the schedule. By default, Open Plan uses the total float calculated by time analysis in resource scheduling. In addition, since the dates calculated by time analysis do not consider resources, resource scheduling never produces earlier dates than time analysis. Therefore, there is little point in proceeding with resource scheduling if the dates produced by time analysis are later than those acceptable to your organization.



For information on time analysis, refer to Chapter 13, “Time Analysis.”

Step 2 — If necessary, replan the project. It is important that you have a finish date that is acceptable before proceeding.

Step 3 — Perform resource scheduling. There are two basic approaches to resource scheduling: time-limited and resource-limited.

- Time-limited resource scheduling asks the question, “When and where do I need extra resources in order to meet the dates?”
- Resource-limited scheduling asks the question, “How much will the project be delayed because I do not have enough resources?”

Although you will certainly want to try both methods so that you can compare the results, your circumstances will dictate which method you should try first. (Time-limited and resource-limited scheduling are discussed in greater detail elsewhere in this chapter.)

Step 4 — To see the effect of resources on the project schedule, compare the scheduled dates calculated by resource scheduling to the early and late dates calculated by time analysis. In resource-limited scheduling, a large difference between an activity’s early start date and its earliest feasible date indicates that resource bottlenecks earlier in the project are producing delays in the schedule.

Step 5 — To identify cases of resource over utilization, display a resource histogram view that compares resource requirements to availabilities.

Step 6 — If you are not satisfied with either the scheduled dates or the levels of resource utilization, you can make adjustments to the resource usage in a number of ways:

- You can identify over-utilized resources and substitute under-utilized resources for them.
- You can permit Open Plan to split, stretch, or reprofile activities whose durations do not have to be uninterrupted.
- You can select a different processing option and rerun resource scheduling. Processing options include resource smoothing, giving in-progress activities higher priority, and using different fields for establishing project priorities.

Step 7 — Recalculate the schedule using time analysis (if you have made any changes to the project logic) and resource scheduling.

Step 8 — Repeat the entire procedure as needed to develop a workable schedule.

Reporting on Resource Scheduling

Although it is possible to display any data calculated by resource scheduling in a tabular format, Open Plan also provides a number of views that display resource scheduling results graphically. For example, to show the potential effects of resource constraints on activity schedules, open the standard resource barchart view after you have performed resource scheduling:

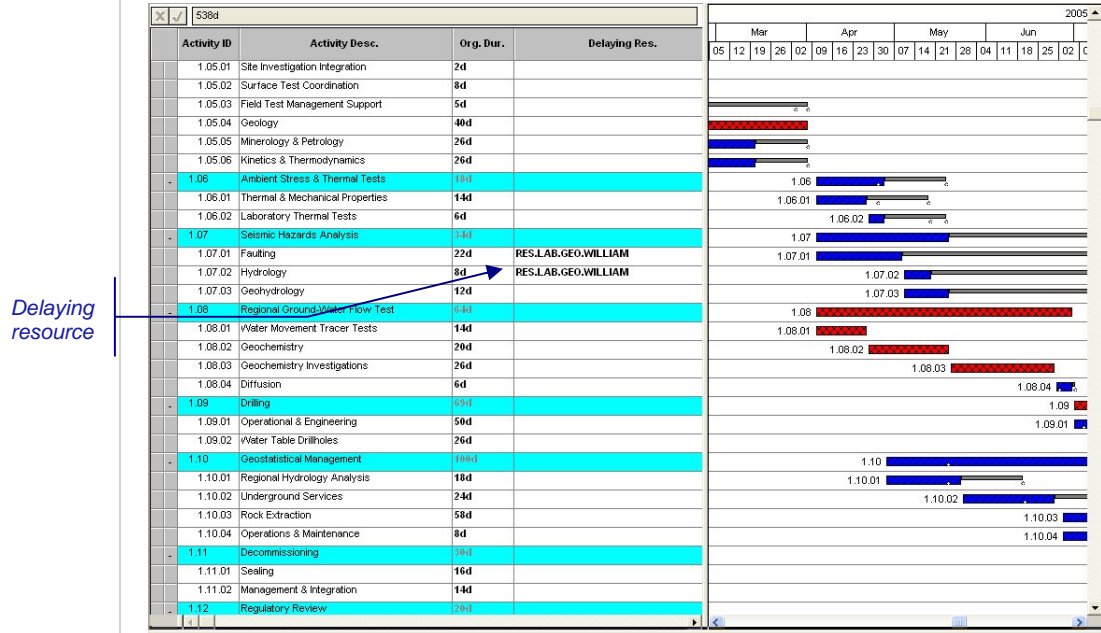

In this view, Open Plan displays bars for both early and scheduled dates. If the scheduled start date is later than the earliest feasible start date for an activity (that is, if a resource assigned to the activity is causing it to be delayed beyond its earliest possible start), Open Plan changes the color of the bar, displays an arrow indicating the earliest feasible start date, and displays the name of the resource causing the delay.

By enlarging the histogram portion of the view, it is possible to compare availability and assignment information for specific resources:

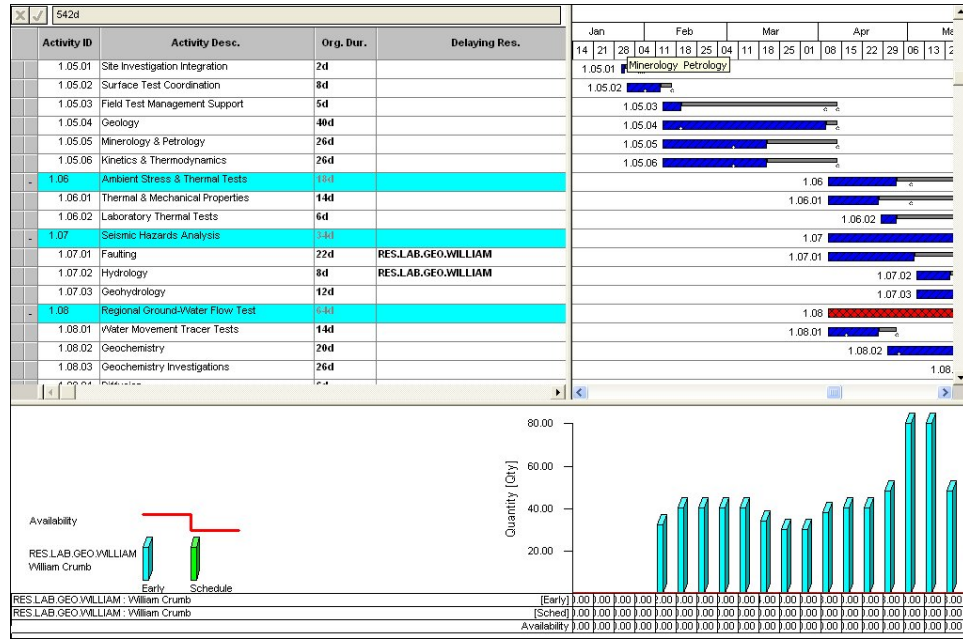

This type of view makes it easy to focus in on the resource problems that have a direct impact on schedule performance.

15

Risk Analysis

➤ Overview	345
➤ Defining Activity Risk.....	346
➤ Risk Analysis Operations	349
➤ Interpreting the Results of Risk Analysis	353
➤ Risk Histograms	355

Overview

Project management decisions are concerned with the future. While planners hope to influence the outcome of events by the decisions they make, everything about the future is, to a greater or lesser extent, uncertain. The techniques of risk analysis were developed to provide a consistent methodology for quantifying this uncertainty with the ultimate goal of improving the quality of decisions.

By definition, project management involves the planning and coordination of large numbers of activities for which there are often no precise precedents. The durations and costs of the individual activities making up the project cannot be known exactly before the project begins. Clearly a project plan is, by its very nature, a forecast and thus contains elements of uncertainty.

Using the tools of risk analysis, Open Plan allows you to quantify the uncertainties associated with project durations. When using this feature, you enter three durations (optimistic, pessimistic, and most likely) for activities. During the risk analysis process, Open Plan estimates the duration for these activities using random numbers and runs time analysis a large number of times. By precisely defining the probable range of the durations of each activity, Open Plan provides you with the means to model the impact of these uncertainties on such critical areas as:

- The project completion date
- The feasibility of achieving specific target dates

Briefly stated, Open Plan risk analysis works by:

- Allowing you to enter three durations (optimistic, pessimistic, and most likely) and probability distributions for each activity.
- Allowing you to enter probability distributions for duration for some or all of the activities in a project
- Performing a risk analysis using Monte Carlo simulation to establish estimates of the effects on project dates
- Producing views and reports that can be used in analyzing the impact of uncertainties on the performance of the project

This chapter provides introductions to these topics.



For an in-depth discussion on risk analysis, begin by displaying the Help system topic "Using Risk Analysis." For a complete description of risk analysis calculations in Open Plan, refer to Chapter 11, "Risk Analysis Calculations," in the *Deltek Open Plan Developer's Guide*.

Defining Activity Risk

To use the risk analysis feature in Open Plan, you must enter duration probability information for at least one activity in a project. More typically, you enter probable durations for all activities that involve at least some degree of uncertainty in their planning.



You can enter probability information for any type of activity that does not use a calculated duration (for example, subprojects, external subprojects, or hammocks).

To enter risk information at the activity level, use the **Risk** tab of the **Activity Details** dialog box:

The screenshot shows the 'Activity Details [CLEAN]' dialog box with the 'Risk' tab selected. The 'ID' field contains '1.01.01', 'Status' is 'Planned', and 'Duration' is '30d'. Under the 'Duration' section, 'Shape' is set to 'Triangular', 'Optimistic' is '30d', and 'Pessimistic' is '40d'. The 'Probability of Occurrence' is set to '90'. There is also a 'Key Activity' checkbox which is unchecked. The dialog has several tabs: General, Relationships, Resources, Codes, Advanced, Risk, User Fields, and Notes. At the bottom, there are navigation arrows and buttons for Close, Undo, Apply, New, Progress..., and Help.

For each activity on which you want to model risk, you can enter an optimistic (minimum estimated) duration and a pessimistic (maximum estimated) duration in addition to an original duration. You can also enter a weight factor (0-100) for the **Probability of Occurrence** that indicates the probability that the activity will exist at all. For example, assume you have the following three activities:

Activity	Probability of Occurrence
A — Write Software	100
B — Test Software	100
C — Fix Software	20

Activities A and B will always happen, but we might judge that there is only a 20% chance that following testing, we have to go back and fix the software. All regular Open Plan features ignore this field (and always consider all tasks) except Risk Analysis, which would only consider activity C 20% of the time. If Risk Analysis chooses to ignore the task on any given iteration, then any successors of C are deemed to follow immediately on from B (as if C had zero duration).

You must also enter one of the following distribution shapes to define how Open Plan will sample the range of possible durations:

- **Beta** — Probable outcomes cluster around the mode value of the distribution. Outcomes at the extreme values of the distribution are very unlikely.
- **Normal** — Probable outcomes cluster symmetrically around the center of the distribution.
- **Triangular** — Probable outcomes cluster around the mode (most likely) value of the distribution. Outcomes close to optimistic and pessimistic values of the distribution still possess a significant probability.
- **Uniform** — Each outcome is equally likely.



For a complete description of these distribution shapes, refer to Chapter 11, “Risk Analysis Calculations,” in the *Deltek Open Plan Developer’s Guide*.

Note that Open Plan requires a mode or “most likely” duration for the triangular and beta distribution shapes. In these cases, the original duration of the activity is assumed to be the mode duration. For symmetrical distribution shapes (uniform and normal), a mode duration is not required for risk analysis processing. However, since virtually all processing by Open Plan other than risk analysis uses the original duration field, you should always enter this duration, no matter what type of distribution shape is specified for the activity. In fact, Open Plan checks for the validity of the duration field by verifying that its value falls between the optimistic and pessimistic duration before allowing you to store the information for the activity. An activity with a blank duration field is interpreted by Open Plan as having zero duration.

The following examples show how to specify duration probabilities for activities.

Example 1 — You estimate that an activity can have a duration of 3, 4, or 5 days. Each duration is equally likely.

- Optimistic = 3d
- Pessimistic = 5d
- Duration = 4d (not used during risk analysis)
- Shape = Uniform

Example 2 — You estimate that an activity could have a duration anywhere between 10 and 30 days based on a normal probability distribution.

- Optimistic = 10d
- Pessimistic = 30d
- Duration = 20d (not used during risk analysis)
- Shape = Normal

Example 3 — You estimate that an activity could have a duration anywhere between 10 and 30 days. You predict the most likely duration to be 12 days.

- Optimistic = 10d
- Pessimistic = 30d
- Duration = 12d
- Shape = Triangular

Example 4 — You know that an activity has a duration of 2 days.

- Optimistic = blank

- Pessimistic = blank
- Duration = 2d
- Shape = blank

Open Plan also allows you to designate one or more activities in a project as “key activities.” For key activities, Open Plan stores the most detailed risk analysis information possible. You can then use a risk histogram view to display detailed histograms for the probability distributions for such information as the early dates of selected milestone activities.



The designation of a large number of key activities can result in the creation of an unmanageably large Risk table when risk analysis is performed. Therefore, it is recommended that the number of activities flagged as key activities never exceed a dozen or so per project.

To enter risk information for an activity

1. Display the **Activity Details** dialog box for the activity.
2. Click the **Risk** tab.
3. Enter the information for the activity, and click **Close**.

Risk Analysis Operations

If you are using the Professional edition of Open Plan, you can perform a risk analysis of a project at any time. In many ways, the risk analysis function in Open Plan is similar to the time analysis process. Activities are sorted according to project logic and then subjected to a forward and backward pass in order to establish the earliest and latest dates for each activity.

In risk analysis, however, the process of calculating the early and late dates for each activity is based on a sampling of the probable durations. This sampling is repeated many times in order to build up a statistical picture of the probable outcomes of the project based on the combinations of the activities' individual durations.

Unlike time analysis, the resulting dates and values for early dates, late dates, and activity floats are not calculated as single, deterministic values. Instead, statistical means and standard deviations are used to express these values.

Another statistical measure calculated for each activity during risk analysis is a "criticality index." This index represents the percentage of simulation trials that resulted in the activity being placed on the critical path.

Open Plan provides two ways to perform risk analysis on a project:

- The **Risk Analysis** dialog box
- The **Risk Analysis** button on the toolbar

Each time you perform risk analysis using either the **Risk Analysis** dialog box or the **Risk Analysis** button, Open Plan creates a session log file that records any system or error messages issued during the operation. Open Plan saves the file (Opp_risk.log) and allows you to examine its contents at the conclusion of each session.

Using the Risk Analysis Dialog Box

When you click the **Risk Analysis** command on the **Project** menu, Open Plan displays a tabbed dialog box with two tabs: the **Options** tab and the **Advanced** tab.

The **Options** tab displays the basic settings for a risk analysis session:



Risk Analysis
button

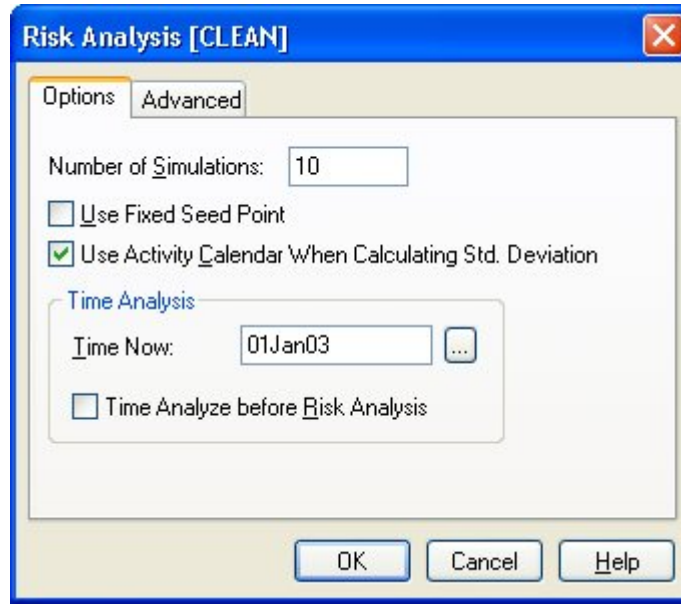

Use this tab to specify the following settings:

- **Number of Simulations** — The more simulations performed, the more accurate the results of risk analysis, but the longer the process will take. Depending on the number of activities in a project and what kind of information you are seeking, a number between 100 and 1000 simulations is usually appropriate.
- **Use Fixed Seed Point** — If you enable this setting, Open Plan uses the same starting point each time it generates random numbers to use as activity durations during the trial simulations. Thus, multiple risk analyses of identical project information will produce identical results each time.
- **Use Activity Calendar When Calculating Std. Deviation** — This option controls whether Open Plan should use the activity calendar when calculating standard deviations or calculated dates:
 - If this option is selected, Open Plan uses the activity calendar when calculating standard deviations.
 - If this option is cleared, Open Plan uses elapsed time when calculating standard deviations.
- **Time Now** — If this is the first time you have analyzed the project, Open Plan requires you to enter a date for Time Now. Time Now is the current project status date, and Open Plan will not calculate any dates prior to this date. If the project is not yet underway, enter the planned project start date for Time Now. If the project has started and you have entered progress information for one or more activities, Time Now should be the latest date for which all progress information is correct.
- **Time Analyze before Risk Analysis** — Select this option if you want Open Plan to conduct a time analysis of the current project information before continuing with risk analysis calculations. (Note that Open Plan does not require you to perform time analysis before performing risk analysis.)

There is one additional risk analysis option available on the **Advanced** tab of the **Options** dialog box:



For key activities, Open Plan provides a cumulative distribution for each calculated date and float. This information is output to the Risk table. By default, values are provided for 21 percentile points (0, 5, 10... 100).

- **RiskPercentileArraySize** — This option allows you to control this granularity by specifying the number of intervals (which will be evenly spaced).



For more information on using the **Advanced** tab of the **Options** dialog box, refer to Chapter 25, "System Defaults."

You can also use the **Advanced** tab of the **Risk Analysis** dialog box to set additional options for the operation.



For information about these options, refer to Chapter 13, "Time Analysis."

To use the Risk Analysis dialog box

1. Select the project for which you want to perform risk analysis.
2. On the **Project** menu, click **Risk Analysis**.
3. Enter the information for the session.

If this is the first time you have analyzed the project, you must enter a date for Time Now.

4. When the information is correct, click **OK**.

Open Plan informs you if an error condition is detected during the session. You can use the **Log Viewer** to examine the error in the session log.



For more information on the **Log Viewer**, refer to Chapter 24, "System Utilities."

Using the Risk Analysis Button on the Toolbar

If you wish to perform risk analysis without displaying the **Risk Analysis** dialog box, simply click the **Risk Analysis** button on the toolbar. When you perform risk analysis using this method, the settings stored on the **Risk Analysis** dialog box control the operation. If you have not entered a Time Now for the project, Open Plan automatically displays the **Risk Analysis** dialog box before allowing you to proceed.

To perform risk analysis using the toolbar

1. Select the project for which you want to perform risk analysis.
2. On the toolbar, click the **Risk Analysis** button.

Open Plan informs you if an error condition is detected during the session. You can use the **Log Viewer** to examine the error in the session log.



For more information on the **Log Viewer**, refer to Chapter 24, "System Utilities."



Group Processing Risk Analysis

You can also perform risk analysis in **Batch Mode**. This allows you to run risk analysis for multiple projects at one time. To run risk analysis in **Batch Mode**, select more than one project from the **Details** pane of the Open Plan Explorer, and click the **Risk Analysis** button. The **Risk Analysis [Batch Mode]** dialog box will be displayed. Set your options, and click **OK**.

If a project is closed, Open Plan will open it in **Exclusive** mode, perform the process, save the changes, and then close the project. If a project cannot be opened in **Exclusive** mode (because another user has it open in **Exclusive** or **Shared** mode), it will be skipped.

If you have a project open when the batch process is run, risk analysis will be performed on the project, but the changes will not be saved and the project will remain open. You must manually save the changes yourself.



Risk analysis for multiple projects can also be run by selecting a group of projects and clicking the **Risk Analysis** button on the toolbar. See the previous section for toolbar procedures.



Open Plan creates one risk analysis session log, listing the project results in the order in which the projects were processed in the batch.

Interpreting the Results of Risk Analysis

Once the risk analysis is complete, Open Plan stores the following statistical information about each activity:

- Mean and standard deviation of:
 - Early start date
 - Late start date
 - Early finish date
 - Late finish date
- Mean and standard deviation of:
 - Total float
 - Free float
- Criticality index

This information appears in a risk spreadsheet view:

Activity ID	Activity Desc.	Mean Early Start	Mean Early Finish	Std. Dev. of Early Start	Std. Dev. of Early Finish	Mean Late Start	Mean Late Finish	Std. Dev. of Late Start	Std. Deviation of Late Finish
1	Environmental Management System	02Jan04	18Jan06	0	306t	02Jan04	18Jan06	479t	306t
1.01	Requirements Development	02Jan04	05Feb04	0	463t	02Jan04	06Feb04	479t	71R
1.01.01	Requirements Coordination & Planning	05Feb04	05Feb04	463t	463t	06Feb04	06Feb04	71R	71R
1.01.02	Site Management	02Jan04	05Feb04	0	463t	02Jan04	06Feb04	479t	71R
1.02	Coordination Planning	05Feb04	18Mar04	463t	691t	06Feb04	19Mar04	71R	87R
1.02.01	Engineering Field Testing	05Feb04	25Feb04	463t	557t	06Feb04	26Feb04	71R	761t
1.02.02	System Integration	25Feb04	18Mar04	557t	691t	26Feb04	19Mar04	761t	87R
1.03	Environmental Package System	18Mar04	16Aug04	691t	1499t	19Mar04	17Aug04	87R	1629t
1.03.01	Chemical & Mineralogical Survey	18Mar04	25Mar04	691t	817t	19Mar04	26Mar04	87R	987t
1.03.02	Geochemical Properties	25Mar04	23Apr04	817t	877t	26Mar04	26Apr04	987t	1023t
1.03.03	Spent Fuel Modeling	25Mar04	02Jun04	817t	1493t	14Apr04	22Jun04	2285t	193R
1.03.04	Spent Fuel Tests	02Jun04	28Jul04	1493t	1853t	22Jun04	17Aug04	193R	1629t
1.03.05	Research Integration Model	23Apr04	07May04	877t	921t	26Apr04	10May04	1023t	1049t
1.03.06	Thermodynamic Data Research	07May04	09Jun04	921t	103R	10May04	10Jun04	1049t	1159t
1.03.07	Design, Fabrication Prototype	09Jun04	16Aug04	103R	1499t	10Jun04	17Aug04	1159t	1629t
1.04	Environmental Package Design Specifications	16Aug04	29Dec04	1499t	2241t	17Aug04	30Dec04	1629t	2300t
1.04.01	Environmental Package Design Construction	16Aug04	11Nov04	1499t	2098t	17Aug04	12Nov04	1629t	2167t
1.04.02	Container Fabrication Development	11Nov04	29Dec04	2098t	2241t	12Nov04	30Dec04	2167t	2300t
1.05	Site Investigations	29Dec04	11Mar05	2241t	2452t	30Dec04	14Mar05	2300t	2510t
1.05.01	Site Investigation Integration	29Dec04	31Dec04	2241t	2241t	30Dec04	03Jan05	2300t	2300t
1.05.02	Surface Test Coordination	31Dec04	12Jan05	2241t	2250t	03Jan05	13Jan05	2300t	2366t
1.05.03	Field Test Management Support	12Jan05	19Jan05	2250t	2261t	04Mar05	14Mar05	2507t	2510t
1.05.04	Geology	12Jan05	11Mar05	2250t	2452t	13Jan05	14Mar05	2366t	2510t
1.05.05	Minerology & Petrology	12Jan05	18Feb05	2250t	2337t	03Feb05	14Mar05	260R	2510t
1.05.06	Kinetics & Thermodynamics	12Jan05	17Feb05	2250t	2337t	03Feb05	14Mar05	2552t	2510t
1.06	Ambient Stress & Thermal Tests	11Mar05	07Apr05	2452t	41b	01Apr05	28Apr05	3378t	3391t
1.06.01	Thermal & Mechanical Properties	11Mar05	01Apr05	2452t	2456t	01Apr05	22Apr05	3378t	3388t
1.06.02	Laboratory Thermal Tests	01Apr05	07Apr05	3429t	3437t	22Apr05	28Apr05	4746t	4748t
1.07	Seismic Hazards Analysis	11Mar05	29Apr05	2452t	2482t	29Nov05	18Jan06	3062t	3066t
1.07.01	Faulting	11Mar05	13Apr05	2452t	2501t	29Nov05	30Dec05	3062t	302R

The mean value of a distribution is one measure of central tendency and may be roughly thought of as the weighted average of the possible values in a distribution. It is important to remember that the value for standard deviation is not the maximum amount of variation possible in either direction from the mean value. Instead, you can use the standard deviation value as a measure of confidence as follows:

- There is an approximately 68% probability of an outcome occurring that falls within one standard deviation of the mean.
- There is an approximately 95% probability of an outcome occurring that falls within two standard deviations of the mean.
- There is an approximately 99% probability of an outcome occurring that falls within three standard deviations of the mean.

Thus, you could expect with 95% confidence that an activity with a mean early start of May 1 and a standard deviation of six days would start within 12 days of that date.

This technique only provides an approximation of confidence levels. For one thing, the actual distribution is often skewed in one direction or the other, rendering confidence estimates based on mean and standard deviation values less effective. To get a complete picture, an activity should be designated as a key activity as shown in a risk histogram (as described in the next section of this chapter).

It is also possible to show clearly the relationship between criticality index of an activity and the mean and standard deviation of the total float. Activities whose total floats have large standard deviations relative to their means are more likely to be critical than activities with relatively small standard deviations.



Open Plan calculates values for free float and total float based on the project calendar. Depending on the option you select on the **Options** tab of the **Risk Analysis** dialog box, standard deviations for dates can be calculated with or without regard to the activity calendar.

Risk Histograms

A risk histogram view presents the detailed picture of the probability distribution for calculated dates for a key activity. Open a risk histogram view, select a key activity from the project, then select any of the following dates for use in a risk histogram view:

- Early start
- Early finish
- Late start
- Late finish

The following is an example of a risk histogram based on early start dates:

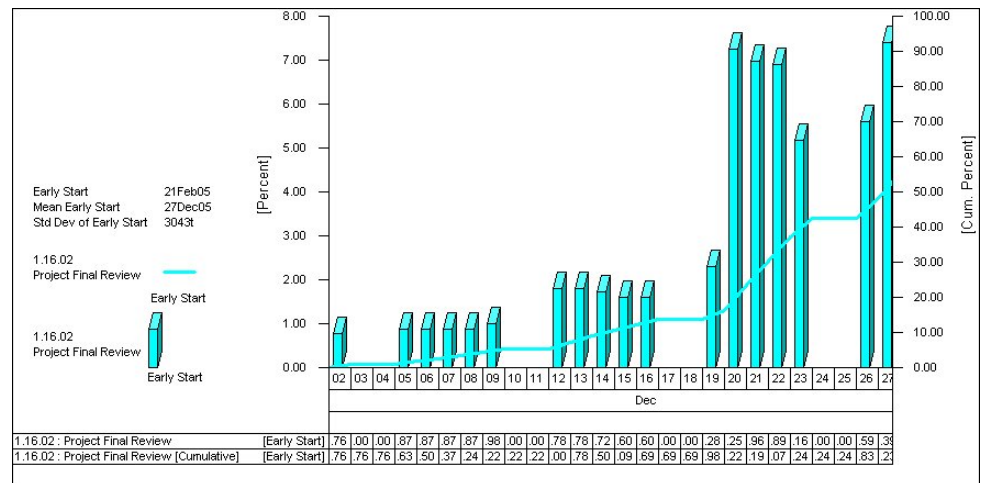

The histogram represents the percentage of trials which resulted in an early start within each time interval. Against the left-hand axis, Open Plan prepares a scale representing the percentage of risk analysis iterations that occurred in a given time interval. In this example, the mode or “most likely” early start for the activity was May 5 with 40% of the simulations falling in that interval.

The right-hand axis represents the cumulative distribution of the dates. In this example, we can see that 50% of the simulations resulted in dates no later than May 5, making it the median early start date.

Notice also how Open Plan displays the following information to the left of the histogram:

- The early and late start dates (calculated by time analysis)
- The mean early and late start dates
- The standard deviation for the mean early start
- The standard deviation for the mean late start

16

Status Information

➤ Overview	359
➤ Project Baselines	360
➤ Activity Progress	369
➤ Resource and Cost Progress	375
➤ Calculating Activity Progress Automatically	379
➤ Calculating Resource Progress Automatically	383
➤ Calculating Earned Value Progress Automatically	386
➤ Progress Dates	388

Overview

The progressing function in Open Plan allows you to enter status information about both activities and resources in a project that is underway. For activities, you can enter actual start and finish dates, estimates of remaining durations, and completion status. For resources, you can enter actual dates, costs, and quantities as well as estimates of future usage.

This chapter starts with discussions on creating and managing project baselines, and then provides discussions of the following topics:

- Entering activity progress information
- Entering resource progress information
- How Open Plan uses progress information when calculating schedules

The chapter concludes with a discussion of the automatic progressing features in Open Plan.

Project Baselines

Baselines provide a “snapshot” of project status by storing a complete set of project data for a specific point in time. By comparing baseline schedules and costs with current information, you can see the areas of the project that are deviating from the original plan. In many cases, project baselines serve as the basis of contractual agreements related to project performance.

Open Plan allows you to store multiple project baselines so that you can, for example, create a baseline each time a major re-planning of the project occurs. For some planners, a single baseline is sufficient for determining subsequent project performance. Other planners prefer to create new baselines on a regular basis in order to maintain a historical record of changes over the life of the project.

Open Plan also allows you to create a performance measurement baseline (PMB) that is used for cost calculations.

Creating a Baseline

You can create a project baseline at any time. Typically, you might create a baseline after the initial plans are complete, but before you begin entering progress information. To create a baseline, use the **Baselines** command from the **Project** menu to display the following dialog box:

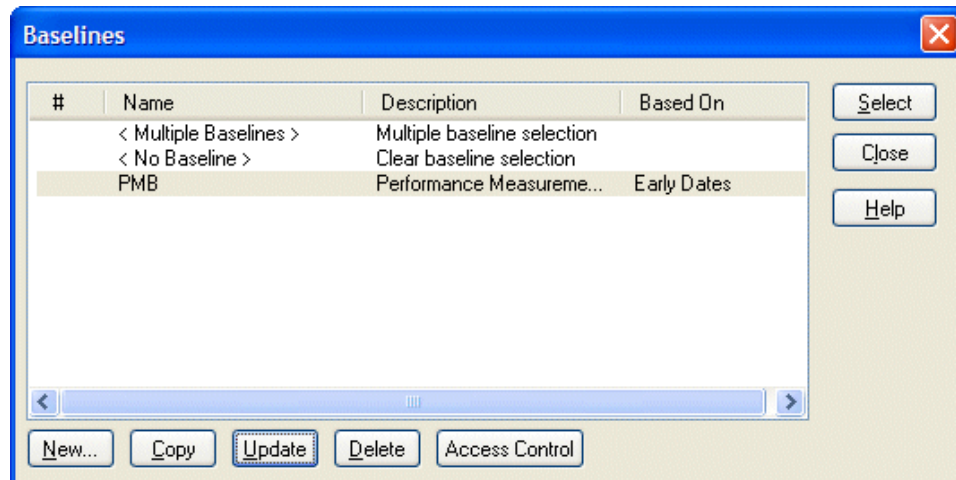

You can also display the **Baselines** dialog box by clicking **Select Baseline** on the **Summary** tab of the **Project Properties** dialog box.

When you indicate that you want to create a new baseline, Open Plan displays the following dialog box:



If a performance measurement baseline (PMB) does not already exist, Open Plan asks if you want to create one. Clicking **Yes** displays the **Add Baseline** dialog box. If the PMB exists, is always used for cost calculations regardless of whether it is selected. If it does not exist, the currently selected baseline is used for cost calculations. If multiple baselines are selected, Open Plan uses the first selected baseline. (Refer to the next section for more information on selecting multiple baselines.)

Use this dialog box to enter the following information about the new baseline:

- **Name** — The name of the baseline.
- **Description** — A description for the baseline.
- **Based On** —You must indicate whether you want to use Early, Late, or Scheduled dates for storing information related to resources and costs. The choice you make determines which set of dates Open Plan stores in the **Baseline Start** and **Baseline Finish** fields for the baseline.

The **Baseline Start** and **Baseline Finish** fields serve as base dates for the calculation of earned value costs – BCWS, ACWP, and BCWP.



Unless you have performed resource scheduling on the project, the Scheduled option is not displayed in this field.



For information about earned value calculations in Open Plan, refer to Chapter 10, “Cost Information.”

- **Ignore Progress, Use Original Project Start Date** — When selected, this option creates baseline dates by performing a time analysis from the project start date.
- **Use Baseline of Same Name on External Subprojects.** — This option is enabled only when you are adding a new baseline.

If the master project and its external subprojects contain a baseline with the same name, then selecting this option instructs Open Plan to use the external subprojects' baseline when performing calculations.

If the this option is selected and the external subprojects do not contain a baseline with the same name as the master project's baseline, then Open Plan will create baselines for the external projects with that name.

The **Filter** section contains the following fields and options:

- **Filter** — You can specify a filter to limit the baseline to a defined group of activities. To limit the scope of the operation, you can either select an existing filter or create a new filter by clicking the **ellipsis** displayed next to the **Filter** text box.



For information about defining filters, refer to Chapter 23, "Project Utilities."

- **Include In-Progress Activities** — If selected, this option includes in-progress activities in the baseline as well as enabling the **Baseline Dates** option.
- **Include Complete Activities** — If selected, this option includes complete activities in the baseline as well as enabling the **Baseline Dates** option.
- **Update Activities Already in Baseline** — This option is enabled only when you are updating a baseline and allows you to control the action that Open Plan should take for activities already in the baseline that you are updating:
 - If this option is selected, Open Plan adds baseline information not only for new activities but for activities already present in the baseline as well.
 - If this option is not selected, Open Plan adds baseline information for only new activities (that is, activities missing from the original baseline).



Selecting this option in conjunction with the Include In-Progress Activities option and/or the Include Complete Activities option enables the Keep Existing Baseline Dates option.

The **Planned Activities** section contains the following option:

- **Use Resource Remaining Quantity Instead of Budget Quantity** — If selected, this option creates baseline activity resource requirements from the remaining resource requirements instead of the budget resource requirements for activities that are not in-progress or complete.



This option is not available when the baseline is based on Schedule Dates.

The **In-Progress and Complete Activities** section contains two subsections:

- **Baseline Dates** (available only when copying or updating existing baselines).

- **Keep Existing Baseline Dates** — This option is enabled when the Update Activities Already in Baseline option is selected in conjunction with the Include In-Progress Activities option and/or the Include Complete Activities option. Selecting the Keep Existing Baseline Dates option instructs Open Plan not to modify the baseline dates of in-progress or completed activities that already exist in the baseline. Baseline resource usage will be updated. If any of these dates are outside the existing baseline dates, the activity's baseline dates will be modified to include the baseline usage.
- **Update Baseline Dates with Current Plan Dates** — This option is enabled only when you are updating a baseline and allows you to control the action that Open Plan should take for activities already in the baseline that you are updating:
 - If this option is selected, Open Plan adds baseline information not only for new activities but for activities already present in the baseline as well.
 - If this option is not selected, Open Plan adds baseline information for only new activities (that is, activities missing from the original baseline).



Selecting this option in conjunction with the Include In-Progress Activities option and/or the Include Complete Activities option enables the Keep Existing Baseline Dates option.

The following two options are enabled only on the **Update Baseline** dialog box:

- **Roll-up Data to All Baseline Parents** — This option is enabled only when you are updating an existing baseline. If selected, this option rolls up all dates, budget cost, and labor quantity data in the baseline to its parent level.
- **Delete All Activities no Longer in Current Project** — This option is enabled only when you are updating an existing baseline. If selected, this option compares the baseline project with its current counterpart and deletes any activities from the baseline that no longer exist in the current project.



Open Plan uses the appropriate project calendar when calculating baseline start dates based on progress information.

Once you create a baseline, you can update it with the current project information at any time. When updating an existing baseline, you can have Open Plan update information for activities already present in the baseline as well as for new activities (that is, activities missing from the original baseline).

You can also create a copy of a baseline by clicking **Copy** on the **Baselines** dialog box. When the **Copy Baseline** dialog box appears, the baseline is given the name **COPY_<baseline name>**. You are able to change the name as well as the description if you so desire. You cannot, however, change the dates that the baseline is based on.

To create a baseline

1. Select the appropriate project, and take one of the following actions:
 - On the **Project** menu, click **Baselines**.
 - On the **Summary** tab of the **Project Properties** dialog box, click **Select Baseline**.
2. On the **Baselines** dialog box, click **New**.

3. On the **Add Baseline** dialog box, enter the information for the baseline, and click **OK**.

To copy a baseline

1. Select the appropriate project, and take one of the following actions:
 - On the **Project** menu, click **Baselines**.
 - On the **Summary** tab of the **Project Properties** dialog box, click **Select Baseline**.
2. From the **Baselines** dialog box, select the baseline to copy, and click **Copy**.
3. On the **Copy Baseline** dialog box, enter a new name and description for the baseline if you so desire, and click **OK**.



If you rename the baseline copy to the name of an existing baseline, Open Plan displays the **Overwrite Existing Baseline** dialog box. Click **OK** to overwrite the existing baseline.

To update a baseline

1. Select the appropriate project, and take one of the following actions:
 - On the **Project** menu, click **Baselines**.
 - On the **Summary** tab of the **Project Properties** dialog box, click **Select Baseline**.
2. From the **Baselines** dialog box, select the baseline that you want to update, and click **Update**.
3. On the **Update Baseline** dialog box, update the information for the baseline, and click **OK**.

Defining Access Rights to a Baseline

You can define the access rights to a baseline for which you are the “owner.” By default, the owner of a file is the user who creates the file. By creating the file, the owner is automatically given full read/write access rights to the data and can grant rights to other users.



For information on defining access rights to projects, resource files, calendar files, code files, and view templates, refer to Chapter 24, “System Utilities.”

When you select a baseline on the **Baselines** dialog box and click **Access Control**, the following dialog box is displayed:

Group	User ID	Copy	Delete	Update	View
WORLD		No	No	No	Yes

You can use the following fields to define access rights to the baseline:

- **Group** — This field allows you to grant access rights to an entire user group. User groups are created within WelcomSecurity.
- **User ID** — This field allows you to grant access rights to individual users. User IDs are created within WelcomSecurity.
- **Copy** — This field controls whether the group or user has the right to copy the baseline.
- **Delete** — This field controls whether the group or user has the right to delete the baseline.
- **Update** — This field controls whether the group or user has the right to update the baseline.
- **View** — This field controls whether the baseline is included on the Baselines dialog box for the group or user.

To define access rights to a baseline



You must be the owner of the baseline or have SYSADMIN rights in order to define access rights to it.

1. Select the project that contains the baseline to which you want to define access rights.
2. Take one of the following actions:
 - On the **Project** menu, click **Baselines**.
 - On the **Summary** tab of the **Project Properties** dialog box, click **Select Baseline**.
3. From the **Baselines** dialog box, select the baseline, select the appropriate baseline, and click **Access Control**.
4. On the **Baseline Access Control** dialog box, assign access rights to the baseline.
5. When finished, click **OK**.

Managing Baselines

Although your project can have more than three baselines, Open Plan allows up to three baselines to be available for reporting purposes at a time. You also can change the current baseline(s) at any time.

The **Summary** tab of the **Project Properties** dialog box displays the current baseline(s) selected for the project:

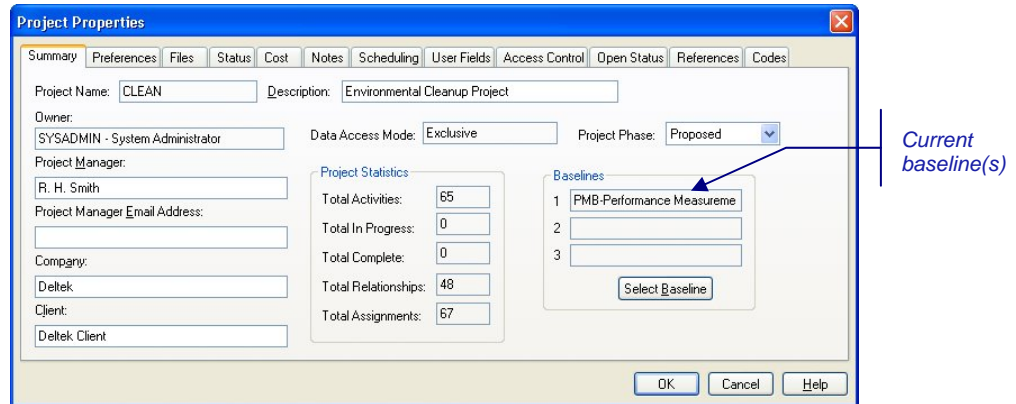

When you select **<Multiple Baselines>** from the **Baselines** dialog box, Open Plan displays the following:

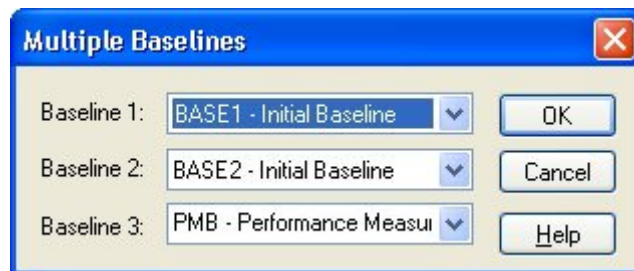

For information on displaying the **Baselines** dialog box, refer to the previous section in this chapter.

You can use this dialog box to select up to three baselines for the project. If the PMB does not exist, Open Plan uses the first selected baseline for cost calculations when you have multiple baselines selected.

If you are not interested in having access to baseline information, you can also specify that no baseline should be loaded with the project. This has the effect of reducing the memory requirements of a project, and thus has the potential of improving performance.

It is also possible to delete unneeded project baselines, which can help reduce the overall size of the project data file.

To select a single current baseline

1. Select the appropriate project, and take one of the following actions:
 - On the **Project** menu, click **Baselines**.
 - On the **Summary** tab of the **Project Properties** dialog box, click **Select Baseline**.

- From the **Baselines** dialog box, select the baseline that you want as the current baseline.

If you do not want to load a baseline at this time, select **<No Baseline>** from the list.

- Click **Select**.

To select multiple current baselines

- Select the appropriate project, and take one of the following actions:
 - On the **Project** menu, click **Baselines**.
 - On the **Summary** tab of the **Project Properties** dialog box, click **Select Baseline**.
- From the Baselines dialog box, select **<Multiple Baselines>**.
Open Plan displays the **Multiple Baselines** dialog box.
- Select up to three baselines, and click **OK**.

To delete a baseline

- Select the appropriate project, and take one of the following actions:
 - On the **Project** menu, click **Baselines**.
 - On the **Summary** tab of the **Project Properties** dialog box, click **Select Baseline**.
- Select the baseline that you want to delete, and click **Delete**.
- When Open Plan asks you to confirm the deletion, click **Yes**.

Using Baseline Information

Once you have loaded the baseline(s) for a project, you can access baseline fields just as though they were part of the standard project database. To use these fields in a view, select a baseline field (identified by the name of the current baseline) from the list of available field names:

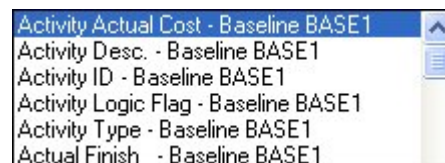

When selecting fields, you can choose which of the current baselines you want to display. In a multi-table view, you can link to all the current baselines and display the data for each on different rows.

In resource histogram views, you can display baseline resource assignments. These assignments are based on either early, late, or scheduled dates, depending on which dates were used to create the baseline. If you are displaying the results of earned value calculations, the calculations of BCWP and BCWS are based on the **Baseline Start** and **Baseline Finish** fields stored with the baseline.



If it exists, the performance measurement baseline (PMB) is always used for the calculation of budget value regardless of whether it is selected or not.

You can also use baseline fields in filters, sorts, and calculated field expressions. Keep in mind, however, that the values of baseline fields depend on which baseline is currently loaded for a project and cannot be edited from within the view.



A common issue in many reports showing baseline information is that the set of activities stored in the baseline no longer matches the set currently defined in the project. For example, the baseline can include records of activities that were deleted in the project after the baseline was created. It is also possible to have activities in the project that were added since the last time the baseline was updated. In spreadsheet, barchart, and network views, therefore, baseline data appears only in cases where an activity exists in both the baseline and the current project. In resource histogram views, on the other hand, the resource and cost totals are based on all activities stored in the baseline, even if they no longer exist in the current project.

Activity Progress

In general, entering status information about activity progress consists of specifying the following information so that a revised time analysis of the project can be performed:

- Has the activity started? If so, when?
- Has the activity ended? If so, when?
- If the activity has started but not yet ended, how long is the remaining duration?

It is important to make sure that all progress information up to Time Now has been entered. The Time Now date (sometimes referred to as the status date) refers to the date for which all the progress data in a project has been reported. Open Plan assumes that no future work for the project (including activities which have not yet started and activities which have been started but not completed) can be scheduled prior to the Time Now date. For example, a Time Now of 01Jun06 means that all progress data in the project up to and including 31May06 has been reported, and that Open Plan does not schedule any work for the project prior to 01Jun06.



Time Now is a date for statusing purposes only and does not have any relationship to the actual current calendar date.

It is recommended that you enter actual dates for progressed activities whenever possible. If you omit an actual start or actual finish date when entering project progress, Open Plan deduces the dates for the purposes of internal calculations based on the status code entered and Time Now.



One proven way to gather progress information in a systematic fashion is to work from a turnaround report created especially for the managers responsible for those particular activities. The managers can use this document to enter their progress against a list of activities scheduled to be in progress during a particular time period.

Entering Activity Progress

To enter progress information in Open Plan, you can use the **Activity** tab of the **Activity Progress** dialog box. You can display this dialog box in three ways:

- By clicking the **Progress** button on the **Activity Details** dialog box
- By selecting an activity and clicking **Progress** on the **Edit** menu in any activity view
- By right-clicking an activity and clicking **Progress** on the context menu.

This dialog box displays the original duration of the activity along with the current date of Time Now and the current status of the activity. You can also enter the following additional progress information using this dialog box:

- **Actual Start** — You can enter an actual start date for the activity. (Note that entering an actual start date automatically changes the activity status from planned to in-progress.)
- **Actual Finish** — You can indicate that the activity is complete by changing the activity status to complete or by entering an actual finish date. If you enter an actual finish date without changing the activity status, Open Plan treats the activity as complete during time analysis.
- **Expected Finish** — You can describe the status of an activity by entering an expected finish date. In this case, the remaining duration of the activity is calculated by Open Plan based on the difference between that date and Time Now. If you enter an expected finish date that implies a start date before Time Now, Open Plan treats the activity as in-progress during time analysis.



If you enter both an actual and an expected finish date for an activity, Open Plan ignores the expected finish date except in cases where the actual finish date is after Time Now.

- **As Planned** — You can indicate that the activity is progressing according to plan. (Notice, however, that Open Plan does not progress activities automatically unless you enter an actual start date.)
- **Remaining Duration** — You can enter the remaining portion of the activity duration.
- **Elapsed Duration** — You can enter an elapsed duration since the start of the activity.
- **Percent Complete** — You can enter a completion estimate as a percentage.
- **Complete** — You can indicate that the activity is complete.

Like the **Activity Details** dialog box, the **Activity Progress** dialog box is modeless, which allows you to keep it open while performing other operations in Open Plan. The navigation buttons and the **Close**, **Undo**, and **Apply** commands

function identically to their counterparts in the **Activity Details** dialog box. You can, in fact, keep both the **Activity Details** dialog box and the **Activity Progress** dialog box open at the same time, updating the information in either dialog box as appropriate.

By default, Open Plan synchronizes multiple activity dialog boxes so that using the navigation buttons on one dialog box will result in Open Plan scrolling to the appropriate activity on another dialog box.



For information about disabling this feature, refer to Chapter 25, "System Defaults."

To enter progress for an activity

1. In an activity view, select the activity for which you want to enter progress information.
2. Take one of the following actions:
 - On the **Edit** menu, click **Progress**.
 - Right-click the activity, and click **Progress** on the context menu.
 - Double-click the activity, and click **Progress** on the **Activity Details** dialog box.
3. On the **Activity** tab of the **Activity Progress** dialog box, enter the progress information for the activity, and click **Close**.

Entering Progress in a Spreadsheet View

To facilitate the entry of progress information for multiple activities, Open Plan provides a standard progress spreadsheet view that you can use to enter any progress information:

Activity ID	Activity Desc.	Dur.	Early Start	Actual Start	Actual Finish	Progress Type	Progress Value	Remaining Dur.	Accomplished_Duration
1	Environmental Management System	572d	02Jan03			Planned	0	572d	0
1.01	Requirements Development	54d	02Jan03			Planned	0	54d	0
1.01.01	Requirements Coordination & Planning	30d	05Feb03			Planned	0	30d	0
1.01.02	Site Management	24d	02Jan03			Planned	0	24d	0
1.02	Coordination Planning	29d	19Mar03			Planned	0	29d	0
1.02.01	Engineering Field Testing	13d	19Mar03			Planned	0	13d	0
1.02.02	System Integration	16d	07Apr03			Planned	0	16d	0
1.03	Environmental Package System	131d	29Apr03			Planned	0	131d	0
1.03.01	Chemical & Mineralogical Survey	3d	29Apr03			Planned	0	3d	0
1.03.02	Geochemical Properties	50d	02May03			Planned	0	50d	0
1.03.03	Spent Fuel Modeling	50d	02May03			Planned	0	50d	0
1.03.04	Spent Fuel Tests	38d	11Jul03			Planned	0	38d	0
1.03.05	Research Integration Model	10d	11Jul03			Planned	0	10d	0
1.03.06	Thermodynamic Data Research	22d	25Jul03			Planned	0	22d	0
1.03.07	Design, Fabrication Prototype	46d	26Aug03			Planned	0	46d	0
1.04	Environmental Package Design Specifications	92d	29Oct03			Planned	0	92d	0
1.04.01	Environmental Package Design Construction	60d	29Oct03			Planned	0	60d	0
1.04.02	Container Fabrication Development	32d	23Jan04			Planned	0	32d	0
1.05	Site Investigations	50d	09Mar04			Planned	0	50d	0
1.05.01	Site Investigation Integration	2d	09Mar04			Planned	0	2d	0
1.05.02	Surface Test Coordination	8d	11Mar04			Planned	0	8d	0
1.05.03	Field Test Management Support	5d	23Mar04			Planned	0	5d	0
1.05.04	Geology	40d	23Mar04			Planned	0	40d	0
1.05.05	Minerology & Petrology	26d	23Mar04			Planned	0	26d	0
1.05.06	Kinetics & Thermodynamics	26d	23Mar04			Planned	0	26d	0
1.06	Ambient Stress & Thermal Tests	18d	18May04			Planned	0	18d	0
1.06.01	Thermal & Mechanical Properties	14d	18May04			Planned	0	14d	0
1.06.02	Laboratory Thermal Tests	6d	05Jun04			Planned	0	6d	0
1.07	Seismic Hazards Analysis	34d	18May04			Planned	0	34d	0
1.07.01	Faulting	22d	18May04			Planned	0	22d	0
1.07.02	Hydrology	8d	17Jun04			Planned	0	8d	0

When entering progress information using this view, note that the setting of the **Progress Type** field determines how Open Plan interprets the **Progress Value**

field. For example, if you entered **Percent Complete** for the **Progress Type** field, Open Plan interprets the **Progress Value** field as a percentage.



The **Accomplished Duration** and **Remaining Duration** fields are calculated by Open Plan and cannot be modified by the user.

Entering Progress in a Barchart View

It is possible to status an activity displayed in a barchart view by manipulating the bar. By dragging the cursor from the start of the bar toward the end of the bar, you can indicate how much of the activity is complete.

For a bar to be eligible for manipulation, the bar type must display early dates and must have the **Drag** option set to **Yes**. These settings are defined in the **Bar Types** dialog box.



For information about defining activity bar types, refer to Chapter 18, “Barchart Views.”



Bar Data Mode
button



Progress cursor

To enter activity progress in a barchart view

1. Verify that the view is in the bar data mode by taking one of the following actions:
 - On the **View** menu, select **Bar Data Mode**.
 - On the toolbar, click the **Bar Data Mode** button.
2. Position the cursor to the left of the activity bar.
3. When the cursor changes shape to a progress arrow, drag to the right to indicate the percentage completion of the activity.

Viewing Project Progress Information

You can display project information at any time by opening a project and issuing the **Properties** command. The **Status** tab of the **Project Properties** dialog box displays a summary of the current project status:

Project Properties

Summary | Preferences | Files | **Status** | Cost | Notes | Scheduling | User Fields | Access Control | Open Status | References | Codes

Project Name: CLEAN Description: Environmental Cleanup Project

Status

Status: Planned

Min. Total Float: 0

Early Finish: 15Mar05

Late Finish: 15Mar05

Scheduled Finish: 15Mar05

Project Dates

Project Start: 01Jan03 00:00

Time Now: 01Jan03

Target Start:

Target Finish:

Finish Type: None

OK Cancel Help

You can also use this tab to enter information about the project such as Time Now or project target dates and types.



For information about these fields, refer to Chapter 5, "File Properties."

Any progress information you enter will have no effect on this summary until you recalculate the project schedule using time analysis.

To view project progress information

1. Select the appropriate project.
2. Take one of the following actions:
 - On the **Project** menu, click **Properties**.
 - Right-click the project folder, and click **Properties** on the context menu.
3. On the **Project Properties** dialog box, click the **Status** tab.



You can view the **Project Properties** dialog box without having to first open the project.

The Effect of Activity Progress Information

Once you have entered progress for activities, you can calculate new early start/finish and late start/finish dates using time analysis and new scheduled start/finish dates using resource scheduling.



After progressing the activities, if you run resource scheduling without first running time analysis, the scheduled start and finish dates calculated will be inaccurate.

The following guidelines explain how Open Plan uses the progressing information when it calculates the new schedule.

- If an activity has an actual start date but no other indication of activity status, Open Plan deduces the elapsed duration of the activity by comparing the actual start date to the Time Now date.
- If activity status and progress information imply that the activity is complete (for example, if the elapsed duration of the activity exceeds its total duration), Open Plan assumes that the activity is complete.
- If an activity has out-of-sequence progress (that is, progress has been reported even though activities deemed as predecessors in project logic have not been completed), Open Plan accepts the information but issues a warning in the time analysis session log.
- Open Plan ignores actual dates later than Time Now (although a warning is issued in the session log).
- Open Plan calculates progress on a subproject from progress entered at the activity level. Open Plan ignores any progress entered at the subproject level.
- After evaluating the progress information, Open Plan calculates the early and late dates for the remaining portion of the activity duration only. (Completed

activities have their late dates calculated as though the activity duration was zero.) This convention allows Open Plan to retain the maximum information for reporting purposes, including tracing out-of-sequence progress.



For a more complete discussion about how Open Plan interprets progress information, refer to Chapter 9, “The Effect of Progress Information,” in the *Deltek Open Plan Developer’s Guide*.

Resource and Cost Progress

In addition to entering information about the schedule status of activities, you can enter information about resource costs, usage, and forecasts. Open Plan uses this information to calculate project costs that can be displayed in views such as a cost histogram. If you enter a value for the physical completion of an activity, you can also use this cost information to calculate the earned value of a project.

Open Plan does not restrict you to entering progress for budgeted resources only. For example, assume that you planned to use one resource for an activity but actually used another. Instead of returning to the original assignment, deleting it, and entering an assignment for the new resource, you can simply set the remaining quantity of the original assignment to the appropriate level and enter progress information for the unbudgeted resource.

You can also enter costs that are not associated with any resource. Entering costs not associated with a resource allows you to define costs at the activity level. These costs can be reported separately from the costs you have entered at the resource level.

You can make as many entries for a specific resource as you wish. Each entry consists of a date or a pair of dates defining the period for the cost and then the actual usage or costs. It is also possible to enter a forecast of remaining usage for a resource. Once you enter progress for a resource and save your changes, Open Plan automatically rolls up the information for the resource, displays the results in the **Previous** fields, and clears the entry fields.

To enter resource progress information in Open Plan, use the **Resources** tab of the **Activity Progress** dialog box. You can display this dialog box by selecting an activity and clicking **Progress** on the **Edit** menu in any activity view or by right-clicking an activity and clicking **Progress** on the context menu.

Resource	Phy. %	Actual	Remaining	Previous	Budget
RES.LAB.ENG.MECH.IKE	0.00 Qty		60.00	0.00	60.00
(Ike Hamlin)	Cost		2700.00	0.00	2700.00

If you scroll through the fields displayed in this dialog, you can see the current actual costs and usage for each resource as well as the budgeted costs and units for all assigned resources. Budgeted costs of resources reflect any cost escalations defined for the resource based on the period of the original assignment.

This dialog contains the following elements:

- **Activity Physical % Complete** — An estimate of the percent of the work of the activity that is complete.



Changing the **Activity Physical % Complete** triggers a recalculation of the resource physical percent complete. When you tab out of this field, the numbers automatically update.

For example, assume that the activity consists of paving a 5-mile stretch of road. When the first mile has been paved, you could enter 20 in this field to indicate that the work of the activity is 20% complete. This information is completely independent of the amount of the activity duration that has elapsed.



Open Plan uses the information from this field to calculate earned value (budgeted cost of work performed or BCWP) and does not affect any subsequent time analysis or resource scheduling calculations.

- **Start Date** — The start of the period covered by the actuals entered. The date in this field applies to all of the resource progress records entered during the current session.
- **End Date** — The end of the period covered by the actual quantity and actual cost values entered. If a date is entered in this field, the actual values are spread between the start and end dates. If this field is left blank, the actual values are applied on the start date. The date in this field applies to all the resource progress records entered during the current session.
- **Resource** — Each resource assigned to the activity is identified on two lines in this column.
 - On the first line, Open Plan displays the ID of the resource.
 - On the second line, Open Plan displays the description associated with the resource ID.

In addition, you can enter valid resource IDs in blank rows at the bottom of the table to indicate actual quantity and actual cost for unbudgeted resources. You can also enter actuals on a row that does not contain a resource ID to have Open Plan roll up the actuals to the activity directly.



If you indicated that Open Plan should use activity progress information to automatically calculate resource progress, you cannot enter progress information for a budgeted resource. For more information about the automatic calculation of resource progress, refer to the “Calculating Resource Progress Automatically” section in this chapter and also Chapter 7, “Resource Definitions.”

- **Phy. %** — Open Plan displays the resource physical percent complete in this field. This is the amount of the activity’s requirement for that resource that has been used.

Adjusting this value triggers a recalculation of the **Activity Physical % Complete**. When you tab out of this field, the numbers automatically update.



For detailed information on how Open Plan calculates the physical percent complete at both the activity level and resource level, refer to Chapter 12, “Cost Calculations,” in the *Deltek Open Plan Developer’s Guide*.

- **Actual** — This column controls the following types of data:
 - **Qty** — The actual quantity of the resource used during the period defined by the start and end dates. You can enter actual quantity information for some resources and have Open Plan calculate the actual quantity based on activity progress (by selecting that option on the **Resource Details** dialog box) for others.



You cannot enter actual quantity information for a resource for which resource progress is automatically calculated based on activity progress. (This setting is defined on the **General** tab of the **Resource Details** dialog box.)

- **Cost** — The actual cost of the quantity of the resource used. You can enter actual costs directly for some resources and have Open Plan calculate the actual cost based on progressed quantity (by selecting that option on the **Resource Details** dialog box) for others.



You cannot enter actual cost information for a budgeted resource for which actual cost is automatically calculated based on progressed quantity. For more information about the automatic calculation of resource progress, refer to Chapter 7, “Resource Definitions,” and the “Calculating Resource Progress Automatically” section in this chapter.

- **Remaining** — This column controls the following types of data:
 - **Qty** — When you tab to this field from the actual quantity field, Open Plan calculates the remaining quantity for resources assigned to the activity by subtracting the actual quantity from the quantity of the original resource assignment. You may overwrite the value displayed in this field. Open Plan ignores this value for unbudgeted resources or for costs entered at the activity level without reference to a resource.

The remaining quantity can never be less than zero. Therefore, if you have entered an actual quantity that is greater than the original resource assignment, Open Plan reports that the remaining quantity is zero.



If you have decided not to use a resource assigned to the project, overwrite the remaining resource assignment calculated by Open Plan with a zero.

- **Cost** — When you tab away from the **Actual Cost** field, Open Plan displays the remaining resource cost. Open Plan calculates this value as follows:

$$\text{Budget Cost} - \text{Previous Cost}$$

This value is calculated only for display purposes and is not stored in the database.



Since Open Plan ignores this value for unbudgeted resources or for costs entered at the activity level without reference to a resource, it is important to adjust the remaining quantities of budgeted but unused resources in cases where you have substituted unbudgeted resources or activity-level costs.

- **Previous** — This column displays the following types of data:
 - **Qty** — Open Plan displays the sum of all the actual quantity records for the resource entered or calculated during previous sessions.
 - **Cost** — Open Plan displays the sum of all the actual cost records for the resource entered or calculated during previous sessions.
- **Budget** — This column displays the following types of data:
 - **Qty** — Open Plan displays the budget quantity for the resource calculated from the resource assignment records.
 - **Cost** — Open Plan displays the escalated value of the resource's budget cost in this cell.

To enter resource progress for an activity

1. Select the activity for which you want to enter progress information.
2. Take one of the following actions:
 - On the **Edit** menu, click **Progress**.
 - Right-click the activity, and click **Progress** on the context menu.
 - Double-click the activity, and click **Progress** on the **Activity Details** dialog box.
3. On the **Activity Progress** dialog box, click the **Resources** tab.
4. Enter the dates for the progress information to be entered during this session.
5. Enter the resource progress information for the activity, and click **Apply**.

Open Plan responds by rolling up the information for the resource, displaying the results in the **Current Cost** and **Current Quantity** fields, and clearing the entry fields.

Calculating Activity Progress Automatically

The automatic progressing feature in Open Plan allows you to advance Time Now and update the status information for all the activities of a project in a single operation. You must have performed time analysis on the project at least once before Open Plan can calculate activity progress automatically.

Open Plan can automatically generate actual start and finish dates and calculate activity progress based on the early or late dates produced by time analysis, the scheduled dates produced by resource scheduling, or baseline dates. For in-progress activities, you can have Open Plan automatically calculate any of the following measures of progress:

- Remaining duration
- Elapsed duration
- Percent complete
- Expected finish

Typically, project managers might use the automatic progressing feature to calculate status for large projects and then enter information for any exceptions manually. Automatic progressing does not overwrite any existing actual dates, nor does it change the status of an activity marked as complete. However, estimates of progress for in-progress activities may be modified by the operation.

To have Open Plan calculate activity progress automatically, click **Progress Calculations** on the **Project** menu, or click the **Progress Calculations** button on the toolbar to display the following dialog box:

Progress
Calculations button



Normally, you would perform progress calculations before time analysis for the next progressing period. If this is the case, you use this dialog box to set new Time Now values.

Use this dialog box to define the dates that Open Plan should use for calculating progress as well as how in-progress activities should be handled.

You also have the opportunity to set the following options for the operation:

- **Time Now** — By default, the current date populates this field. Click the **ellipsis** to select a different date.
- **Matching Filter** — To limit the scope of the operation, you may select either an existing filter or create a new filter by clicking the **ellipsis** displayed next to the **Matching Filter** text box.



For information about defining filters, refer to Chapter 23, “Project Utilities.”

- **Update Activity Status and Actual Dates** — Selecting this option allow you to specify the following additional options:

- **Based On** — You can specify which of the types of dates Open Plan should use in performing the calculations:
 - Early Dates
 - Late Dates
 - Scheduled Dates
 - Baseline Dates
- **Complete if Finished Before Time Now** — If this option is selected, Open Plan treats the type of dates selected in the Based on field as complete if they finish before Time Now and enters the appropriate (early, late, scheduled, or baseline) finish date into the actual finish date field.



The automatic progress function does not affect any actual finish dates already recorded on complete activities.

- **In Progress if Started Before Time Now** — If this option is selected, Open Plan treats activities that meet all of the following criteria as in progress:
 - Activity starts before Time Now
 - Activity has an early finish date after Time Now
 - Activity is not already marked as complete



The automatic progress function does not affect any actual start dates recorded on activities already statused as in-progress.

For activities that it treats as in-progress, Open Plan allows you to specify which of the following values it should calculate:

- Remaining Duration
 - Elapsed Duration
 - Percent Complete
 - Expected Finish
- **Update Resource Remaining Quantity** — When selected, this option recalculates the remaining resource quantity for each resource assignment for the activity. This option should be selected if you want Open Plan to progress resource assignments for you. Otherwise, if you wish to manually update remaining quantity, clear the option.
 - **Update Resource Actual Quantity** — When selected, this option calculates the actual resource quantity used during the progress period. This will generate a resource Cost record time phased using the Progress Start and End dates defined in the progress calculations dialog. If this option is not selected then actual resource usage will need to be entered manually.
 - **Update Physical Percent Complete**
 - **Base Physical Percent Complete on EVT** — If the Base Physical Percent Complete on EVT option is selected (and only when the option to update physical percent complete is enabled) the Physical Percent calculated will take into account the Earned Value Type (Performance Measurement Type) defined for the activity in the Advanced Tab of the

Activity Details dialog. For example if the EVT is 50/50, then Open Plan will set the Physical Percent Complete to 50% when the activity is started and to 100% when the activity is completed. Otherwise, if this option is not selected, the Physical Percent complete would be derived from Budget versus Remaining hours or time percent complete (if no resources are assigned).

- **Start Date** — The Progress Start Date, together with the End Date, define the period over which any Actual Resource Quantities and costs are spread. Typically, the Progress Start date is the Time Now (status date) from the previous reporting cycle unless a greater degree of detail is required. If more detail is required, it would represent the actual date the resource started to be used and the costs that were incurred.
- **End Date** — The Progress End Date, together with the Start Date, define the period over which any Actual Resource Quantities and Costs are spread. Typically, the Progress End Date is the time period before the Time Now (status date) of the current reporting cycle unless a greater degree of detail is required. If more detail is required, it would represent the date the resources stopped being used and the costs stopped being incurred.

Each time you perform automatic progressing, Open Plan creates a session log file that records any system or error messages issued during the operation. Open Plan saves the file (Opp_prog.log) and allows you to examine its contents at the conclusion of each session.



You must open a project in the exclusive mode to perform automatic progressing.

To calculate activity progress automatically

1. Take one of the following actions:
 - On the Project menu, click Progress Calculations.
 - On the toolbar, click the Progress Calculations button.
2. Enter the information for the operation, and click **OK**.

Open Plan informs you if an error condition is detected during the session. You can use the **Log Viewer** to examine the error in the session log.



For more information on the **Log Viewer**, refer to Chapter 24, “System Utilities.”

Calculating Resource Progress Automatically

If you do not want to enter resource progress manually, you can have Open Plan calculate resource progress automatically based on the current status of the activity. To use this feature, you must first indicate on the **General** tab of the **Resource Details** dialog box that resource progress can be based on activity progress:

The screenshot shows the 'Resource Details [CLEANRES]' dialog box. The 'General' tab is selected. The 'ID' field contains 'RES.LAB.ENG.CIV.MIKE' and the 'Desc' field contains 'Mike Holmes'. The 'Type' is set to 'Normal' and the 'Category' is 'Labor'. The 'Unit' is 'labor-hr' and the 'Effort Factor' is '1'. The 'Unit Cost' is '45' and the 'Employee ID' field is empty. The 'Threshold' is '0' and the 'Project' is '<None>'. The 'Email Address' field is empty. At the bottom, there are three checkboxes: 'Suppress in Lists' (unchecked), 'Suppress for Scheduling' (unchecked), and 'Roll up for Scheduling' (unchecked). There are also three checkboxes on the right: 'Progress Based on Activity Progress' (unchecked), 'Actual Cost Based on Progressed Quantity' (unchecked), and 'Consider in Cost Calculations' (checked). A blue arrow points from the text 'Select to allow automatic resource progressing.' to the 'Progress Based on Activity Progress' checkbox.

Select to allow automatic resource progressing.

After you enter progress information for activities, you can have Open Plan calculate the quantity of resource units that correspond to the recorded activity progress for all eligible resources. For example, if you have indicated that an activity is 50% complete, Open Plan calculates the number of resource units corresponding to the first half of the activity duration, taking into account factors such as spread curves, offsets, and periods, which may affect the distribution of the resource assignment.

To have Open Plan calculate resource progress automatically, click **Progress Calculations** on the **Project** menu, or click the **Progress Calculations** button on the toolbar to display the following dialog box:

 Progress Calculations button

You can update the resource remaining quantity and the resource actual quantity separately or at the same time. Open Plan performs the calculations based on options selected on the **General** tab of the **Resource Details** dialog box for the resources defined as supporting progress calculations in the Resource (OPP_RES) table.

Each time you perform automatic resource progressing, Open Plan creates a session log file that records any system or error messages issued during the operation. Open Plan saves the file (Opp_prog.log) in your Open Plan working directory, and allows you to examine its contents at the conclusion of each session.



To see the results of this calculation, display the **Resources** tab of the **Activity Progress** dialog box.

To calculate resource progress automatically

1. Take one of the following actions:
 - On the Project menu, click Progress Calculations.
 - On the toolbar, click the Progress Calculations button.
2. Enter the dates for the operation, and click **OK**.

Open Plan informs you if an error condition is detected during the session. You can use the **Log Viewer** to examine the error in the session log.



For more information on the **Log Viewer**, refer to Chapter 24, "System Utilities."

Group Processing Resource Progress

You can also perform progress calculations in **Batch Mode**. This allows you to run time analysis for multiple projects at one time. To run progress calculations in **Batch Mode**, select more than one project from the **Details** pane of the Open Plan Explorer, and click the **Progress Calculations** button. The **Progress Calculations [Batch Mode]** dialog box will be displayed. Set your options, and click **OK**.

If a project is closed, Open Plan will open it in **Exclusive** mode, perform the process, save the changes, and then close the project. If a project cannot be opened in **Exclusive** mode (because another user has it open in **Exclusive** or **Shared** mode), it will be skipped.

If you have a project open when the batch process is run, a progress calculation will be performed on the project, but the changes will not be saved and the project will remain open. You must manually save the changes yourself.



Resource progress can be calculated automatically for multiple projects by selecting a group of projects and clicking the **Progress Calculations** button on the toolbar. See the previous section for toolbar procedures.



Open Plan creates one progress calculation session log, listing the project results in the order in which the projects were processed in the batch.

Calculating Earned Value Progress Automatically

You can have Open Plan update the earned value of the project by selecting the **Update Physical Percent Complete** option.

When the **Update Physical Percent Complete** option is selected and the **Base Physical Percent Complete on EVT** option is not selected, Open Plan updates the physical percent complete for activities that match the selected filter based on activity status using the following formula:

$$PPC = (\text{Elapsed duration} / \text{Expected duration}) \times 100$$

Where:

Elapsed duration is calculated as (Time Now – Actual Start)

Expected duration is calculated as (Finish Date – Actual Start Date)



The Finish Date is based on the user's selection of (early, late, or scheduled) dates.

The **Base Physical Percent Complete on EVT** option allows you to use the EVT assigned to the activities on the **Advanced** tab of the **Activity Details** dialog box when updating the physical percent complete.

Progress Dates

The **Start Date** and **End Date** fields are enabled when you choose to update resource progress or earned value.



Open Plan stores the BCWP time-phased. Therefore, you must enter a start date in the **Progress Dates** section of the dialog box.

Open Plan uses the dates to spread actual costs and quantify for the purpose of cost reporting:

- **Start Date** — The start of the period covered by the automatic resource calculation. The date in this field is recorded as the From date on the resource actual quantity/cost record in the cost file.



If the actual start date of the activity is later than the start date defined in this field (but within the Start date – End date range), the activity actual start date is used as the **Start Date** in the progress calculation.

- **End Date** — The end of the period covered by the automatic resource calculation. If a date is entered in this field, the actuals are spread between the start and end dates. If this field is left blank, the actuals are applied on the start date. The date in this field is recorded as the To date on the resource actual quantity/cost record in the cost file.



If the actual finish date of the activity is earlier than the end date defined in this field (but within the Start date – End date range), the activity actual finish date is used as the **End Date** in the progress calculation.

17

Views and Reports

➤ Overview	391
➤ Views.....	392
➤ Custom Symbols	399
➤ Printing Reports	402
➤ Reporting Calendars	415
➤ Notes	418

Overview

Views are the means through which you can add, update, and display information about a project in Open Plan. Although you are free to create as many custom views as you wish, all Open Plan views fall into one of the four following types:

- **Barchart view** — A composite view displaying a barchart, a spreadsheet, and a resource/cost histogram
- **Code view** — A logic diagram of the project codes
- **Network view** — A logic diagram of the project activities and relationships
- **Resource view** — A display of the resource breakdown structure
- **Spreadsheet view** — A display of project information in a tabular format. Spreadsheet views can be based on a single table or on multi-tables.
- **Histogram view** — A display of resource/cost or risk analysis information in a graphical format

This chapter contains discussions of a number of topics related to the reporting of project data in Open Plan:

- Views
- Printing reports
- Reporting calendars

The chapter concludes with a discussion of the notes feature in Open Plan.



For information about features specific to a particular type of view, refer to the appropriate chapter: Chapter 18, “Barchart Views”; Chapter 11, “Project Codes”; Chapter 19, “Network Views”; Chapter 7, “Resource Definitions”; Chapter 20, “Spreadsheet Views”; or Chapter 21, “Histogram Views.”

Views

In the Open Plan Library, views store all the information about how Open Plan should display a particular view. You can customize an existing view and then share the new view with multiple projects. However, since a view is not associated with a specific project, it cannot display data. As a result, before you can open or change its definition, you must first assign it to a project.

When you assign a view to a project, you create a link in the project folder to the view in the Open Plan Library. If you modify the appearance of the view and save the view, your changes may affect other instances of that view.

Working with Views

You can assign a view to a project by using one of the following techniques:

- Drag the view from the Open Plan Library to the appropriate project folder.
- Double-click a view in the Open Plan Library to display a list of the projects that are currently open. Then select one of the projects from the list for the assignment.

Provided that the project to which you want to assign the view is open, Open Plan displays the **Choose a Project** dialog box when you double-click a view in the Open Plan Library. If there are no projects open when you double-click the view, Open Plan informs you that the view is not associated with a project and advises you to drag the view from the library to the project folder to create a link.



A project does not need to be open if you use drag and drop to assign a view.

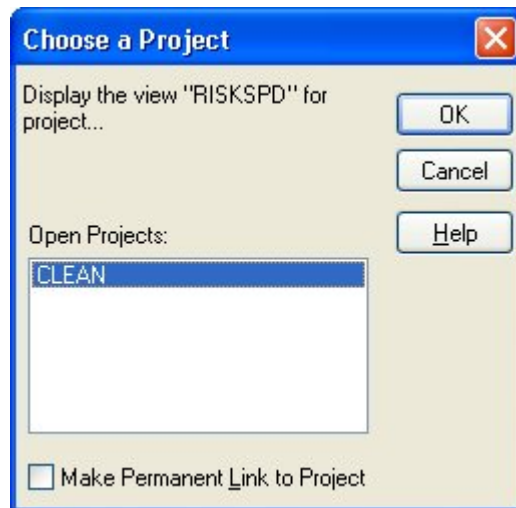

If you double-click a code view to attach to a code file or a resource view to attach to a resource file, the dialog box displayed is titled **Choose a Code File** or **Choose a Resource Pool** respectively and the appropriate open files are displayed. The functionality of the dialog boxes remains the same.

This dialog box allows you to do two things:

- You can create a temporary view without creating a permanent link to the project. This allows you, for example, to sample the various views available in the Open Plan Library without filling the project's Views folder with view links that you do not need.
- You can create a permanent link to the project for a view. Selecting the **Make a Permanent Link to Project** setting instructs Open Plan to create a link to the view for the selected project. The linked is placed in the selected project's Views folder when you click **OK**



Open Plan remembers your selection for the next time you display the **Choose a Project** dialog box. In other words, if you select the **Make a Permanent Link to Project** setting, the next time you display the **Choose a Project** dialog box, this setting will automatically be selected.

If you make changes to a view, you can use the **Save View** command on the **File** menu to display the **Save Current View As** dialog box:

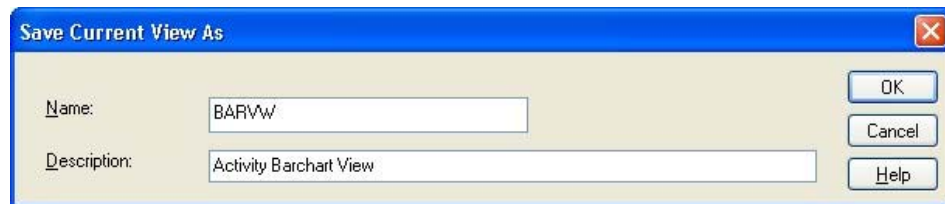

You can use this dialog box to give the view a new name and description.

Open Plan also asks if you want to save your changes when you exit the view.

If you indicate that you want to save your changes, Open Plan displays a dialog box and allows you to perform the following actions:

- To update the original view with your changes, save the view under its current name.
- To create a new view and leave the original one unmodified, save the view with a new name. Open Plan automatically adds this new view to the Open Plan Library and creates a link to it in the project folder.

To assign a view to a project

1. Take one of the following actions:
 - Drag the view from the Open Plan Library to the project folder.
 - Double-click the view in the Open Plan Library , and use the Choose a Project dialog box to select an open project.

To open a view

1. Locate the view in the appropriate project folder.
2. Take one of the following actions:
 - Double-click the view.
 - Right-click the view, and click **Open** on the context menu.
 - Click **View Toolbar** and select from the list. (This allows you to change views while in a project without returning to Explorer.)



You can display a view without first having to open the project. When you display the view, the project is automatically open in default mode.

To save a view

1. Open the view you want to save.
2. Make any required changes to the view.
3. On the **File** menu, click **Save View**.
4. On the **Save Current View As** dialog box, enter the name and description for the view.
5. Click **OK**.

To remove a view from a project

1. From the project Views folder, select the view.
2. Take one of the following actions:
 - Press the **Delete** key.
 - Right-click the view, and click **Delete** on the context menu.
3. When Open Plan asks you to confirm the deletion, click **Yes**.



Deleting the view from the project folder merely removes the link to the view in the Open Plan Library. The view is not removed from the database.

To remove a view from the database

1. From the Open Plan Library, select the view.
2. Take one of the following actions:
 - Press the **Delete** key.
 - Right-click the view, and click **Delete** on the context menu.
3. When Open Plan asks you to confirm the deletion, click **Yes**.



Deleting the view from the Open Plan Library removes the view from the database and any links to it in the project folders.

Browser Views

A browser view allows a Windows shortcut, Internet shortcut, or Open Plan Add-In to be stored as a view in the Views folder of the Open Plan Library. The browser view can then be accessed directly from this folder. It can also be assigned to a project, resource, or code so that it is opened in a particular context.



Once created, a browser view can be used the same as any other view.

Clicking **Browser Views** on the **Tools** menu displays the **Browser Views** dialog box populated with all previously defined browser views: You can create, copy, edit, and delete browser views from this dialog box.

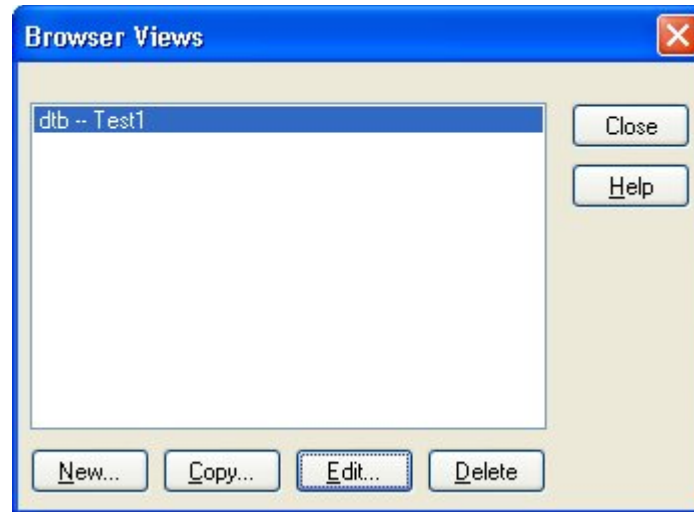

If you click the **New** button, the **New Browser View** dialog displays:

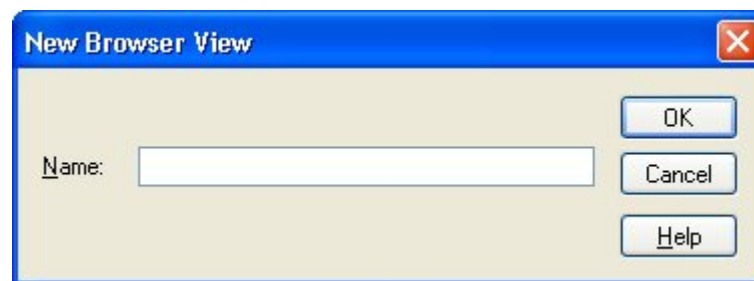

In the **Name** field, enter a name for the new browser view and click **OK**. Open Plan displays the **Browser View Definition** dialog box that you can use you to define the elements of the view:

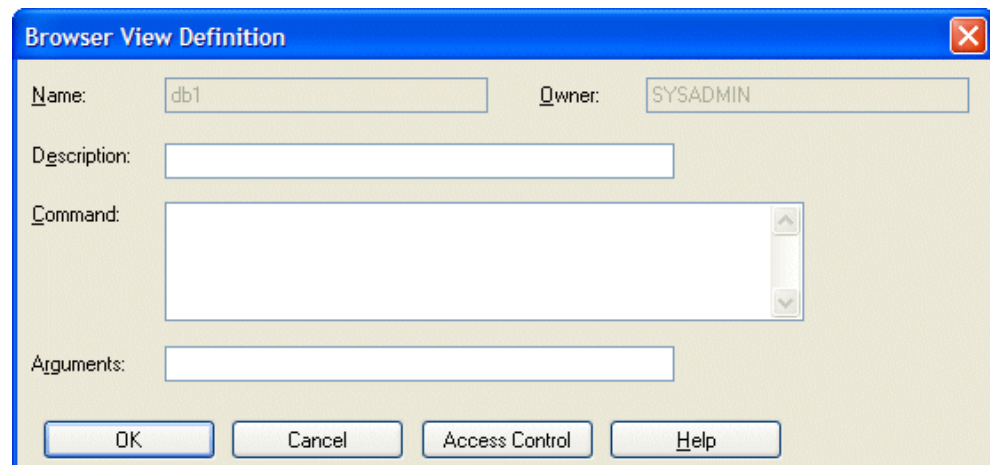

The following fields are displayed on this dialog box:

- **Name** — Displays the name of the browser view and cannot be edited unless you are copying a browser view, in which case the default name displayed is **Copy_<name>**, where **<name>** is the name of the existing browser view.



While you cannot use this dialog box to change the name of an existing browser view, you can change the name in the Open Plan Explorer. Right-click the browser view in the Open Plan Explorer that you wish to change, and click Rename on the context menu.

- **Owner** — Displays the name of the user who created the browser view. This field is required and cannot be edited in this dialog box.



If you are the owner of a browser view or you have system administrator access, you can use the Access Control tab of the view's Properties dialog box to change the owner.

- **Description** — Displays the description of the browser view. This field is optional and can be edited at any time.
- **Command** — Displays the command line to be executed when the browser view is run. For example, the command line could be the path to an executable file or a WebWindow. It can also be a URL to a specific Webpage.

You can enter a fully realized command line or you can make the command relative to either the **Open Plan System** folder or **User** folder. To make the command relative to the **System** folder, you would preface the command with **<SYSDIR>**. To make the command relative to the **User** folder, you would preface the command with **<USERDIR>**.

Example: Assume you want to make the Add-In command **Trace Logic** into a browser view. You could enter the command in one of the following ways:

- C:\Program Files\Deltek\Open Plan Professional\Sample Tools\vbapps\trace\trace.exe
- <SYSDIR>Sample Tools\vbapps\trace\trace.exe



Looking at the **Trace Logic** command in the addins.dat file, you will notice that there are two arguments added to the end of the command line: %P and %A. These command-line arguments are entered in the **Arguments** field.

If you wanted to create a browser view to your company Web site, you would enter a fully realized URL address for the command. For example,

<http://deltek.com/>



To make the Web site open in an internal Open Plan window, add %i in the **Arguments** field.

- **Arguments** — You can specify any number of the following parameters to be passed automatically to the application on the command line. Open Plan supplies these parameters on the command line when launching the browser view.

Parameter	Description
%P	The currently selected project (View or Open Plan Explorer)

Parameter	Description
%S	The currently selected project in Open Plan Explorer
%A	The currently selected Activity ID
%R	The currently selected Resource file (View or Open Plan Explorer)
%r	The currently selected resource
%b	The currently selected code
%B#	Passes the name of the code file in position # in the active open project
%C	The currently selected calendar name (View or Open Plan Explorer)
%c	The currently selected calendar
%M	Allow multiple concurrent instances of the selected tool
%U	The currently logged in user's ID
%W	The encrypted password for the current user
%V	The current view
%E	Launch the file/link in an external Internet browser window
%I	<p>Allows Internet browser to open within an Open Plan window. If the %I is specified, Open Plan formats the other parameters as a URL query string (for example, %P and %A will be passed as ?P=ProjectName&A=ActivityId)</p> <p>Note: If data specific parameters are used, Open Plan will reload the page that was initially loaded in the internal window with an updated query string each time the selected value (project, activity ID, resource, etc.) changes.</p>
%T	When %I is used, tiles the internal browser window
%D	Launches the file/link in a dockable internal browser

Parameter	Description
%X	Maximizes an internal browser window

 If the %I, %D, or %E argument is specified, Open Plan attempts to execute the command line using a browser object or application, respectively. In this situation, you may specify a data file to be launched (in conjunction with an application) or a URL. If the executable must be specified in the command line, omit the %I (for example, Wordpad.exe MyNotes.txt). In this case, the executable is launched within its own (external) window. If the document type is associated on your computer with an application, an internal browser view may be created using the syntax <Document_Name> %I (for example, MyNotes.txt). Remember, if you use either the %I or %E parameters, you need to specify the document to be launched, rather than the application that will launch it. In addition, if a Visual Basic application is launched, you should not use any of the Internet-specific parameters because Open Plan will "canonicalize" the command-line (that is, question marks will be inserted before the arguments). Since VB applications do not understand "canonicalized" arguments, they will fail.

Windows-type shortcuts must be brought up externally if the command line references an application. The shortcuts may be brought up internally if they reference a document whose associated launch application is known to the system.

Internet links may be brought up as either internal (the Internet browser is contained within an Open Plan window) or external (the browser itself is launched as a separate application) browser views.

 The custom WebWindows that are shipped with Open Plan as part of the **Add-Ins** menu can easily be added as browser views. Refer to "The Addins.dat File" section of Chapter 4, "The Open Plan Configuration Files," in the *Deltek Open Plan Developer's Guide* for command line and argument parameter information for each WebWindow.

- **Access Control** — Select this option to grant rights to other users in the data source to use the definition.

 For more information on available WebWindows, refer to Chapter 4, "The Open Plan Configuration Files," in the *Deltek Open Plan Developer's Guide*.

Custom Symbols

You can include custom symbols in many Open Plan Views. For example, you can use a custom symbol for the left and right end of a bar type in a barchart view, or you can include a custom logo in the title block of a printed report.

The **Manage Symbols** dialog box allows you to add, edit, and delete Open Plan custom symbols.

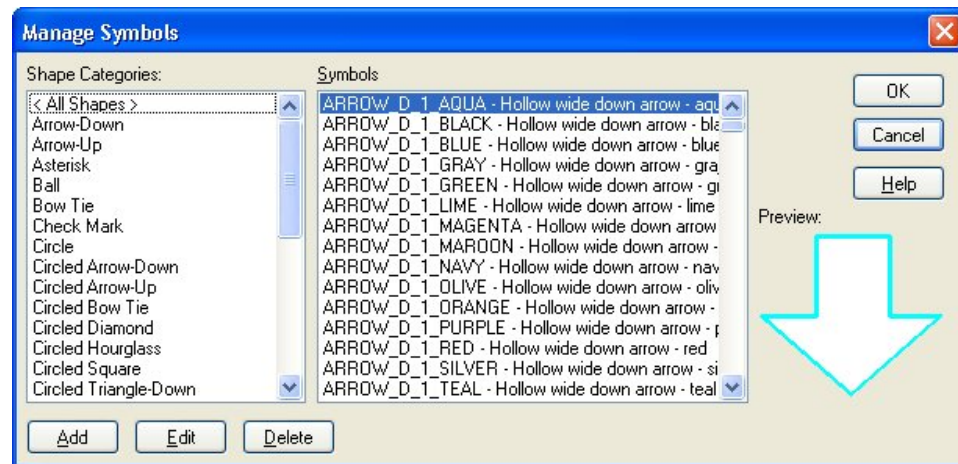

This dialog box has the following controls:

- **Shape** — This pane of the dialog box contains a list of currently defined shape categories. The categories are an easy way to organize the numerous symbols included with Open Plan as well as custom symbols you might add. Selecting a category displays the symbols included in that category in the **Symbols** pane. Two special categories are also included:
 - **<All Shapes>** — Selecting this category displays all the symbols in all the shape categories.
 - **<Uncategorized Shapes>** — Selecting this category displays those shapes that have not been assigned to a category. The **<Uncategorized Shapes>** category does not appear if there are no uncategorized shapes in the system.
- **Symbols** — This pane of the dialog box contains a list of the symbols that are currently available in the selected category. When you select a symbol in this list, it is displayed as a preview on the right side of the dialog box.
- **Add** — Clicking this button displays the **Add Symbol** dialog box that you can use to locate and select a file to use as a custom symbol. Open Plan allows you to use both Meta Files (.wmf) and Enhanced Meta Files (.emf) graphics.
- **Edit** — Selecting a symbol from the list and clicking this button displays the **Edit Symbol** dialog box that you can use to edit the description and shape category of the symbol.
- **Delete** — Selecting a symbol from the list and clicking this button instructs Open Plan to delete the symbol. Before actually performing the action, however, Open Plan asks that you confirm the deletion. If you delete the last symbol in a category, the category is removed from the list of categories.

To display the **Manage Symbols** dialog box use one of the following methods:

Method 1

1. On the **Tools** menu, click **Options**.
2. On the **General** tab of the **Options** dialog box, click **Symbols**.

Method 2

1. On the **Tools** menu, click **Title Blocks**.
2. On the **Title Blocks** dialog box, click either **New** or **Edit** to display the **Title Block Definition** dialog box.
3. On the **Title Block Definition** dialog box, click the **ellipsis** under the **Logo** preview.

Method 3

1. On the **Tools** menu, click **Bar Sets**.
2. On the **Bar Sets** dialog box, click either **New**, **Copy**, or **Edit** to display the **Bar Set Preferences** dialog box.
3. Click **Bar Types**.
4. From the grid on the **Bar Types** dialog box, select a cell in either the **Left** or **Right** column.
5. Click the **ellipsis** next to the entry field at the top of the dialog box.

Using the Add Symbol Dialog Box

The **Add Symbol** dialog box allows you to locate custom symbols and add them to Open Plan for use in numerous views:

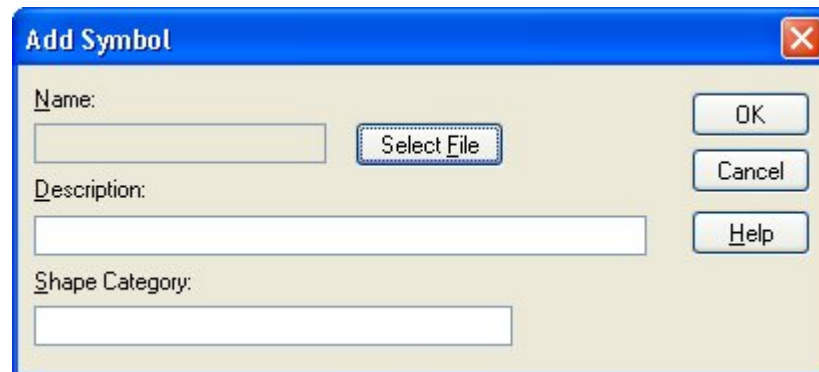

This dialog box contains the following controls:

- **Name** — The filename for the custom symbol you wish to add.
- **Select File** — Clicking this button displays an **Open** dialog box that you use to locate the Meta File (.wmf) or Enhanced Meta File (.emf) graphic file for the symbol. Selecting the file and then clicking **Open** places the filename in the **Name** field.

- **Description** — Additional information you wish to include about the symbol. The description appears next to the symbol name in the **Symbols** pane of the **Manage Symbols** dialog box.
- **Shape Category** — You can create a new shape category by entering a unique name in this field. Otherwise, entering an existing category name places the new symbol in that category.

To add a custom symbol

1. On the **Manage Symbols** dialog box, click **Add**.
2. On the **Add Symbol** dialog box, click **Select File**.
3. Using the **Open** dialog box, navigate to the desired .wmf or .emf file, and select it.
4. Click **Open**.
5. Enter a description for the new symbol. (This step is optional.)
6. Enter a shape category for the new symbol.
Leaving this field blank will place the new symbol in the **<Uncategorized Shapes>** category.
7. To return to the **Manage Symbols** dialog box, click **OK**.

Using the Edit Symbol Dialog Box

The **Edit Symbol** dialog box allows you to edit the description and shape category of a selected symbol:

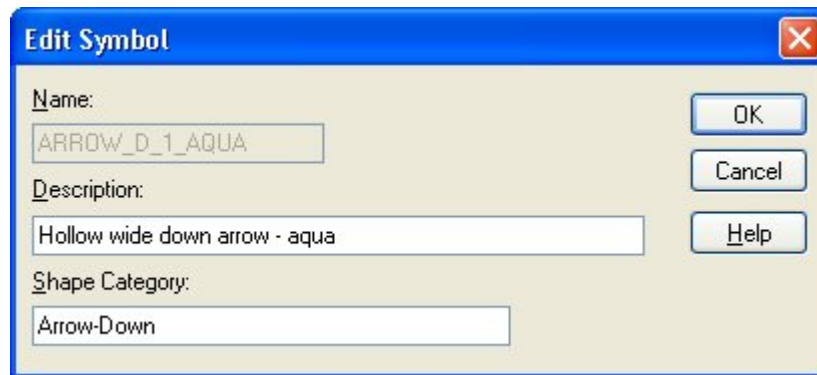

To edit an existing symbol

1. From the **Manage Files** dialog box, select the symbol to edit.
2. Click **Edit**.
3. On the **Edit Symbol** dialog box, enter a new description and shape category.
4. When finished, click **OK**.

Printing Reports

You can output any Open Plan view or data file display to external devices such as a printer or a plotter to produce a report. Open Plan functions related to the creation of reports include:

- The **Print** command
- The **Print Setup** command
- General print options
- Print options for barcharts and histograms
- The definition of title blocks
- The **Print Preview** command

Each of these functions is described in the following sections.



You should have a default printer selected in Windows before using any of the above options. For information about setting up a default printer in Windows, refer to either the Windows documentation or the documentation supplied with the printer.

Using the Print Command

The operation of the **Print** command differs slightly depending on the type of report you are producing.

When you select the **Print** command from barchart views, network views, spreadsheet views, histogram views, resource displays, or code displays, Open Plan displays the following dialog box:

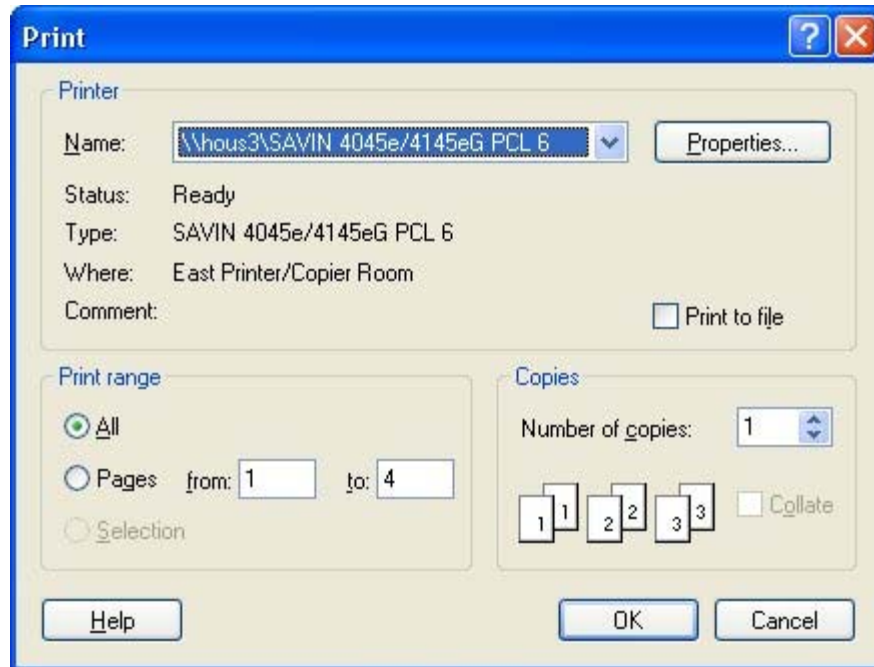

Using this dialog box, you can enter the following settings about the print operation:

- **Printer** — You can select a default printer as well as a specific printer for a report.



To set advanced options for your output device, click **Properties**. The options that can be set using this dialog box depend on the device type.

- **Print Range** — You can print all the pages of the view or define a range of pages to print.



The **Selection** option is not supported in Open Plan.

- **Copies** — You can specify how many copies of the report to be print.
- **Collate** — Depending on the capabilities of your output device, you can indicate if multiple copies of the report should be collated.

When you select the **Print** command from a calendar display, Open Plan displays slightly different versions of the **Print** dialog box that allow you to define the range of data to print by entering a time span.

To produce a report

1. Take one of the following actions:
 - Press **Ctrl+P**.
 - On the **File** menu, click **Print**.
 - On the toolbar, click the **Print** button.
2. Enter the information for the report.
3. When the information is correct, click **OK**.



Print button

Using the Print Setup Command

You can use the **Print Setup** command to select a printer and related information. When you click **Print Setup** on the **File** menu, Open Plan responds by displaying the following dialog box:

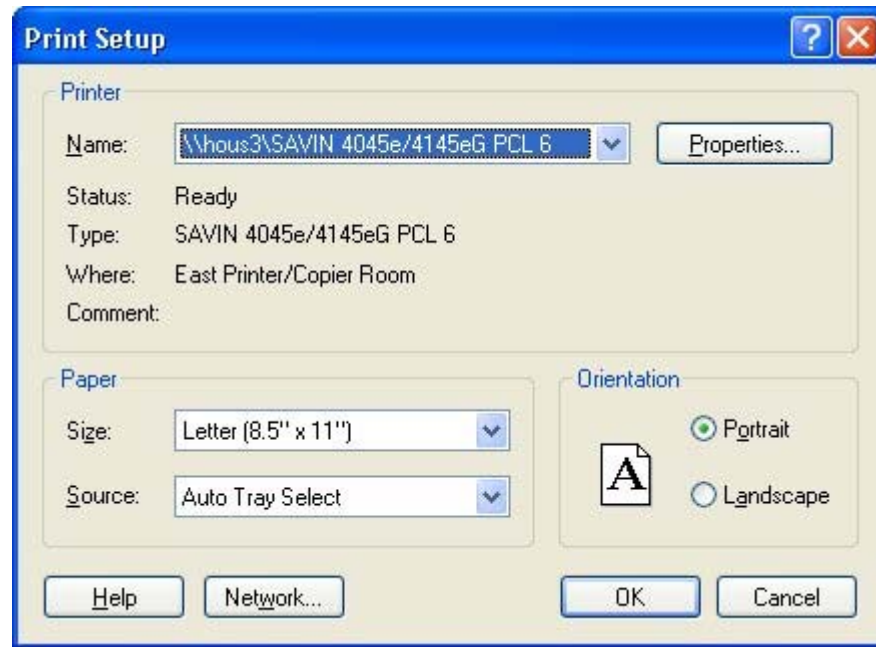

You can use this dialog box to enter the following information:

- **Printer** — You can select a default printer as well as a specific printer for a report.



To set advanced options for your output device, click **Properties**. The options that can be set using this dialog box depend on the device type.

- **Paper** — You can specify a size and tray source for paper.
- **Orientation** — You can specify either portrait (vertical) or landscape (horizontal) orientation for a report. This setting is saved with each view.



If you change the **Orientation** option in the **Print Setup** dialog box, Open Plan automatically changes the **Orientation** option in the **Print Options** dialog box as well.

- **Network** — Clicking this button allows you to connect to a shared network printer.

To use the Print Setup command

1. On the **File** menu, click **Print Setup**.
2. Enter the information for the printer, page size, and orientation.
3. When the information is correct, click **OK**.

General Print Options

The **Print Options** command allows you to define a number of parameters that affect the general appearance for reports based on any type of view or display other than a calendar display. If you select this command, Open Plan displays the following tabbed dialog box:

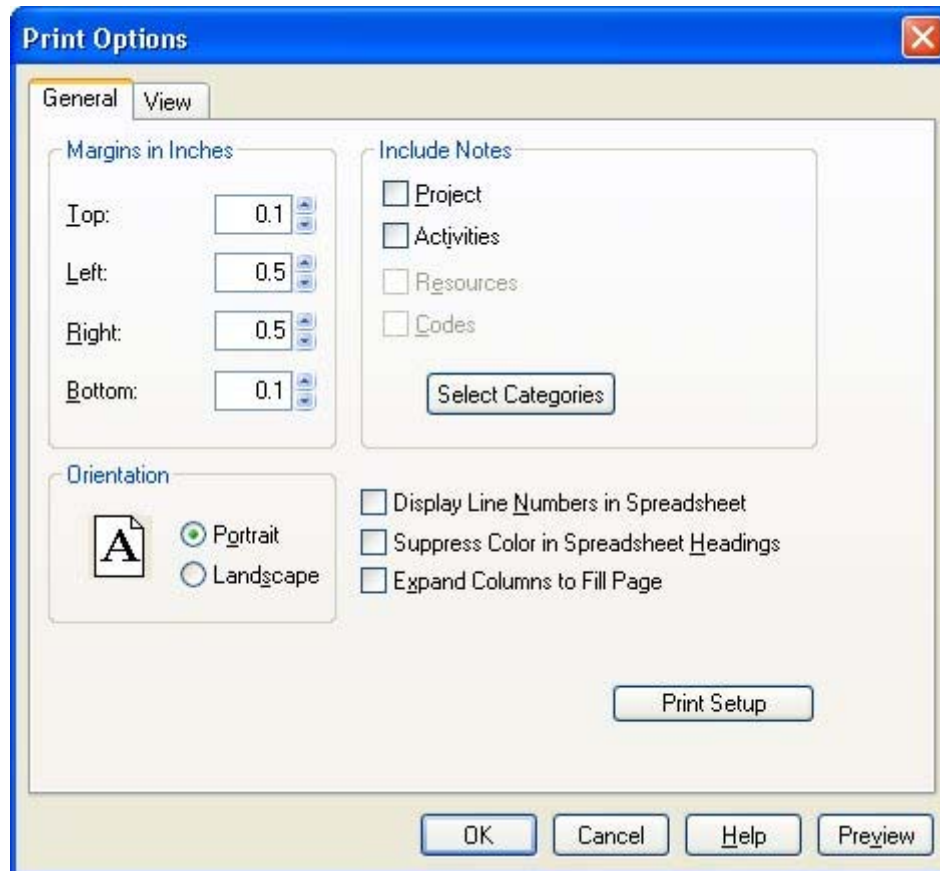

You can use the **General** tab of this dialog box to enter the following settings:

- **Margins in Inches** — Open Plan allows you to enter the top, left, right, and bottom margins in 1/100ths of an inch. These values are added to any margins defined for the output device driver and are saved with the view.
- **Orientation** — You can specify either portrait (vertical) or landscape (horizontal) orientation for a report. This setting is saved with each view.



Changing the **Orientation** option in the **Print Options** dialog box has no effect on the setting of the **Orientation** option in the **Print Setup** dialog box.

- **Include Notes** — You can specify the type (project, activities, resources, or codes) and category for notes included in the report.



For more information about notes, refer to the “Notes” section in this chapter.

- **Select Categories** — Clicking this button displays the **Select Note Categories** dialog box that contains a list of all defined note categories in the data source. Simply select the note category you want, and click **OK**.

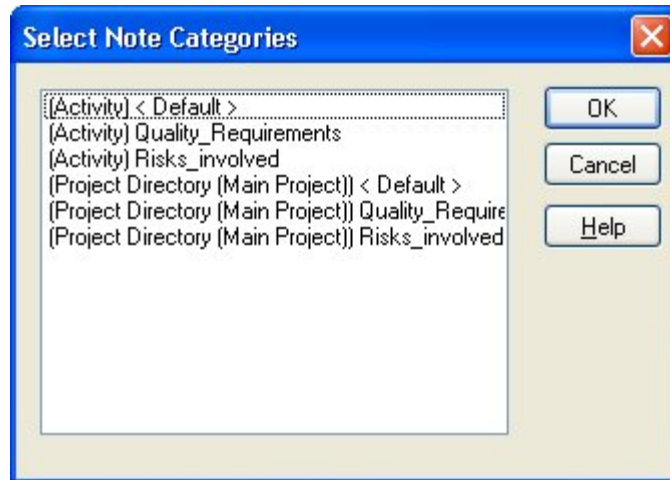

You can select multiple categories from the list in the **Select Note Categories** dialog box.

- **Display Line Numbers in Spreadsheet** — If you are printing a spreadsheet report (or the spreadsheet portion of a barchart report), you can have Open Plan number the rows of the report.
- **Suppress Color in Spreadsheet Headings** — Selecting this option instructs Open Plan to suppress the use of color in spreadsheet column headings and to print column headings with black text on a white background.
- **Expand Columns to Fill Page** — This option applies to barchart views. Selecting this option instructs Open Plan to stretch columns in a spreadsheet to eliminate white space between the spreadsheet and barchart panes of the view.

To set general print options

1. On the **File** menu, click **Print Options**.
2. Enter the information for the report. To see a preview of the printed report, click **Preview**.
3. When the information is correct, click **OK** to return to the view.

Print Options for Barcharts and Histograms

If you are displaying a time-scaled view such as barchart or histogram at the time you use the **Print Options** command, the **Print Options** dialog box includes a **View** tab:

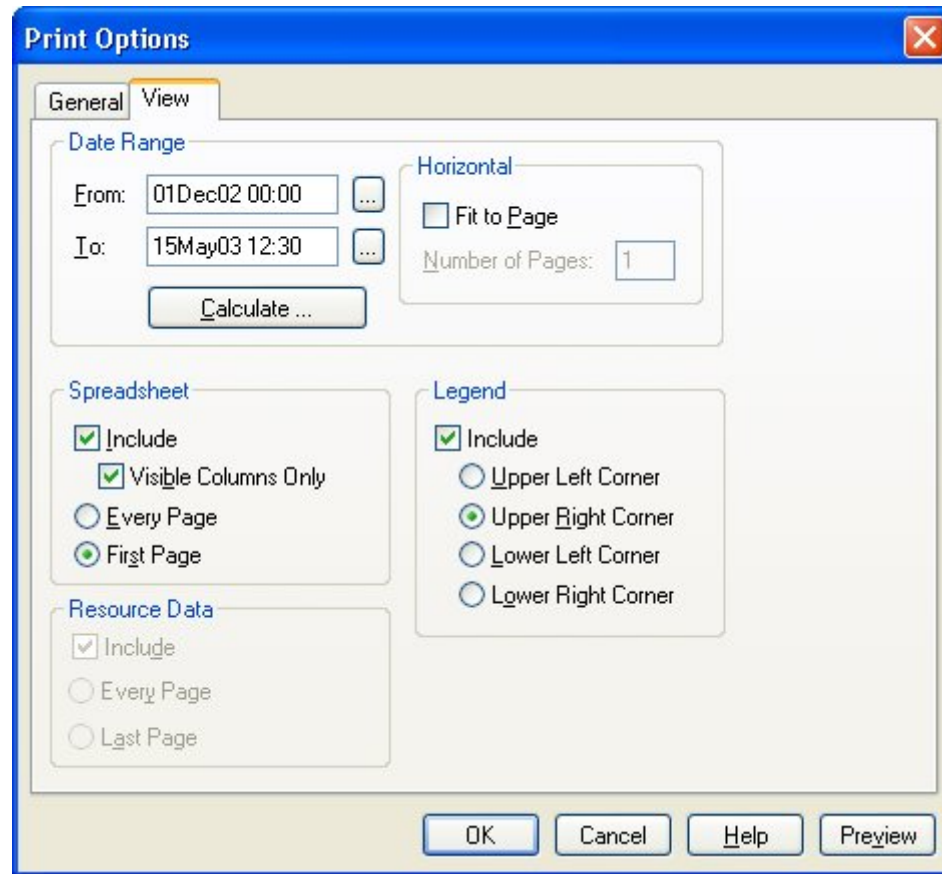

Use the **View** tab to enter the following settings.

- **Date Range** — You can enter a specific range of dates for the report, or you can have Open Plan calculate the range of dates for you using the **Calculate** button.
- **Calculate** — Clicking this button displays the **Date Range Options** dialog box that you can use to specify how Open Plan should calculate the range of dates for the report.



For more information, refer to the “Using the Date Range Options Dialog Box” section later in this chapter.

- **Horizontal** — This option controls whether Open Plan should adjust the horizontal scaling of the report to fit to a specified number of pages.
- **Spreadsheet** — If you are printing a barchart report, you can indicate whether Open Plan should include the spreadsheet portion of the view when producing the report. You have the option of printing all columns or just those columns visible on the screen. For multi-page barchart reports, you can also indicate whether the spreadsheet columns should appear on all pages or on the first page of the report only.
- **Resource Data** — For barchart reports, you can indicate whether Open Plan should include the histogram pane of the view when producing the report. For multi-page barchart reports, you can also indicate whether the histogram should appear on all pages or only on the last page of the report.

- **Legend** — For barchart reports, you can include a legend for the different bars. This legend can appear on each page of the report in one of the following locations:
 - Upper left corner
 - Upper right corner
 - Lower left corner
 - Lower right corner



You must have the appropriate title block enabled to display a legend in a report. For information about title blocks, refer to the “Defining Title Blocks” section in this chapter.

To set view print options

1. On the **File** menu, click **Print Options**.
2. Click the **View** tab.
3. Enter the information for the report, and click **OK** to return to the view.

Using the Date Range Options Dialog Box

The **Date Range Options** dialog box allows you to specify how Open Plan should calculate the date range that is displayed in a printed barchart, resource histogram, and risk histogram view. Clicking **Calculate** on the **View** tab of the **Print Options** dialog box displays the following:

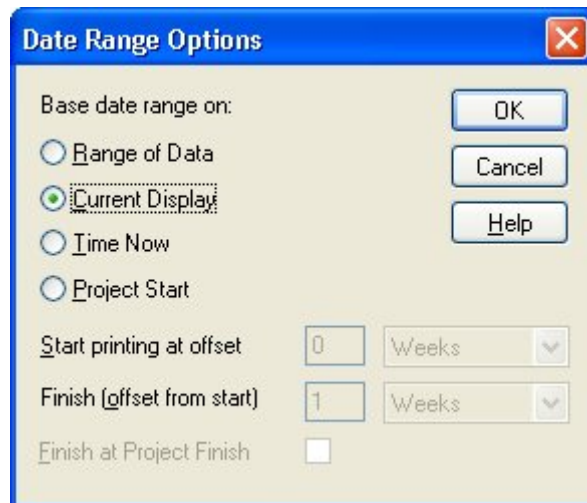

You can instruct Open Plan to base the date range on any of the following:

- **Range of Data** — Bases the date range on the range of data in the barchart, resource histogram, or risk histogram view. The data that is included in the printed report can include a larger date range than that currently displayed in the view.
- **Current Display** — Bases the date range on what is currently displayed in the barchart, resource histogram, or risk histogram view. If you resize the window in which the view is displayed, Open Plan recalculates the date range to print only the data that is actually displayed.

- **Time Now** —Bases the date range on your settings relative to Time Now.
- **Project Start** — Bases the date range on your settings relative to the date the project started.

Also, if you choose to base the date range on either Time Now or the project start date, Open Plan enables the following additional options:

- **Start printing at offset** — Using these fields, you can specify the starting date on the printed report as a specified number of hours, days, weeks, months, quarters, or years before or after the Time Now date. (Entering a negative number in this field tells Open Plan to start the report before the Time Now date, while entering a positive number tells Open Plan to start the report after that date.)
- **Finish (offset from start)** — Using these fields, you can specify the last date on the printed report as a specified number of hours, days, weeks, months, quarters, or years after the start date of the printed report.
- **Finish at Project Finish** — If you select this option, Open Plan uses the last date in the project as the last date in the printed report.

To display the Date Range Options dialog box

1. On the **File** menu, click **Print Options**.
2. Click the **View** tab.
3. On the **View** tab, click **Calculate**.

Defining Title Blocks

A title block can display information about the project such as the project name, Time Now, or the project start and finish date as well as a legend of the different bars for barchart reports:

Project:	CLEAN	Dettek Dettek Client Environmental Cleanup Project			Planned	
Time Now:	01Jan03				Critical	
Start:	01Jan03				Late Dates	
Finish:	15Mar05				Milestone	
Run:	03Jul08				Progress	
					Summary	
					Float	

Activity ID	Activity Desc.	Duration	Total Float	Early Start	Dec				Jan			
					07	14	21	28	04	11	18	25
1	Environmental Management System	572d	0	02Jan03								
1.01	Requirements Development	54d	4d	02Jan03								
1.01.01	Requirements Coordination & Planning	30d	4d	05Feb03								
1.01.02	Site Management	24d	4d	02Jan03								
1.02	Coordination Planning	29d	4d	19Mar03								
1.02.01	Engineering Field Testing	13d	4d	19Mar03								
1.02.02	System Integration	16d	4d	07Apr03								
1.03	Environmental Package System	131d	4d	29Apr03								
1.03.01	Chemical & Mineralogical Survey	3d	4d	29Apr03								
1.03.02	Geochemical Properties	50d	4d	02May03								
1.03.03	Spent Fuel Modeling	50d	44d	02May03								
1.03.04	Spent Fuel Tests	38d	44d	11Jul03								
1.03.05	Research Integration Model	10d	4d	11Jul03								
1.03.06	Thermodynamic Data Research	22d	4d	25Jul03								
1.03.07	Design, Fabrication Prototype	46d	4d	26Aug03								
1.04	Environmental Package Design Specifications	92d	4d	29Oct03								
1.04.01	Environmental Package Design Construction	60d	4d	29Oct03								
1.04.02	Container Fabrication Development	32d	4d	23Jan04								
1.05	Site Investigations	50d	4d	09Mar04								
1.05.01	Site Investigation Integration	2d	4d	09Mar04								
1.05.02	Surface Test Coordination	8d	4d	11Mar04								

To define a title block for a report, click **Title Blocks** on the **Tools** menu to display the following dialog box:

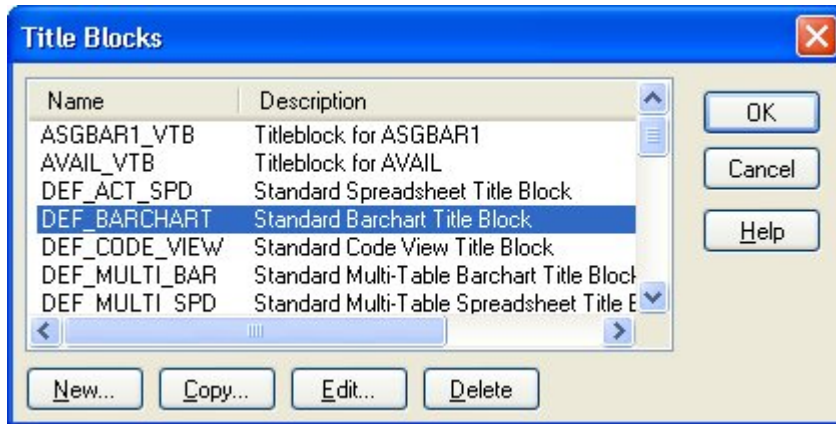

From this dialog box, you can create, copy, edit, or delete a title block. Clicking **New**, **Copy**, or **Edit** displays the following dialog box:

 If you edit an existing title block, you cannot change its name.

The **Title Block Definition** dialog box allows you to define the contents for as many as six different title blocks for the report:

- Top left
- Top center
- Top right
- Bottom left
- Bottom center
- Bottom right

You can specify the percentage of the header or footer that a title block can occupy by defining the location of divider lines marking the left or right title blocks. For example, by setting the divider lines for both left and right title blocks to 25%, you can define a header in which the central title block occupies 50% of the available space, or you can have Open Plan calculate the required width by using **-1**.

The contents of each defined title block can contain up to 5 lines of text defined and formatted by the user. Open Plan automatically aligns text appearing in title blocks as follows:

- Text appearing in a top left or bottom left title block is left-aligned in relation to the left page margin.

- Text appearing in a top center or bottom center title block is centered.
- Text appearing in a top right or bottom right title block is left-aligned in relation to the divider line.

Each line can include literal text as well as text fields stored by Open Plan. To see the available text fields, click **Fields** to display the following dialog box:

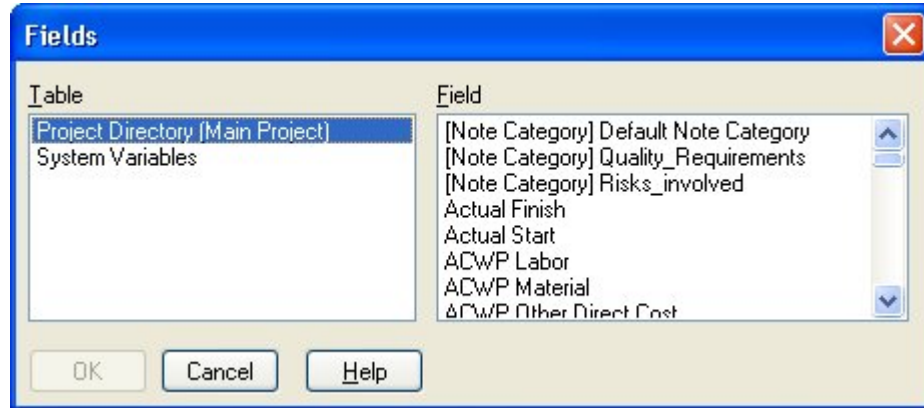

Text fields include the following types of information:

- The project name, description, and manager
- The project start and finish dates
- The name and description of the current project baseline
- The names of the project calendar and resource files
- The client or company name (entered on the **Summary** tab of the **Project Properties** dialog box)
- The current page number of the report
- The total number of pages in the report
- Time Now
- The system date and time
- The filter or sort that is currently in effect
- The view description (entered using the **Properties** dialog box)

You can combine variable text items with literal text to define title blocks such as:

- Report Created for <Client>
- Time Now: <Time Now>
- Page <Current Page> of <Total Pages>

A title block can also include a user-defined logo. To specify the logo for a title block, select **Include** and use the **ellipsis** button to display the **Manage Symbols** dialog box that you use to select the logo.



For more information on using the **Manage Symbols** dialog box, refer to the "Custom Symbols" section earlier in this chapter.

The **Access Control** option is used to grant rights to other users in the data source to use the definition.

The **References** option displays the References dialog box, which has a list of items that use the title block. This list of items includes the file type, name of the project or file, description, and owner.

To define a title block for a report

1. On the **Tools** menu, click **Title Blocks**.
2. On the **Title Blocks** dialog box, take on of the following actions:
 - To create a new title block, click **New**.
 - To copy an existing title block, select the title block, and click **Copy**.
 - To edit an existing title block, select the title block, and click **Edit**.
3. Enter the information for the title block.

To include variable text in the title block, place the insertion cursor in the entry box for a line, and click **Fields**.

To define the boundaries for a left or right title block in the header or footer, enter a value for the **Divider Line** setting.



This setting is not available for center title blocks.

To insert a graphic to appear as a logo in a title block, select **Include**, display the **Manage Symbols** dialog box, and select the appropriate graphic file.

4. When the information for the report is correct, click **OK**.
5. To return to the view, select the title block, and click **OK**.

To see a preview of the printed report, click **Print Preview** on the **File** menu, or click the **Print Preview** button on the toolbar.



To insert a right-alignment tab in a left title block or a left-alignment tab in a right title block, use /t.



Print Preview
button

Previewing a Report

The **Print Preview** command allows you to see exactly how a report will be printed based on the current settings in the **Print**, **Print Setup**, **Print Options**, and **Title Blocks** dialog boxes.

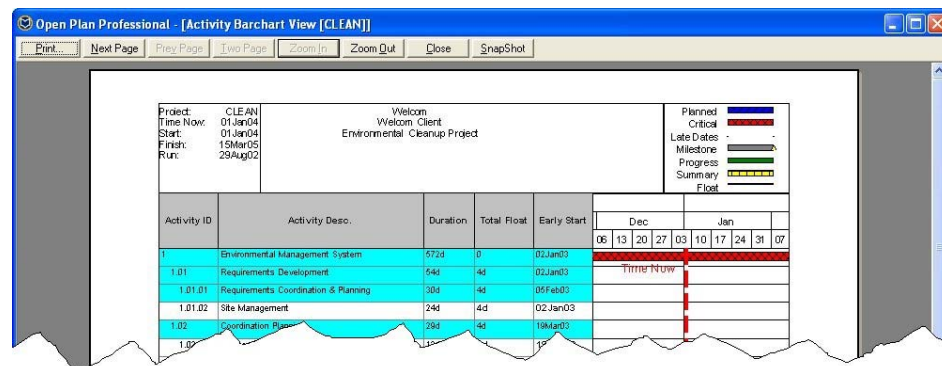



Zoom cursor

The print preview window includes a zoom cursor that allows you to zoom in on any portion of the report you want to examine in greater detail.

Other features available as buttons in the print preview window include:

- **Print** — Prints the report
- **Next Page** — Displays the next page of the report
- **Prev Page** — Displays the previous page of the report
- **One/Two Page** — Toggles the display between showing one page or two pages of the report
- **Zoom In** — Magnifies the display of the indicated area of the report
- **Zoom Out** — Shrinks the display of the report in the window
- **Close** — Closes the print preview window and return to the current view
- **Snapshot** — Creates a .jpg image of the report in a directory you specify

To preview a report

1. Take one of the following actions:

- On the **File** menu, click **Print Preview**.
- On the toolbar, click the **Print Preview** button.

Open Plan displays a print preview window of the current view.

To zoom in on an area of the window, click the desired area with the zoom cursor.

2. To return to the view, click **Close**.

Reporting Calendars

Reporting calendars allow you to view time-scaled data in a barchart or histogram view using a non-linear date scale. Using reporting calendars you can, for example, display a histogram that shows resource usage on a monthly basis for the next three months, on a quarterly basis for the four quarters following that, and on a yearly basis for the remaining years of the project.

Reporting calendars are a useful reporting tool since planners and project managers tend to be more interested in detailed information for events happening relatively soon. For events happening in the more distant future, on the other hand, information summarized to a higher level is often perfectly adequate and may be more understandable.

With the Professional edition of Open Plan, you can define multiple reporting calendars that can be used with any project. This makes it easy to create views and reports that show the same data summarized against different sets of reporting periods. Using this feature you can, for example, set up one view that shows the project cost estimates against your standard fiscal reporting periods and another view that shows the same data using the client's reporting periods.

To see the list of available reporting calendars, click **Reporting Calendars** on the **Tools** menu to display the following dialog box:

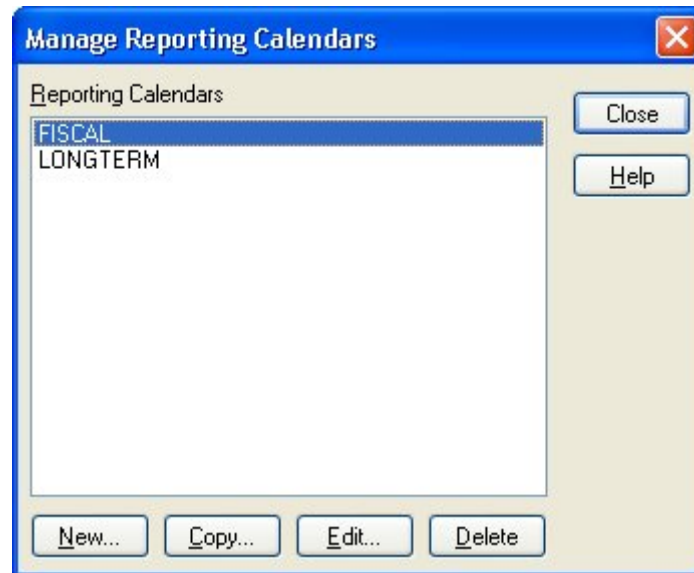

To define a reporting calendar, you can enter a set of cut-off dates and labels using the following dialog box:

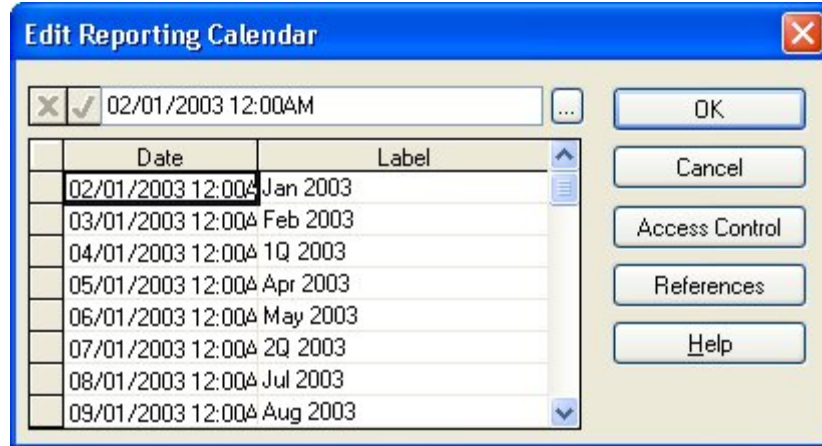

Notice in this example how labels are used to indicate whether the dates represent the end of a month, a quarter, or a year.

For data prior to the first date, Open Plan uses the first reporting periods to extrapolate the period interval in order to report the data. For data after the last date, Open Plan extrapolates the period interval using the last two reporting periods. For example, assume you have defined the reporting calendar to report data in weeks for 4 weeks and then in months for 11 months. For data prior to the first date in the reporting calendar, Open Plan will use the first two reporting periods to determine the period interval is weeks and report the data accordingly. Data following the last date in the reporting calendar is displayed in months.



For information about using a reporting calendar in a barchart or histogram date scale, refer to Chapter 18, "Barchart Views."

To create a reporting calendar

1. On the **Tools** menu, click **Reporting Calendars**.
2. On the **Manage Reporting Calendars** dialog box, click **New**.
3. In the **Add Reporting Calendar** dialog box, enter a name for the reporting calendar, and click **OK**.
4. In the **Edit Reporting Calendar** dialog box, enter the cut-off dates and the labels for the reporting periods in the calendar.
5. When the information for the reporting calendar is complete, click **OK** to return to the **Reporting Calendars** dialog box.

To edit a reporting calendar

1. On the **Tools** menu, click **Reporting Calendars**.
2. Select the reporting calendar you want to update, and click **Edit**.
3. In the **Edit Reporting Calendar** dialog box, update the dates and labels for the reporting calendar.
4. When the information for the reporting calendar is complete, click **OK** to return to the **Manage Reporting Calendars** dialog box.

To copy a reporting calendar

1. On the **Tools** menu, click **Reporting Calendars**.
2. Select the reporting calendar you want to copy, and click **Copy**.
3. In the **Copy Reporting Calendar** dialog box, enter a new name for the copy, and click **OK** to return to the **Manage Reporting Calendars** dialog box.

To delete a reporting calendar

1. On the **Tools** menu, click **Reporting Calendars**.
2. Select the reporting calendar you want to delete, and click **Delete**.
3. When Open Plan asks you to confirm the deletion, click **Yes**.

Assigning a Reporting Calendar

You can specify a default reporting calendar on the **Cost** tab of the **Project Properties** dialog box:

The screenshot shows the 'Project Properties' dialog box with the 'Cost' tab selected. The 'Project Name' is 'CLEAN' and the 'Description' is 'Environmental Cleanup Project'. The 'Target Total Cost' is 0 and the 'Reporting Calendar' is set to 'FISCAL'. There is a checked option for 'Use Version 2 Cost Calculation Method'. Below this is a table with the following data:

	BAC	BCWS	BCWP	ACWP	EAC
Labor Quantity	7858.00	0.00	0.00	0.00	7858.00
Labor Cost	440321.00	0.00	0.00	0.00	440321.00
Material Cost	148800.00	0.00	0.00	0.00	148800.00
ODC	0.00	0.00	0.00	0.00	0.00
Subcontract Cost	0.00	0.00	0.00	0.00	0.00
Total Cost	589121.00	0.00	0.00	0.00	589121.00

The **Reporting Calendar** field is used as a default reporting calendar for the date scale if the reporting calendar option is chosen. When creating or updating a baseline, Open Plan uses the data in this file to break any usage records that span more than one calendar period into additional records.



While this feature may be used with any Open Plan project, it is particularly useful to Cobra users as it improves the ability of Cobra to display Open Plan baseline information accurately.

Notes

As an aid to reporting, Open Plan allows you to attach notes consisting of text information to the following:

- Projects
- Resource files
- Code files
- Activities
- Individual resources
- Individual codes

These notes can be included in reports based on many of the standard project views.

To attach a note to a project, resource file, or code file, display the appropriate **Properties** dialog box, and click the **Notes** tab. To attach a note to an activity, individual resource, or individual code, display the appropriate **Details** dialog box, and click the **Notes** tab.

The **Notes** tab uses the same format regardless of the dialog box:

You can use the following fields to attach a note to an object:

- **Note** — This text box can contain up to 29 KB of text. You can enter the text by typing directly in this field or by using the Windows **Cut (Ctrl+X)**, **Copy (Ctrl+C)**, and **Paste (Ctrl+V)** commands to insert text from another Windows application such as a word processor or spreadsheet.
- **Category** — This field controls the category of the note. You can select a category from the list of global categories.

Clicking the **abc** button checks the spelling of the text you enter.

You can enter links to files, Web pages, and e-mail addresses by entering the information in one of the following formats:

- File links must be entered in the format of: <file://c:\document.doc>

 If The file link you enter contains spaces, you must enclose the link with angle brackets (< >) in order for the link to work properly:
<file://C:\Documents and Settings\All Users\Desktop\test.txt>

- Universal Resource Locators (URLs) must be entered in the format of: **http://deltek.com**
- E-mail addresses must be entered in the format of: **mailto:sales@deltek.com**

 While you can use drag and drop functionality to create links in the **Note** field, the Windows **Cut (Ctrl+X)**, **Copy (Ctrl+C)**, and **Paste (Ctrl+V)** commands are not available for links.

Once you enter a note for an activity, resource, or code, Open Plan marks the object so that you can see which items have notes attached. In a spreadsheet view, for example, Open Plan adds a note icon to the selection button:

The screenshot shows a Gantt chart view with a list of activities on the left. Activity 1.01.01, 'Requirements Coordination & Planning', has a note icon (a small square with a diagonal line) on its selection button. A blue arrow points to this icon with the text 'Indicates activity has note attached.' The Gantt chart shows bars for various activities across months from December to March.

When displaying a resource or code structure, on the other hand, objects with notes are indicated by the lower right corner of the element box being shaded:

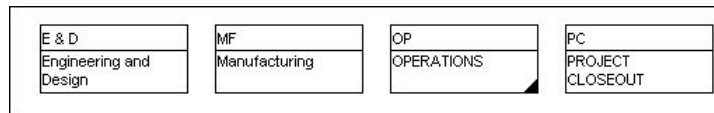

To delete a note attached to an object, simply delete all the text displayed in the **Note** text box.

Using Note Categories

Note categories allow you to group related types of notes for reporting purposes. For example, you might want to set up two categories of notes: one for information related to subcontractors and another for documenting changes in scope that occur over the course of a project. To define new notes categories, you must use the Professional edition of Open Plan.

To define note categories, click **Note Categories** on the **Tools** menu to display the following dialog box:

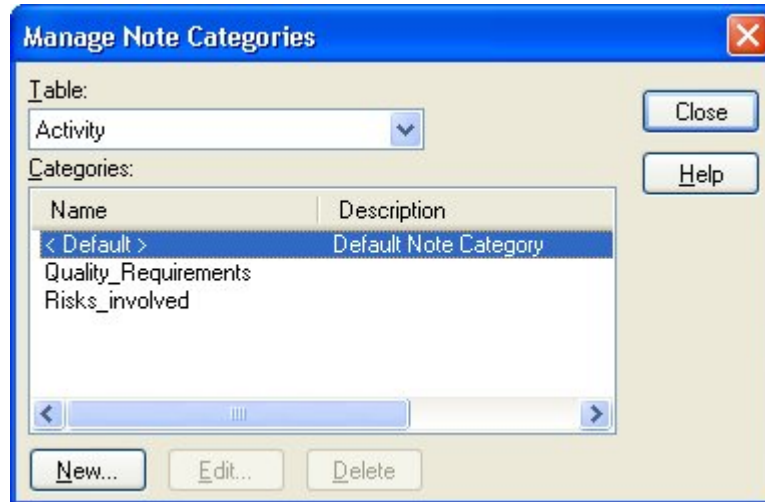

From this dialog box you can add a category, edit the name of an existing category, or delete a category.



If you delete an existing category, Open Plan deletes all the notes assigned to that category.

Once you have set up categories, they are stored in the database and are available to all projects, resource files, and code files. You can assign a particular note to one of the defined categories from the **Category** list displayed above the **Note** text box:

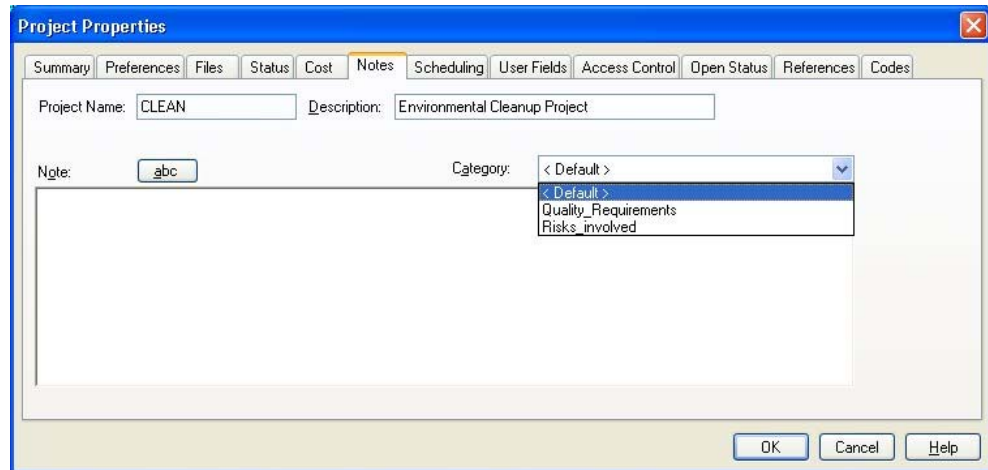

To define a note category

1. On the **Tools** menu, click **Note Categories**.
Open Plan displays the **Manage Note Categories** dialog box.
2. From the **Table** list, select a table for which to create the note category.
3. Click **New**.
4. Enter a name and description for the new note category, and click **OK**.

To edit a note category

1. In the **Tools** menu, click **Note Categories**.
2. In the **Manage Note Categories** dialog box, select the note category to edit.
3. Click **Edit**.
4. Enter a new description, and click **OK**.



You can edit only the **Description** of a note category.

To delete a note category

1. In the **Tools** menu, click **Note Categories**.
2. In the **Manage Note Categories** dialog box, select the note category to delete.
3. Click **Delete**.

Including Notes in Reports

You can produce reports that include notes from any activity view (with the exception of relationship and assignment spreadsheets), resource display, or code display. For activity-based reports, you can include project notes, activity notes, or both.

To include notes in a report, display the **General** tab of the **Print Options** dialog box:

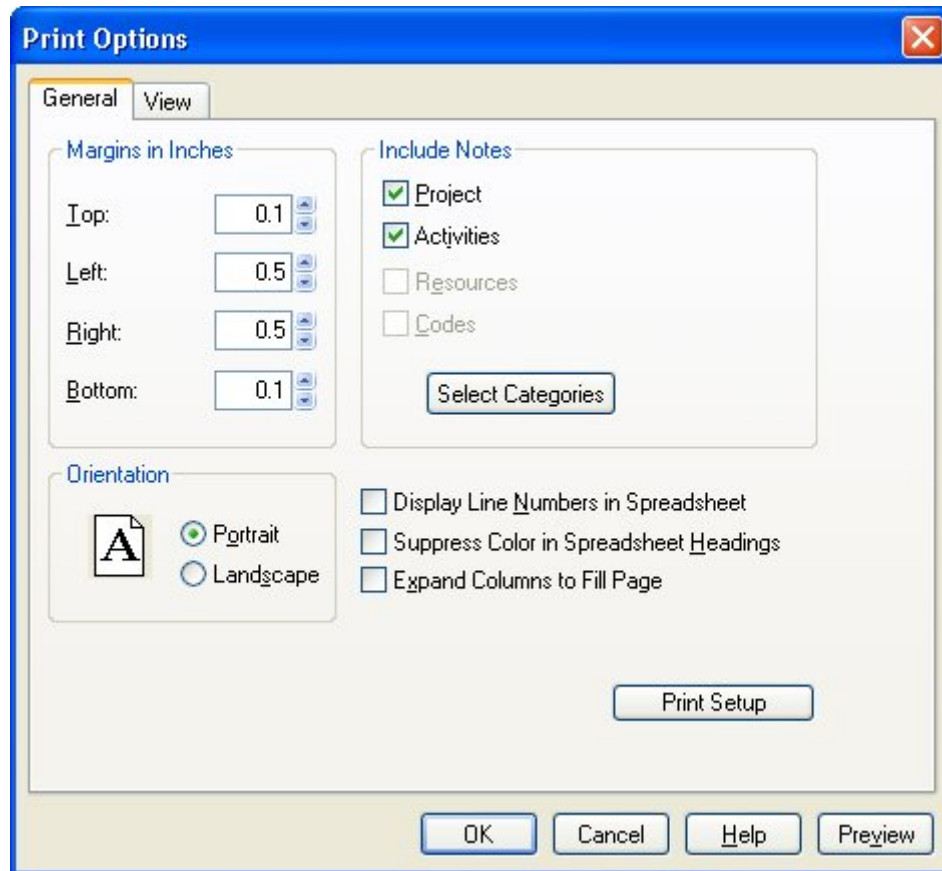

Click **Select Categories** to display the **Select Note Categories** dialog box:

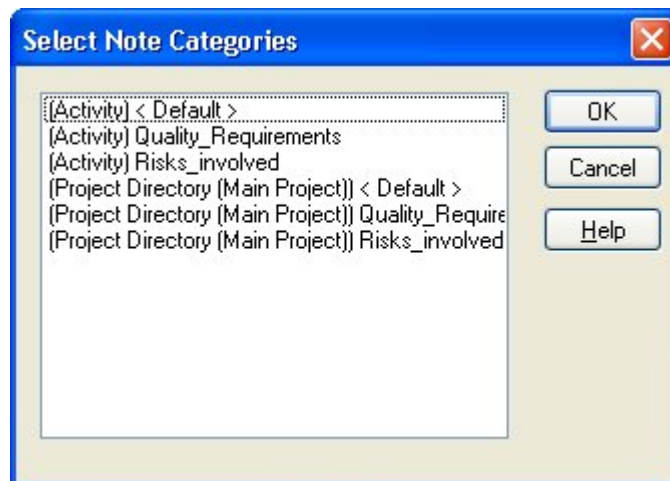

To print all the notes attached to items in the report, select all the categories by either **Shift**+clicking or **Ctrl**+clicking the categories.

When you include notes in a report, Open Plan displays them on one or more separate pages following the main body of the report. Each note is labeled with the category, the author (if known), and the creation date.

18

Barchart Views

➤ Overview	425
➤ Customizing the Date Scale.....	426
➤ Barchart Display Options	435
➤ Multi-Table Barcharts.....	437

Overview

Since they provide an easy-to-understand graphical representation of important project dates, barcharts are widely used by many organizations to communicate information about the project schedule. The interactive barchart views supplied with Open Plan are designed to facilitate the entry and display of scheduling information appropriate for many conventional types of projects. However, Open Plan also includes some powerful customizing features that allow you to prepare barcharts that meet any special requirements your organization might have.

This chapter discusses customizing the bar display portion of a barchart view. You can modify the appearance of the date scale used in the barchart, the barchart legend, and the settings of options for a view.



For information about more extensive customization of a barchart view, including the appearance of bars and the display of time-phased cost data, refer to Chapter 6, "Customizing Barchart Views," in the *Deltek Open Plan Developer's Guide*. For information about the spreadsheet and the resource histogram portions of a barchart view, refer to Chapter 20, "Spreadsheet Views," and Chapter 21, "Histogram Views," in this user's guide.

Customizing the Date Scale

Because reporting standards vary widely between organizations, Open Plan allows you to define the components of the date scale on the barchart view. This date scale controls both the display of bars and the aggregation of resources in the histogram portion of the view. (The histogram bars correspond to the smallest date unit defined for the date scale.)

You can define the settings for the date scale using any of the following methods:

- Using autoscaling.
- Defining the settings manually.
- Creating a date scale based on one or more custom reporting calendars.

To select a method for defining the date scale, display the **Options** tab of the **Date Scale Preferences** dialog box:

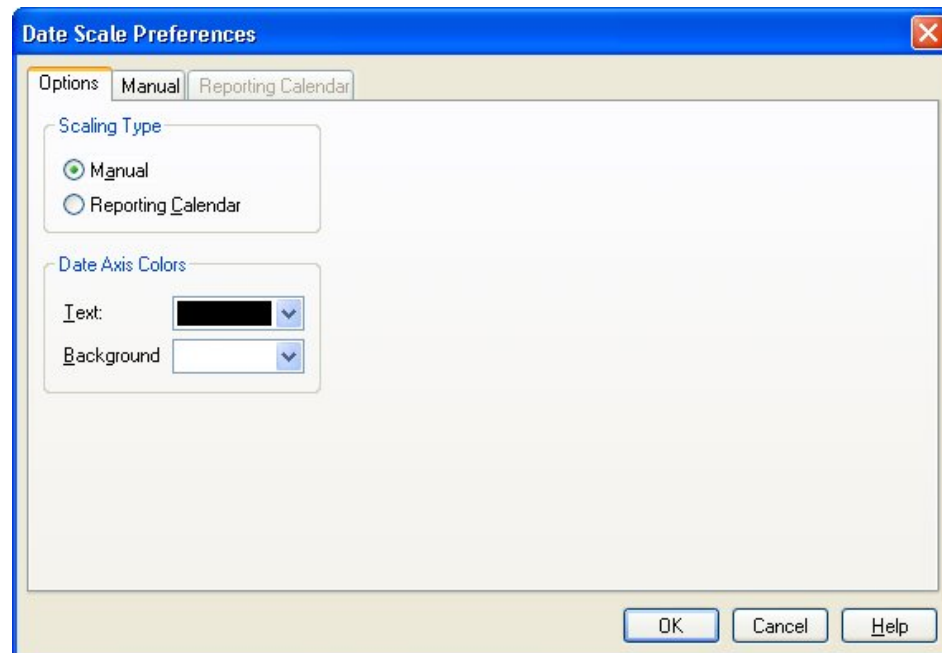

You can use this dialog box to control the text and background color for the date scale.

You can also manually adjust the spacing of any date scale by dragging within the date scale area.

To display the Date Scale Preferences dialog box

1. Open the appropriate barchart view.
2. Take one of the following actions:
 - On the **View** menu, click **Edit Date Scale**.
 - Right-click anywhere in the date scale, and click **Edit Date Scale** on the context menu.

Defining a Date Scale Manually

To define the appearance of a date scale manually, click the **Manual** option on the **Options** tab of the **Date Scale Preferences** dialog box. You can then display the **Manual** tab:

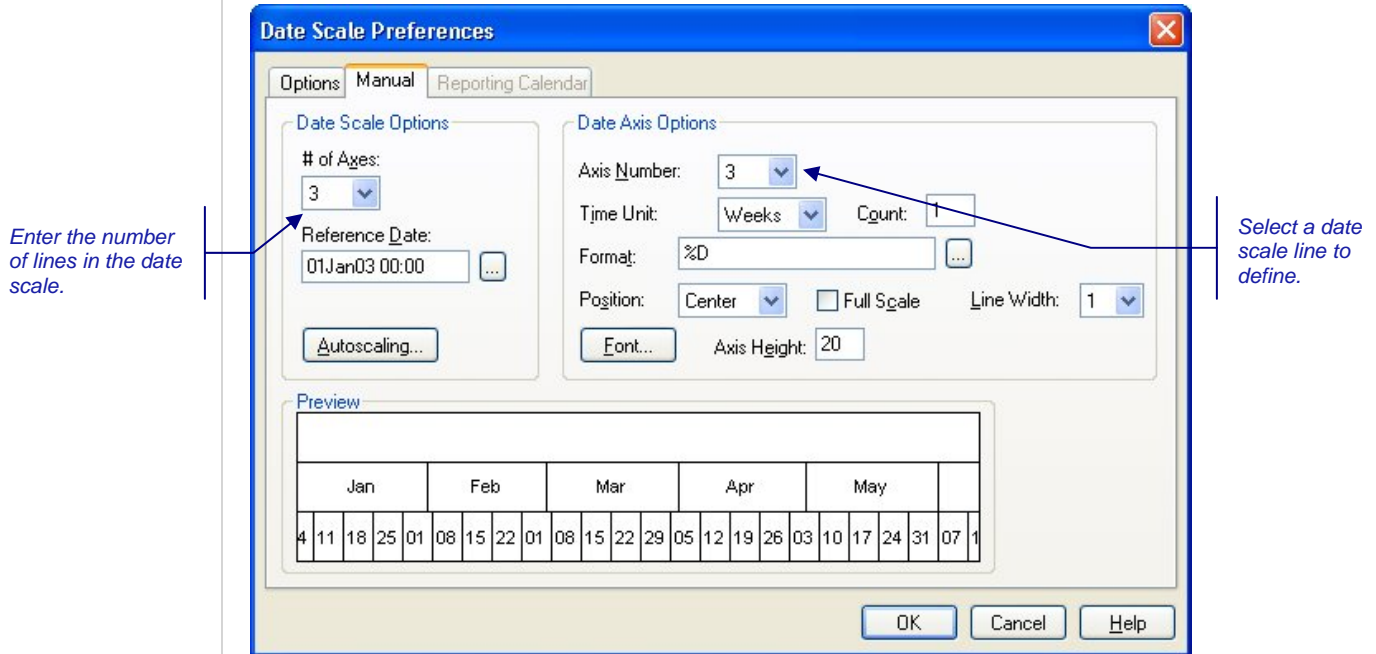

Use the **# of Axes** setting to specify how many lines you want to appear in the date scale. If you are displaying relative dates in one or more lines in the date scale, you can define a starting (reference) date for these labels.

You can define up to six different lines for a date scale. For each line, you can control the following options:

- **Time Unit** — To determine the frequency with which date labels and vertical tick marks appear on the date scale, select a time unit from the list. Possible units include: hours, days, weeks, months, quarters, and years.
- **Count** — You can specify a multiple for the selected time unit. This allows you, for example, to define an axis with labels for each two week period.
- **Format** — You can specify the appearance of the dates in the date scale by defining a date format. To define a format, click the **ellipsis** button next to the **Format** field, and select a format from the **Date Formats** dialog box, or enter the format manually using one or more of the following parameters:

Parameter	Definition	Example
%T	Minute	15
%H	Hour	08
%Z	AM or PM	A or P
%OZ	am or pm (lower case)	a or p

Parameter	Definition	Example
%D	Day of the month	31
%V	Day	Tuesday
%OV	Day (lower case)	Tuesday
%UV	Day (upper case)	TUESDAY
%W	Day abbreviation	Tues
%OW	Day abbreviation (lower case)	tues
%UW	Day abbreviation (upper case)	TUES
%K	Numeric week	22
%M	Numeric month	10
%L	Month	October
%OL	Month (lower case)	october
%UL	Month (upper case)	OCTOBER
%A	Month abbreviation	Oct
%OA	Month abbreviation (lower case)	oct
%UA	Month abbreviation (upper case)	OCT
%Q	Numeric quarter	4
%C	Year	2004
%OL	Month (lower case)	october

You can combine parameters to define date formats. You can also include spaces and literal characters in the format, as shown in the following examples:

Format	Example
%H:%T %Z.M.	07:15 P.M.
%W %D %A %H:%T	Mon 15 Sep 19:15
%M/%D/%C	09/15/2004

Format	Example
Q%Q	Q1



To show hours and minutes using the 24-hour (military) convention, do not use the %Z or the %OZ parameter in the definition of the format.

To display relative dates in a date scale, use the following parameters:

Parameter	Definition
%R%H	Relative hours
%R%D	Relative days
%R%K	Relative weeks
%R%M	Relative months
%R%Q	Relative quarters
%R%Y	Relative years



The values displayed for dates using a relative format are based on the **Reference Date** setting on the **Manual** tab of the **Date Scale Preferences** dialog box. To have Open Plan convert the currently selected date format to a relative date format, select the **Relative to Reference Date** option in the **Date Formats** dialog box.

All of these different types of format parameters can be combined with literal characters to produce the following types of labels:

Format	Example
%R%H Hours	100 Hours
Day %R%D	Day 3
Week %R%K	Week 15
FY%R%Y	FY1

- **Position** — This setting positions the label left-justified, right-justified, or centered within the vertical tick marks.
- **Full Scale** — To extend the vertical tick marks on the scale into the area containing the bars, select **Full Scale**.



Open Plan always draws these tick marks behind bars, relationships, and bar text.

- **Line Width** — You can specify the width of the lines in the date scale.
- **Font** — You can define the text font, size, and style for the scale by clicking **Font**.
- **Axis Height** — Enter the height for the date scale line in 1/100ths of an inch.

To define a date scale manually

1. Take one of the following actions:

On the **View** menu, click **Edit Date Scale**.

Right-click the date scale or the histogram portion of the view, and click **Edit Date Scale** on the context menu.

2. On the **Options** tab of the **Date Scale Preferences** dialog box, click **Manual**.

3. Click the **Manual** tab, and enter the information for each line in the date scale.

To display the settings for a specific line, select the line number in the **Axis Number** box, or click the line in the preview window.

4. When your changes are complete, click **OK** to return to the view.

Defining a Date Scale Using Autoscaling

The autoscaling feature in Open Plan allows you to automatically define a barchart date scale based on any of the following intervals:

- One week
- Two weeks
- One month
- Three months
- Entire project

You can also specify a custom interval to use with this feature.

Once you have indicated which interval to use, Open Plan automatically generates a date scale based on the width of the barchart pane and appropriate to the interval you specified. You can then further modify the date scale using the procedure described in the “Defining a Date Scale Manually” section in this chapter.

To define the appearance of a date scale using the autoscaling feature, click the **Manual** option on the **Options** tab of the **Date Scale Preferences** dialog box. You can then display the **Manual** tab:

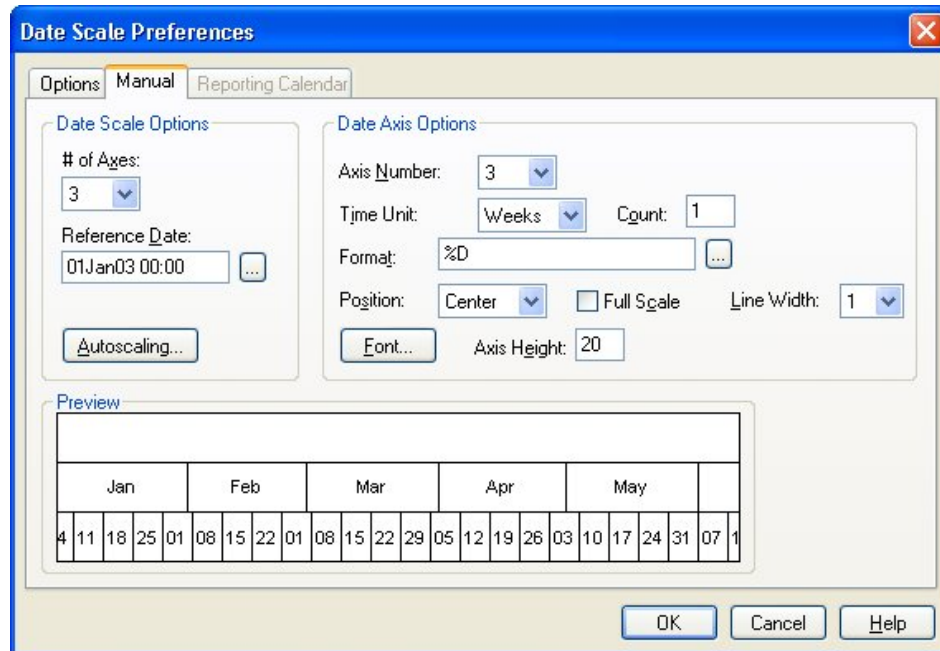

You can use the **# of Axes** setting to specify how many lines you want to appear in the date scale. Then click the **Autoscaling** command to display the following dialog box:

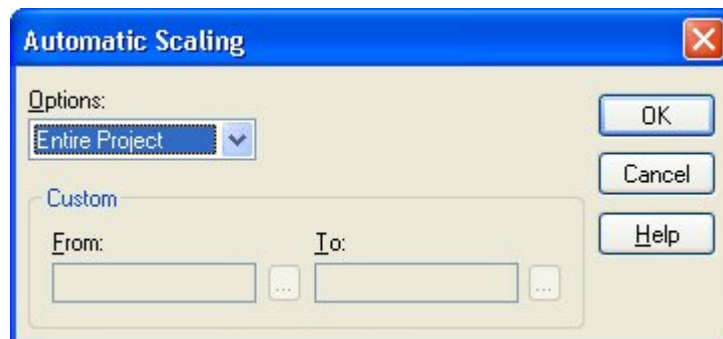

Use this dialog box to define the range of dates Open Plan should display on a single screen for autoscaling.

To define a date scale using Autoscaling

- Take one of the following actions:
 - On the **View** menu, click **Edit Date Scale**.
 - Right-click the date scale or the histogram portion of the view, and click **Edit Date Scale** on the context menu.
- On the **Options** tab of the **Date Scale Preferences** dialog box, click **Manual**.
- Click the **Manual** tab.
- Specify the number of axes you want to display in the date scale, and click **Autoscaling**.
- Select a range of dates for the operation, and click **OK**.

If you select **Custom**, you must enter a start and end date for the interval.

- When your changes are complete, click **OK** to return to the **Date Scale Preferences** dialog box.

Using Reporting Calendars

If you have set up one or more reporting calendars in order to display data using a non-linear time scale, you can base a date scale on this type of calendar. This allows you, for example, to create a “rolling wave” barchart report in which the units on the date scale can refer to different spans of time.

Week 1	Week 2	Week 3	Week 5	Week 7	Week 11	Week 15	Week 19	Week 30	Week 38	Week 45
--------	--------	--------	--------	--------	---------	---------	---------	---------	---------	---------

It is also possible to use multiple reporting calendars in a single date scale by assigning a different reporting calendar to each axis.

Week 1	Week 2	Week 3	Week 5	Week 7	Week 11	Week 15	Week 19	Week 30	Week 38	Week 45
Q_1				Q_2			Q_3		Q_4	

With multiple reporting calendars, however, you must designate one of the axes as the “controlling” axis that determines how Open Plan scales the other axes. Typically, the controlling axis displays the smallest intervals to be displayed in the date scale.

To use a reporting calendar to define the appearance of a date scale, you must have already defined the calendar using the **Reporting Calendars** command from the **Tools** menu. This command is available only in the Professional edition of Open Plan.



For information about creating reporting calendars, refer to Chapter 17, “Views and Reports.”

Once you have created a reporting calendar, click the **Report Calendar** option on the **Options** tab of the **Date Scale Preferences** dialog box. You can then display the **Report Calendar** tab:

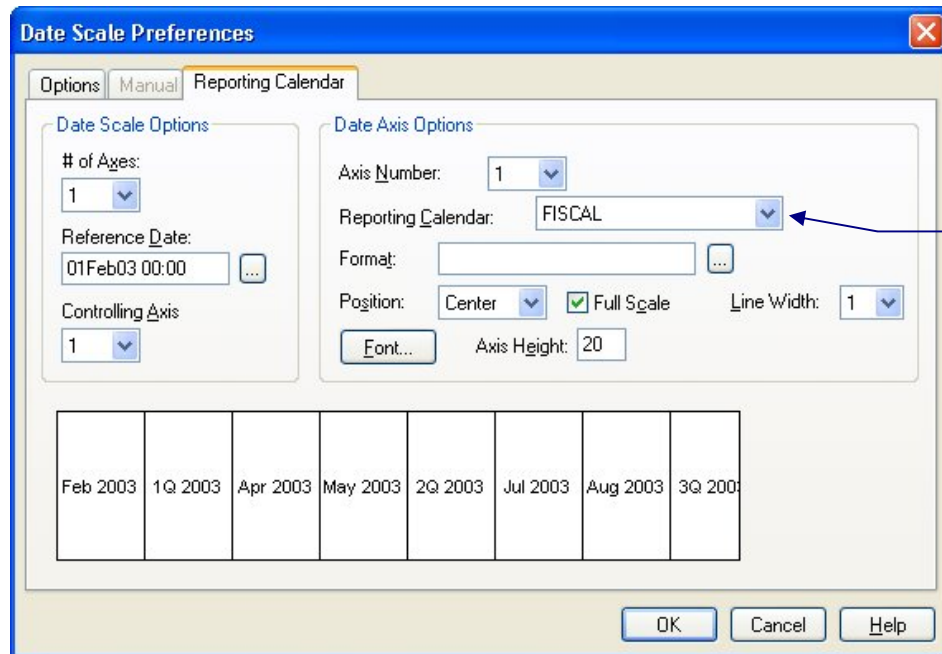

Use this tab to indicate the number of axes you want to appear in the date scale. If you are displaying relative dates in one or more lines in the date scale, you can define a starting (reference) date for these labels. If you want to use multiple axes in the date scale, you must specify which axis will control the scaling of the other axes.

For each axis you can define the name of the reporting calendar. You can also define how the labels from the reporting calendar appear with the following settings:

- **Format** — You can define the appearance of the dates using the formatting conventions described in the “Defining a Date Scale Manually” section in this chapter.
- **Position** — This setting positions the label left-justified, right-justified, or centered within the vertical tick marks.
- **Full Scale** — To extend the vertical tick marks on the scale into the area containing the bars, select **Full Scale**.



Open Plan always draws these tick marks behind bars, relationships, and bar text.

- **Line Width** — You can specify the width of the lines in the date scale.
- **Font** — You can define the text font, size, and style for the scale by clicking **Font**.
- **Axis Height** — Enter the height for the date scale line in 1/100ths of an inch.

To define a date scale with a reporting calendar

1. Take one of the following actions:
 - On the **View** menu, click **Edit Date Scale**.
 - Right-click the date scale or the histogram portion of the view, and click **Edit Date Scale** on the context menu.
2. On the Options tab of the Date Scale Preferences dialog box, click Reporting Calendar.
3. Click the Report Calendar tab, and assign one or more reporting calendars to the axes of the date scale.

You can also define how the labels in the date scale should appear.
4. When your changes are complete, click **OK** to return to the view.

Adjusting the Date Scale with a Mouse

Open Plan allows you to expand or compress the spacing of any date scale by simply dragging within the date scale area of the view:

August				September				
08/07	08/14	08/21	08/28	09/04	09/11	09/18	09/25	10/02

Drag to stretch or shrink the date scale.

With this feature, it is possible to make small adjustments to the date scale without having to redefine one or more of the elements making up the scale.



This feature also works on the **Manual** tab and **Reporting Calendar** tab of the **Date Scale Preferences** dialog box.

To adjust the date scale

1. Position the cursor over the date scale area of the view. The cursor shape changes to a double-headed arrow.
2. Drag to adjust the spacing of the date scale as follows:
 - To compress the date scale, drag to the left.
 - To expand the date scale, drag to the right.

Barchart Display Options

You can customize a barchart view by controlling the display of relationships, the Time Now marker, and non-work periods. You can access these controls from the **Barchart Preferences** dialog box:

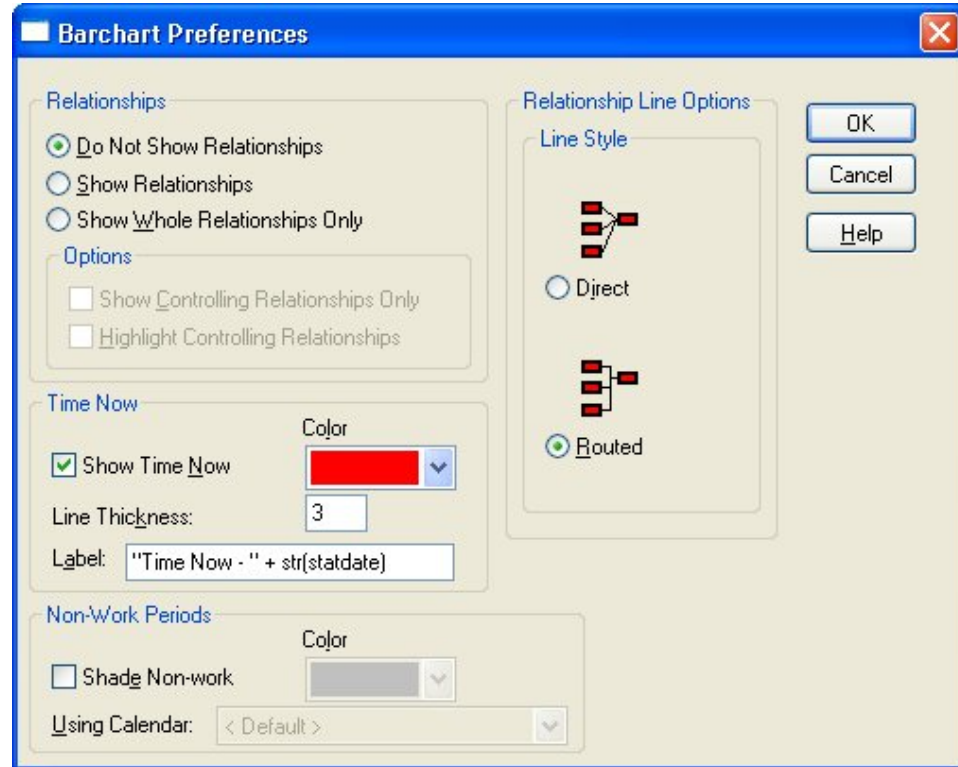

Open Plan provides the following options regarding relationships:

- **Do Not Show Relationships**
- **Show Relationships** — If a bar represents a summary of activities, Open Plan displays only those relationships external to the bar.
- **Show Whole Relationships Only** — Show relationships only if both the successor and predecessor are currently displayed in the view.

If you are displaying relationships in a view, you have the option to treat controlling relationships (that is, relationships with zero free float) in a special manner.

- You can show all relationships and display controlling relationships in the color of the successor activity bar. This normally results in highlighting the critical path in the view in red.
- You can highlight controlling relationships in blue.



For information about controlling relationships, refer to Chapter 8, “Time Analysis Calculations,” in the *Deltek Open Plan Developer’s Guide*.

Two relationship lines styles are available in barchart views:

- **Direct** — Allows diagonal relationship lines

- **Routed** — Restricts the display of relationships to either horizontal or vertical lines.

You can control the appearance of the Time Now marker using this dialog box. If you display a line for Time Now, you can specify:

- The color of the Time Now line and label
- The thickness of the line
- A label that Open Plan displays to the left of the line. You can also combine literal text with any project level field. For example, entering “**Time Now-** ” + **str(statdate)** will display **Time Now- 19Apr04**.



The date is displayed using the **Default Date Format** setting on the **Preferences** tab of the **Project Properties** dialog box. Also, literal text must always be entered within quotation marks (“”). **Statdate** is the field name for Time Now.

You can control the display of non-work periods by selecting **Shade Non-work**. If you select this option, Open Plan enables the following fields:

- **Color** — Allows you to select which color to use for shading
- **Using Calendar** — Allows you to specify the calendar that Open Plan should use when determining whether a particular time period should be shaded. If you do not select a calendar in this field, Open Plan uses the project default activity calendar.



You may need to change your date scale to show the appropriate work periods. For example, in order for a non-work week to be identified, the smallest level on the date scale must be no greater than weeks. Similarly, in order for non-work days, such as weekends, to be identified, the smallest level on the date scale must be no greater than days.

To customize display options

1. Take one of the following actions:
 - On the Tools menu, click Barchart Preferences.
 - Right-click an empty area in the barchart, and click Preferences on the context menu.
2. Enter the information for the display options.
3. When your changes are complete, click **OK** to return to the view.

Multi-Table Barcharts

Multi-table barcharts allow you to display both activity and resource bars and multiple baselines. Open Plan includes two standard multi-table barchart views: an activity/resource barchart, which groups resource assignments by activity, and a resource/activity barchart, which groups activity bars by resource assignment. Both types of views allow you to display time-phased cost data aggregated by the barchart date scale:

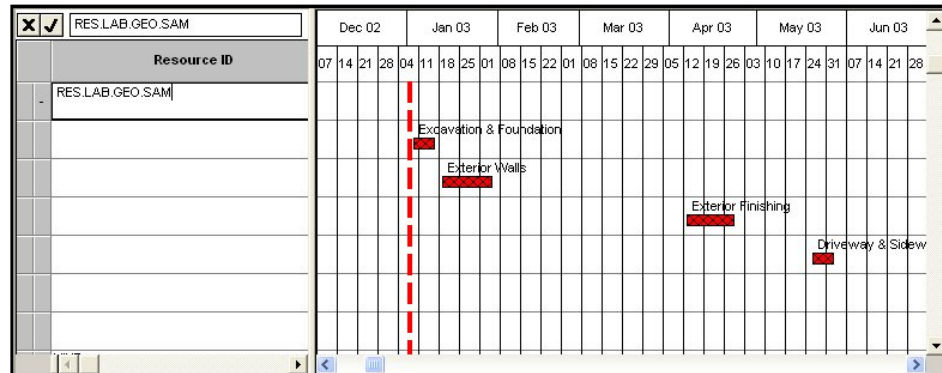

Resource bars based on early and late dates take into account assignment information such as offsets and periods. Bars based on scheduled dates display a single segment for each record of usage.

If you are using the Professional edition of Open Plan, you can control the display of resource and activity bars using the **Bar Attributes** tab of the **Bar Set Preferences** dialog box. To control the display of time-phased cost data, use the **Crosstable** tab of the **Bar Set Preferences** dialog box.



For information about customizing the appearance of resource bars and time-phased data in a multi-table barchart, refer to Chapter 6, "Customizing Barchart Views" in the *Deltek Open Plan Developer's Guide*.

To display the Bar Set Preferences dialog box

- Take one of the following actions:
 - From the barchart view, click **Bar Sets** on the **Tools** menu.
 - Right-click an empty area of the barchart view, and click **Bar Sets** on the context menu.
- From the **Bar Sets** dialog box, select the bar set to edit, and click **Edit**. The default bar set for the view is automatically selected.

19

Network Views

➤ Overview	441
➤ Controlling Box Sizes	442
➤ Network Legends	443
➤ Annotations	445
➤ Displaying Subprojects.....	448
➤ Automatic Placements	453
➤ Using the Zoom Commands	460
➤ Network Display Options.....	462
➤ Splitting the Network View	464

Overview

Favored by many experienced project planners, network views stress the clear depiction of relationships between activities and are often used to display a logical diagram of a project. Network views are particularly well suited for communicating the critical path of a project, which may have important ramifications for the execution of the overall project plan.

The network views in Open Plan are fully interactive and allow you to enter and update any type of project information. You can also customize the appearance of a network view in many areas:

- The size of activity boxes
- The appearance of view legends
- The display of text annotations
- The display of subprojects
- The placement of activities and relationships
- The zoning of activities based on one or more criteria
- The use of special display options

This chapter discusses the customization of a network view in each of these areas.



For information about customizing the display of activity boxes, refer to Chapter 7, "Customizing Network Views" in the *Deltek Open Plan Developer's Guide*.

Controlling Box Sizes

By default, Open Plan displays all activity boxes the same size. However, Open Plan allows you to customize the size of individual activity boxes in a view:

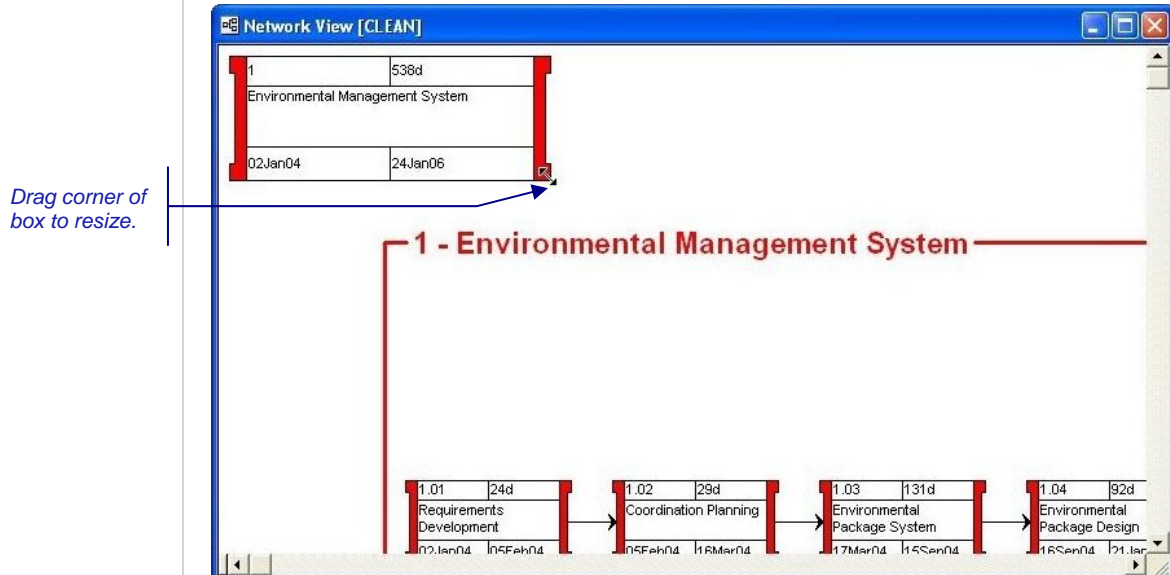

Open Plan also allows you to customize one activity box and then set all the boxes in the view to that size.

Once you have resized an activity box, you can use the following commands related to box sizes:

- **Reset Box Size** — Return the box size to the default setting.
- **Set All Box Sizes** — Set all box sizes in the view to the size of the customized box.

To resize an activity box

1. Position the cursor on the lower right corner of the activity box.
2. When the cursor changes shape to a double-headed diagonal arrow, drag the borders of the box to the desired size.



To return an activity box to the default size

1. Right-click an activity, and click **Reset Box Size** on the context menu.

To resize all activity boxes

1. Resize one activity box to the desired size.
2. Right-click the resized activity, and click **Set All Box Sizes** on the context menu.

Network Legends

Network views can include a legend that describes the various types of activity boxes appearing in the view as well as a definition of the activity data appearing in each box.

Legends are not normally displayed on the screen but are produced when the view is output to devices such as printers or plotters. You can, however, display the legend by using either a special option to place the legend manually or by using the **Print Preview** command from the **File** menu.

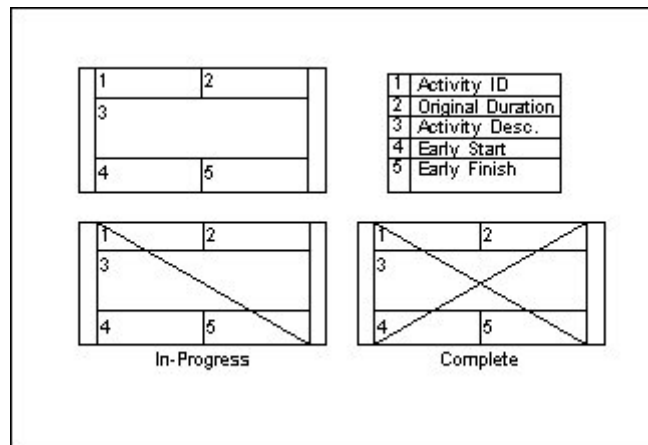

Open Plan provides a number of options for the placement and contents of a network legend. To set these options, click the **Legend** tab on the **Network View Preferences** dialog box:

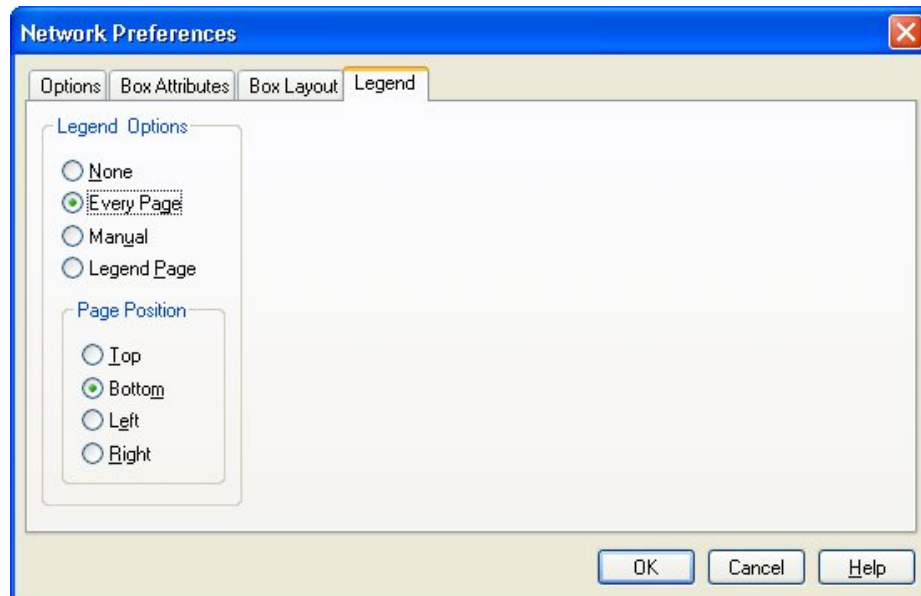

If you choose to display the legend on every page, Open Plan allows you to specify if the legend should appear on the top, bottom, left, or right side of the page. You can also choose to output the legend to a separate legend page.

The **Manual** option provides the most flexibility for displaying the legend. If you select this option, Open Plan displays the legend box in the view and allows you to position it manually or resize it. If a legend is too large to appear on a single page,

you can place the legend across page breaks so that it appears on two or more pages.



Another way to customize a legend is to use the **Manual** option to display the legend in the view and then use the annotation feature to add additional information such as the name of the project or a signature block. For information about network annotations, refer to the “Annotations” section in this chapter.

To customize a legend

1. Take one of the following actions:
 - On the **Tools** menu, click **Preferences**.
 - Right-click an empty area within the view, and click **Preferences** on the context menu.
2. On the **Network View Preferences** dialog box, click the **Legend** tab.
3. Enter the information for the legend.
4. When your changes are complete, click **OK** to return to the view.

To position a legend manually

1. Take one of the following actions:
 - On the **Tools** menu, click **Preferences**.
 - Right-click an empty area within the view, and click **Preferences** on the context menu.
2. On the **Legend** tab of the **Network View Preferences** dialog box, click **Manual**.
3. To return to the view, click **OK**.

Open Plan displays the legend in the lower left corner of the view. (You may need to use the **Zoom Out** command to determine the location of the legend.)

4. Position the legend manually as follows:
 - To move the legend, position the cursor on the legend frame. When the cursor shape changes to a hand, drag the legend to the desired location.
 - To resize the legend, position the cursor on the lower right corner of the legend frame. When the legend shape changes to a double-headed arrow, drag the frame to the desired size and shape.



Move cursor



Move cursor



If no boxes appear in a legend, enlarge the area of the legend by resizing it.

Annotations

Another way you can customize a network view is to add an annotation. The annotation feature allows you to store and display simple text objects on a project-specific basis:

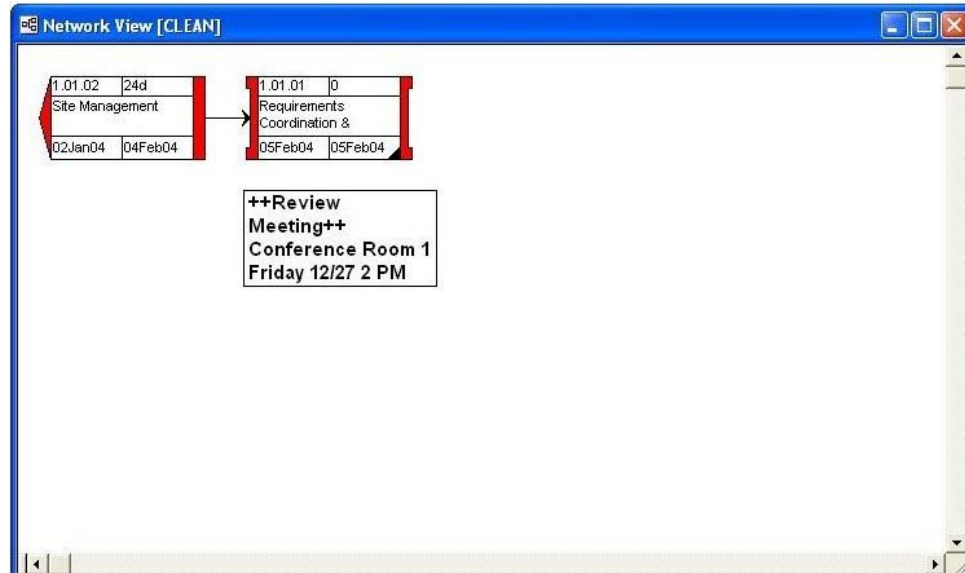

As an option, you can attach an annotation to an activity. When attached, an annotation maintains the same position relative to the activity, even if the activity moves. If you delete the activity, Open Plan deletes the annotation.



Only one annotation can be attached to an activity at a time. If you attach a new annotation to an activity that already has an annotation, the existing annotation will remain displayed but will no longer be attached to the activity.

To define an annotation, use the **Add Annotation** command on the **Edit** menu to display the following dialog box:

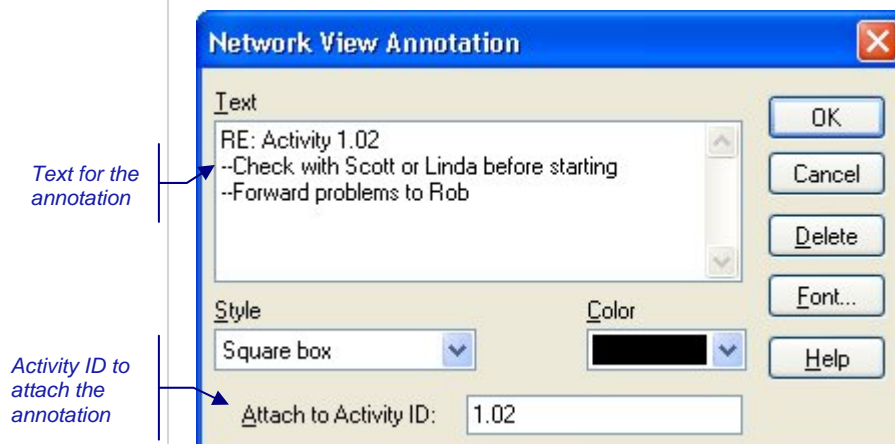

Annotations can contain multiple lines of text. To insert a line break in annotative text, press **Ctrl+Enter**. It is also possible to cut or copy text from an annotation to the Clipboard as well as to paste text from the Clipboard into an annotation.

In addition to the text for the annotation, you can specify the following settings:

- **Style** — Four options are available for the border style of the annotation:
 - No Border
 - Square Box
 - Round Box
 - Ellipse
- **Color** — You can define the background color of the annotation. If you select **No Border** for the annotation, this setting controls the color of the annotation text.
- **Font** — You can define the font used for the annotation text.



Adjusting the size of the annotation can change the font size.

- **Attach to Activity ID** — You can assign the annotation to any activity currently displayed in the view.

Once you have created an annotation, you can move it or resize it using the mouse. You can also use commands to display the annotation behind other objects, to edit its contents, or to delete it.

To create an annotation

1. Take one of the following actions:
 - On the **Edit** menu, click **Add Annotation**.
 - Right-click an empty area or an activity in the view, and click **Add Annotation** on the context menu.
 - Right-click an activity, and click **Annotate Activity** on the context menu.
2. In the **Network View Annotation** dialog box, enter the information for the annotation.

To attach an annotation to an activity, enter the activity ID in the appropriate field.

If you access the dialog box by right-clicking an activity, the Activity ID is automatically entered in the appropriate field.
3. When the information is complete, click **OK**.

To move an annotation

1. Position the cursor over the annotation.
2. When the cursor shape changes to a hand, drag the annotation to the desired location.

To resize an annotation

1. Click the annotation to select it.
2. When a rectangle appears around the annotation, drag the lower right corner of the rectangle to resize the annotation.



Move cursor

To modify an annotation

1. Right-click the annotation.
2. Click one of the following commands on the context menu:
 - To display the annotation behind other objects in the view, click **Send to Back**.
 - To display the **Network View Annotation** dialog box, click **Edit**.
 - To delete the annotation, click **Delete**.

Displaying Subprojects

By default, network views display only one hierarchical level at a time. However, it is possible to show multiple levels of a hierarchical project simultaneously in Open Plan:

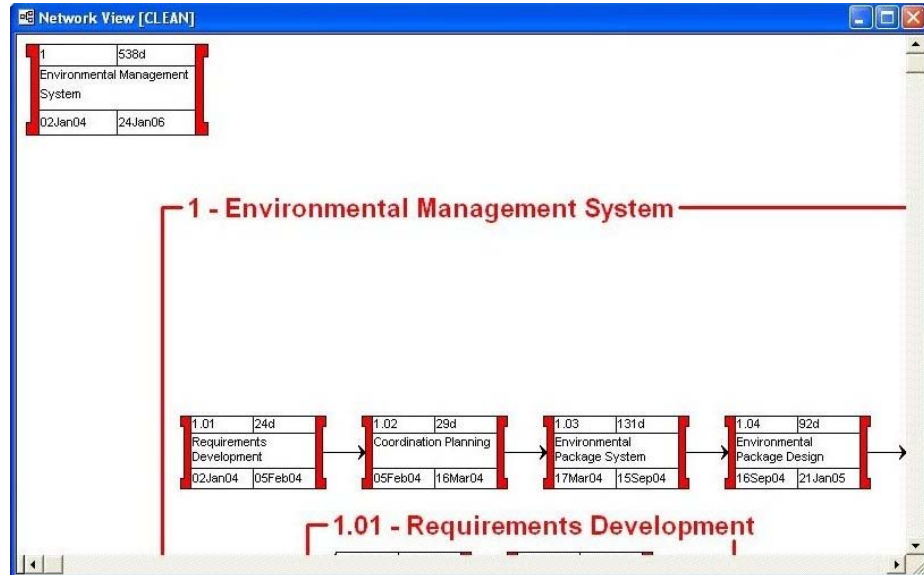

Features related to the display of hierarchical projects work identically for projects containing both internal and external subprojects.



You can use automatic placements to display activities from all levels in a format slightly different from that illustrated above. For more information, refer to the “Automatic Placements” section in this chapter.

By default, Open Plan positions an expanded subproject just below any activities already displayed. (On large projects, you can use the **Zoom** commands to see the rectangle containing the subproject.) Once you have expanded a subproject, however, you can move it by dragging it to a new position within the view. If you wish, you can turn off the display of the frame surrounding the subproject. You can also collapse any subproject by right-clicking within the subproject area and clicking the **Collapse Subproject** command.



The position of an expanded subproject is not saved between sessions. If you close a view and reopen it, you must expand and reposition any subprojects you adjusted in the previous session. However, Open Plan does save information about the drill-down level when you save the view using the **Save View** command. Thus, if you drill down to a specific subproject and then save a network view, Open Plan automatically drills down to the same subproject the next time you open the view.

When you display expanded subprojects in a view, you can draw relationships between activities both within an expanded subproject and to activities outside of the subproject area.

Relationship
between activities
in different
subprojects

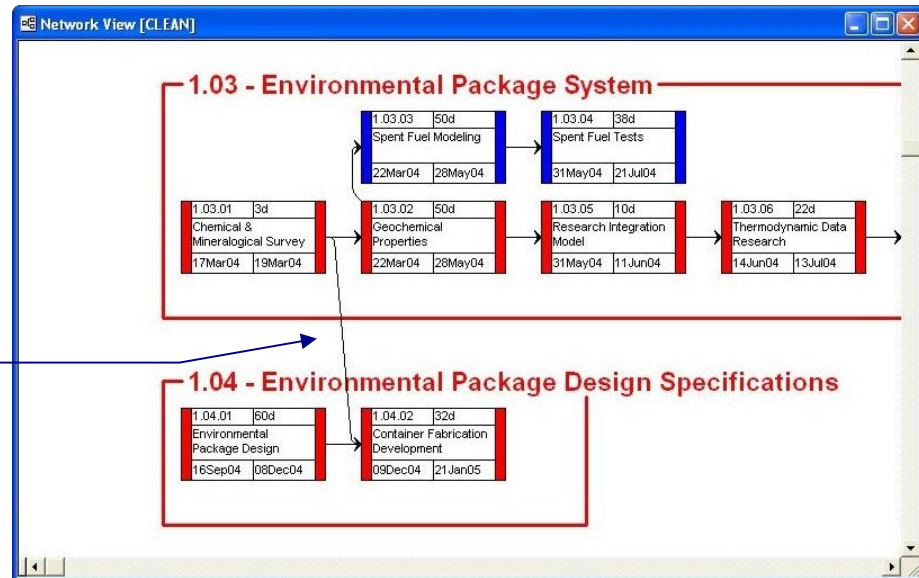

For information about creating relationships in a network view, refer to Chapter 6, "Activity Information."

Items such as activities, relationships, and annotations displayed in an expanded subproject do not behave identically to the same items displayed at the current level of the view. For example, you can continue to edit activities, relationships, and annotations appearing in the subproject by right-clicking the item you want to update. However, you cannot reposition these items within the subproject area or drag them outside of the subproject area.

To expand a subproject

1. Select the parent activity of the subproject you want to expand.
2. Take one of the following actions:
 - On the **View** menu, click **Expand**.
 - Right-click the activity, and click **Expand** on the context menu.
 - On the toolbar, click the **Expand** button.



Expand button

To expand all subprojects

1. Take one of the following actions:
 - On the **View** menu, click **Expand All**.
 - On the toolbar, click the **Expand All** button.



Expand All button

To move an expanded subproject

1. Position the cursor on the frame of the subproject you want to move.
2. When the cursor shape changes to a hand, drag the subproject to the desired position.



Move cursor

To collapse a subproject

1. Right-click the subproject area, and click **Collapse Subproject** on the context menu.

To collapse all subprojects

1. Take on of the following actions:
 - On the **View** menu, click **Collapse All**.
 - On the toolbar, click the **Collapse All** button.

To suppress the frame around a subproject

1. Right-click the subproject area, and clear **Display Subproject Frame** on the context menu.

Displaying Multiple Subprojects

Displaying expanded subprojects from multiple hierarchical levels usually requires the use of two commands:

- **Go To Subproject** — Drill down to the next level of the project. The level from which you drilled down is no longer displayed in the view.
- **Expand** — Maintain the current level of the view, but display the children of the selected activity as an expanded subproject.

To understand how you might use these commands to expand subprojects from different levels, assume that you want to represent the following project in a single network view:

Activity ID	Description
1	Project
1.1	Subproject 1
1.1.1	Detail activity 1
1.1.2	Detail activity 2
1.2	Subproject 2

When you first display this project in a network view, only the top level activity appears:

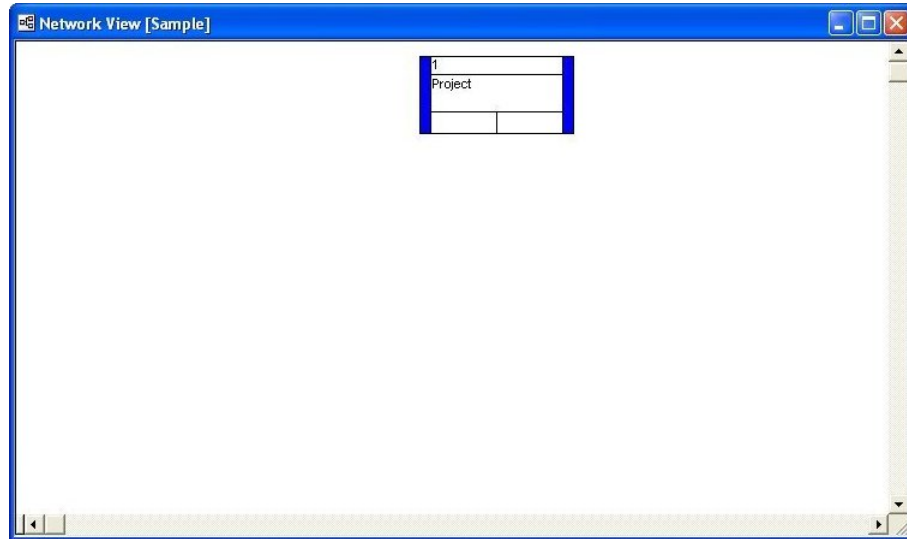

By selecting this activity and clicking **Expand**, you can display the following:

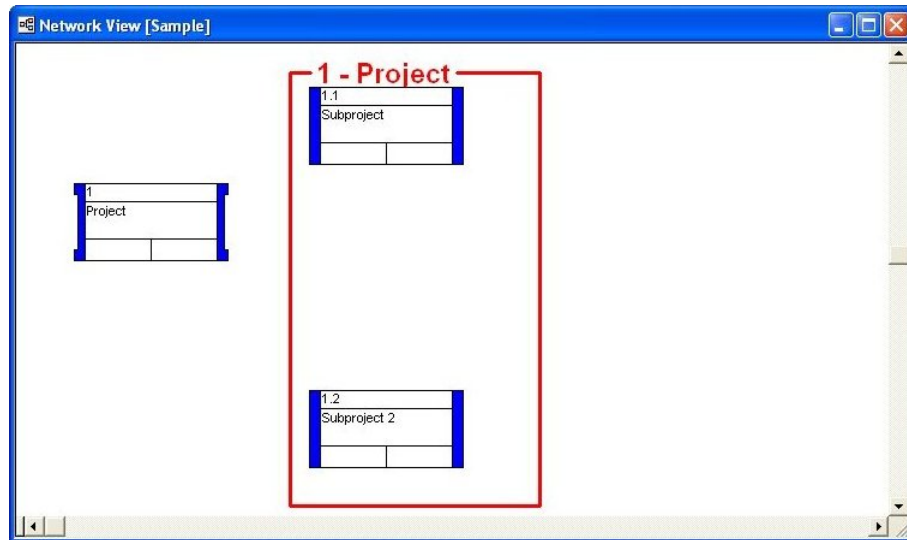

To display the detail activities in the project, you must first drill down a level and expand Subproject 1:

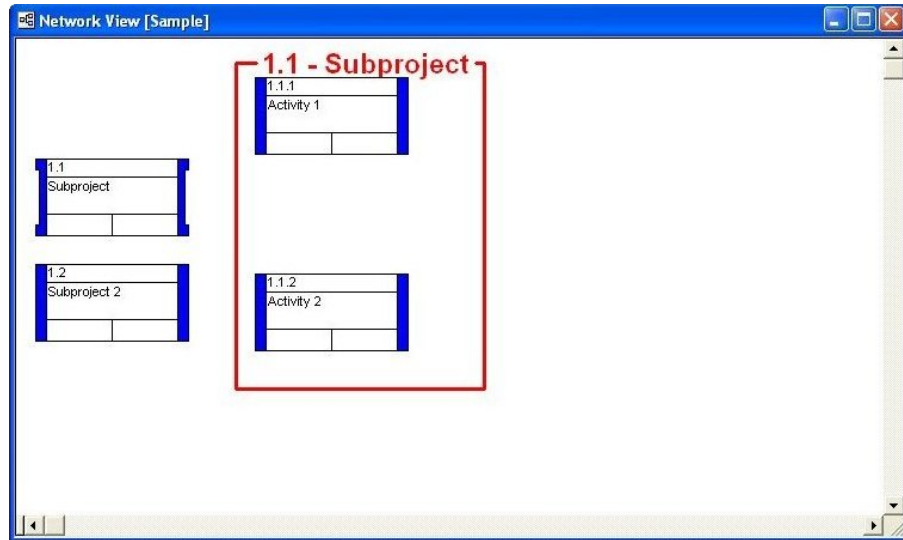

Once you have displayed the lowest level of detail in the project, click the **Go To Top Level** command to display all of the expanded subprojects in the same view:

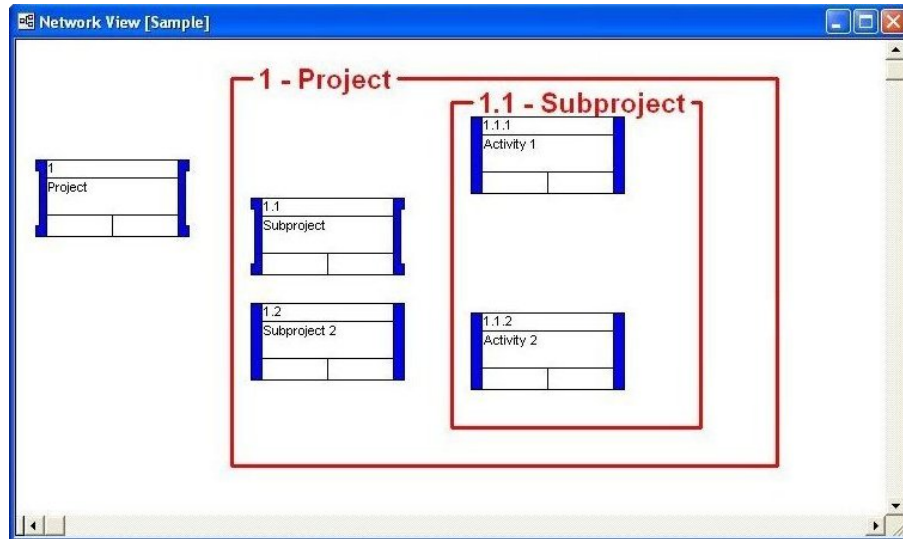

Automatic Placements

In network views, the term “placements” refers to the positioning of activities and relationship lines. You can position activities in a view manually, or you can have Open Plan calculate placements automatically using an algorithm designed to minimize the need for relationship lines to cross each other. Placements calculated in this fashion can result in network diagrams that are much easier to decipher, particularly in the case of very large projects.

Initially, the position of an activity in a network view depends on how you create it:

- If you add an activity by double-clicking in the view or by drawing a relationship from an existing activity, Open Plan places the activity in the position you indicated.
- If you create an activity using the **Add Activity** command, Open Plan places it in the middle of the current view.
- If you create an activity in a view other than a network view, Open Plan places the new activity below the existing activities when you return to the network view.



You cannot change the size of an activity box while placements are set to automatic.

If you choose to have Open Plan calculate placements automatically, you can control these calculations with options to avoid displaying activities across page breaks, to show activities from all hierarchical levels of the project, to filter the activities displayed, or to arrange activities either in zones based on the contents of an activity field such as a code or along a time scale.

In addition to allowing for options such as filters, zoning, and time-scaling, automatic placements differ from manual placements in how Open Plan preserves the placement information for the view between sessions. For automatic placements, Open Plan stores your settings for how the placements are calculated. It does not, however, store the actual placements themselves. Placements are recalculated each time the view is opened.

If you perform automatic placements and want to preserve them for future sessions, you can save them as manual placements. You also have the ability to perform automatic placement calculations and then make adjustments to the activity positions manually. You can then save these modified automatic placements if you want to preserve them between sessions.

Open Plan stores placement settings separately for each network view assigned to a project. This means, for example, you can define one set of placement options for FLOWVW in the project Clean, and another set for DEVFLOW (another network view) in the same project. You can also define different placement settings for these same views when they are opened within a different project.



Open Plan does save the state of the automatic placements option (enabled or disabled) when you save the view using the **Save View** command. Thus, if you save a network view with automatic placements on, Open Plan automatically calculates placements for the view the next time you open it.

The **Placements** dialog box controls the operations of the placements feature.

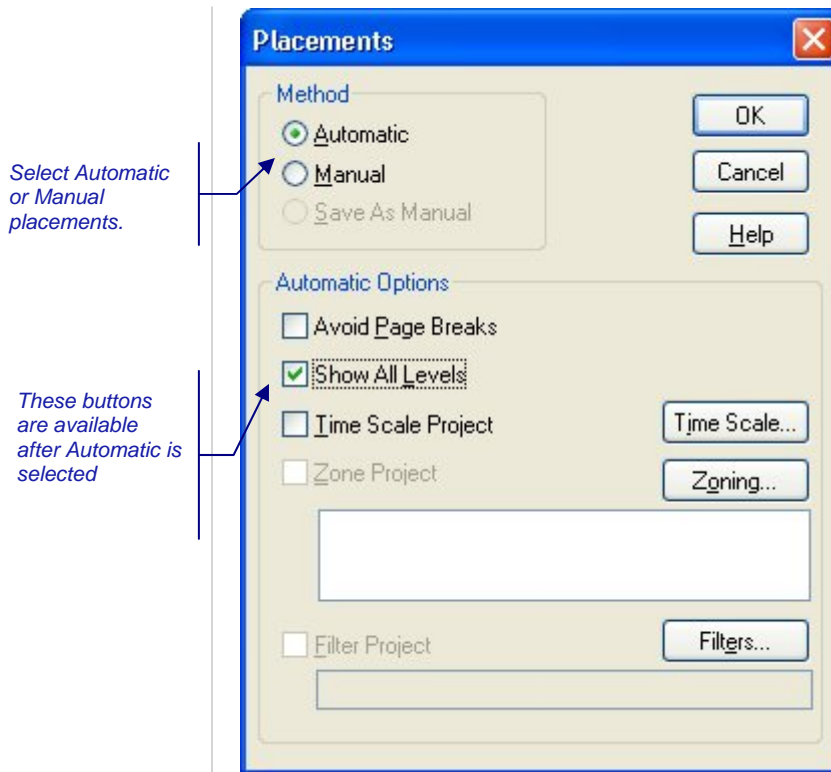

The following settings control automatic placement calculations:

- **Automatic** — This option calculates placements automatically. Once you have performed automatic placements, you can modify the view manually.



When calculating automatic placements, Open Plan positions all isolated activities (that is, activities that do not have relationships with other activities) in one or more rows below any activities with relationships.

- **Manual** — This option turns off automatic placements and returns the view to the last manual placements.
- **Save As Manual** — If you have performed automatic placements and remain in the automatic placements mode, you can save the current set of placements by clicking this option. When you select this feature, Open Plan returns to the manual placements mode.



The **Save As Manual** option is available only when automatic placements are in effect and filtering is not enabled.

- **Avoid Page Breaks** — If you have enabled automatic placements, this option controls how Open Plan positions activities that fall across page breaks of printed output. By selecting this setting, you can have Open Plan shift activities that would otherwise fall across page breaks.
- **Show All Levels** — If you have enabled automatic placements, this option displays all the activities from a project in the same view, regardless of their hierarchical level. When you calculate placements with this option turned on, Open Plan may not position all activities from the same subproject together.

- **Time Scale Project** — If you have enabled automatic placements, this option groups activities based on a user-specified date field.
- **Time Scale** — Click this button to display the **Scaling Specifications** dialog box that you can use to define the time scaling parameters Open Plan uses when you select the **Time Scale Project** option.



For information about setting up time scaling, refer to the “Defining Time Scaling” section in this chapter.

- **Zone Project** — If you have enabled automatic placements, this option places activities in zones based on user-defined criteria.
- **Zoning** — Click this button to display the **Zone Attributes** dialog box that you can use to define how Open Plan displays zones when you select the **Zone Project** option.



For information about setting up time scaling, refer to the “Defining Time Scaling” section in this chapter.

- **Filter Project** — If you have enabled automatic placements, this option allows you to assign a filter to the view.
- **Filters** — Click this button to display the **Filters** dialog box that you can use to define the filter Open Plan uses when you select the **Filter Project** option.



For more information about view filters, refer to Chapter 24, “Project Utilities.”

To perform automatic placements

1. Take one of the following actions:
 - On the **View** menu, click **Placements**.
 - Press **Shift+P**.
 - Right-click an empty area of the view, and click **Placements** on the context menu.
2. In the **Placements** dialog box, click **Automatic** for the placements method
3. Select the desired option(s) for the operation.
4. Click **OK**.

Open Plan responds by returning to the view and calculating new placements for the activities and relationships.



If you perform automatic placements with the **Relationship Line Options** set to **Direct** in the **Network View Preferences** dialog box, Open Plan staggers the display of relationship lines where necessary to avoid any ambiguity.

To turn automatic placements off

1. Take one of the following actions:
 - On the **View** menu, click **Placements**.

- Press **Shift+P**.
 - Right-click an empty area of the view, and click **Placements** on the context menu.
2. In the **Placements** dialog box, click **Manual**.
 3. Click **OK**.

Open Plan responds by turning automatic placements off and restoring the view to the last manual placements.

To save automatic placements

1. Perform automatic placements.

You can manually modify the placements calculated by Open Plan before saving them.

2. Display the **Placements** dialog box.
3. Click **Save As Manual**.
4. Click **OK**.

Open Plan responds by saving the current placements and returning to the manual placements mode.

Defining Custom Zoning

If you enable the zoning option for automatic placements, you can have Open Plan group activities in zones defined by criteria that you specify. For example, you can zone a project based on an activity code:

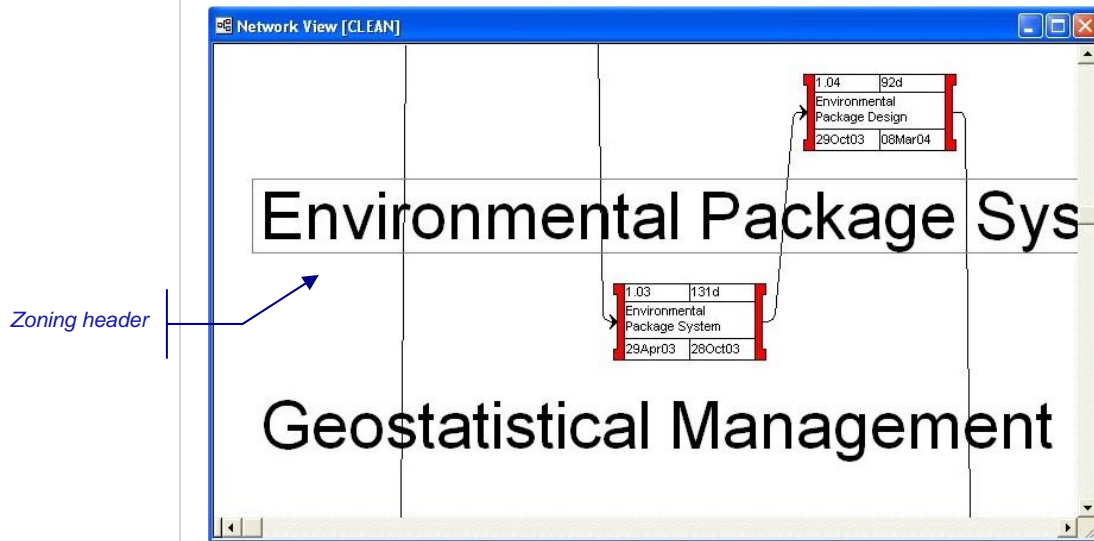

You can define as many as 50 zoning criteria for the calculation of automatic placements. To define how the view should be zoned, click **Zoning** on the **Placements** dialog box to display the **Zone Attributes** dialog box:

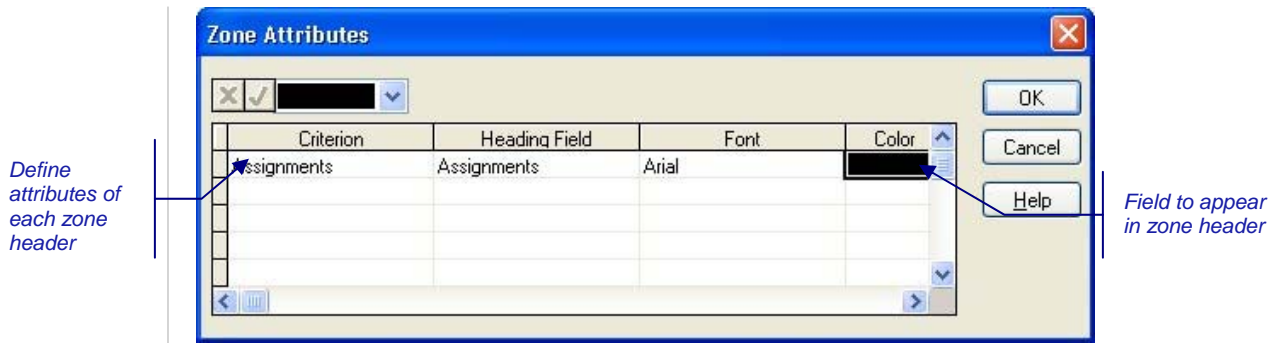

You can customize zone headings with the following settings:

- **Criterion** — Changes in this field trigger the appearance of a zone header in the view. You can designate a calculated field as a zoning criterion.
- **Heading Field** — The heading field specifies the field displayed by Open Plan in the zone header. For example, if you use a code field as a zoning criterion, you might use the code description for the heading field.
- **Font** — The font used for the zone header.
- **Color** — The color used for the zone header.



Once you define zoning and perform automatic placements, you can treat the zone headers as annotations to the view. In other words, you can edit, reposition, and resize zone headers just as you can annotations. You can also attach zone headers to activities so that a header moves with the specified activity.

To define custom zoning

1. On the **Placements** dialog box, click **Zoning**.
2. In the **Zone Attributes** dialog box, enter the information for each attribute.
To delete an attribute, delete the contents of the **Criterion** field for that attribute.
To define the font for a zoning header, select the **Font** field, and click the **ellipsis** button next to the edit box.
3. When your changes are complete, click **OK** to return to the **Placements** dialog box.

To adjust the position of a zone header

1. Position the cursor over the header.
2. When the cursor shape changes to a hand, drag the header to the desired location.



Move cursor

To resize a zone header

1. Select the zone header.
2. When a rectangle appears around the header, drag the lower right corner of the rectangle to resize the header.

To modify a zone header

1. Right-click the zone header.

2. Click one of the following commands on the context menu:
 - To display the header behind other objects in the view, click **Send to Back**.
 - To display the **Network View Annotation** dialog box for the header, click **Edit**.
 - To delete the header, click **Delete**.

Defining Time Scaling

If you enable the time scaling option for automatic placements, you can have Open Plan group activities based on activity dates. For example, you can group activities in a project based on early start dates:

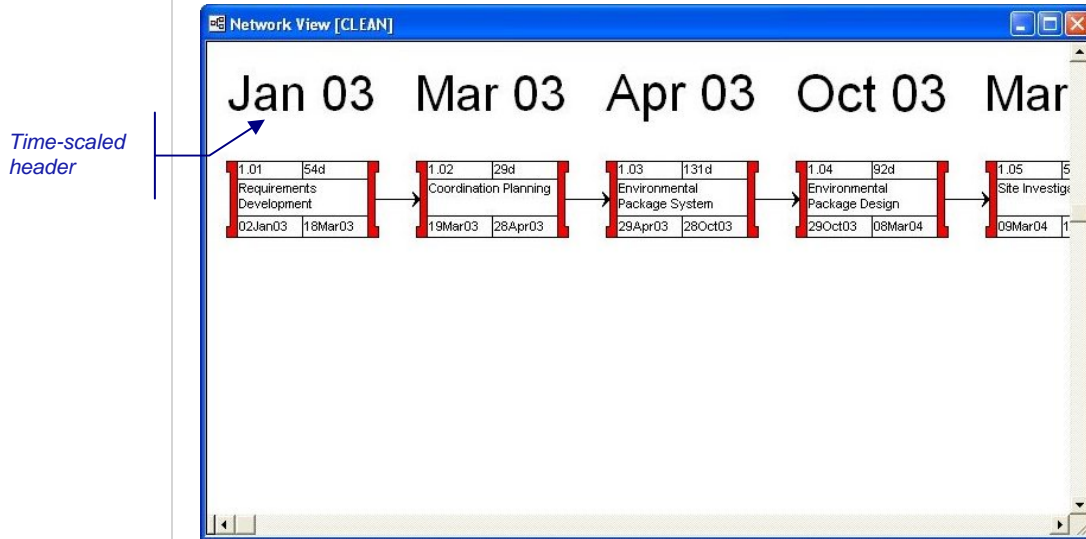

To define how the view should be time-scaled, click the **Time Scale** button on the **Placements** dialog box to display the **Scaling Specification** dialog box:

You can customize time scaling with the following settings:

- **Base on Date Field** — You can select any activity date field as the basis of time scaling.
- **Group Every** — You can specify the granularity of the time scale.
- **Date Format** — You can use this setting to define the format used by Open Plan when generating the time scale headers.



For a complete description of date formats in Open Plan, refer to the “Defining a Date Scale Manually” section in Chapter 18, “Barchart Views.”

- **Reference Date** — If you have specified a date format that includes relative dates, use this setting to define the reference date.
- **Font** — The font used for the time-scaled header.



As in the case of zoning, once you define time scaling and perform automatic placements, you can treat the headers as annotations to the view. In other words, you can edit, reposition, and resize time-scaled headers just as you can annotations.

To define custom time scaling

1. On the **Placements** dialog box, click **Time Scale**.
2. In the **Scaling Specification** dialog box, enter the information for the operation.

To define the font for the time-scaled headers, select the **Font** field, and click the **ellipsis** button next to the edit box.

3. When your changes are complete, click **OK** to return to the **Placements** dialog box.

To adjust the position of a time-scaled header

1. Position the cursor over the header.
2. When the cursor shape changes to a hand, drag the header to the desired location.

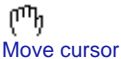

Move cursor

To resize a time-scaled header

1. Click the zone header to select it.
2. When a rectangle appears around the header, drag the lower right corner of the rectangle to resize the header.

To modify a time-scaled header

1. Right-click the zone header.
2. Click one of the following commands on the context menu:
 - To display the header behind other objects in the view, click **Send to Back**.
 - To display the **Network View Annotation** dialog box for the header, click **Edit**.
 - To delete the header, click **Delete**.

Using the Zoom Commands

In a network view, Open Plan provides a **Zoom In** and **Zoom Out** command for projects that cannot be displayed on a single screen.

There are three display modes for the network view:

- **Normal** — This is the default display mode when you first open a network view.
- **Intermediate** — This mode is displayed when you apply the **Zoom Out** command from the normal display mode.
- **Reduced** — This mode is displayed when you apply the **Zoom Out** command from the intermediate display mode.

In the intermediate display mode, the activity boxes are reduced so that only the first activity field in the box is visible:

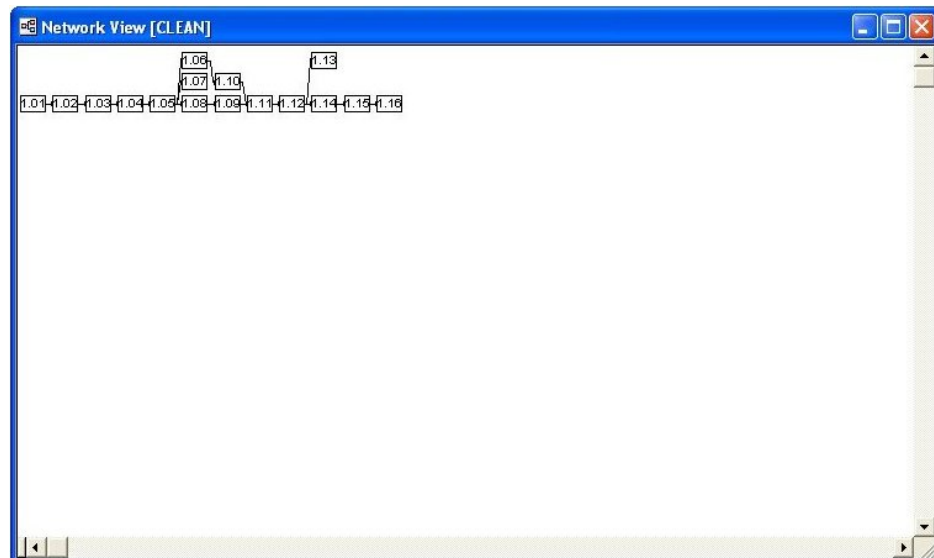

In this intermediate display mode, you can continue to work with the activities and relationships just as though you were in the normal display mode. To enlarge an area of the window, select an activity, and apply the **Zoom In** command.

If you apply the **Zoom Out** command from the intermediate display mode, Open Plan reduces the activity boxes to whatever size is necessary to display the entire project.

Drag this frame to zoom in on a specific area.

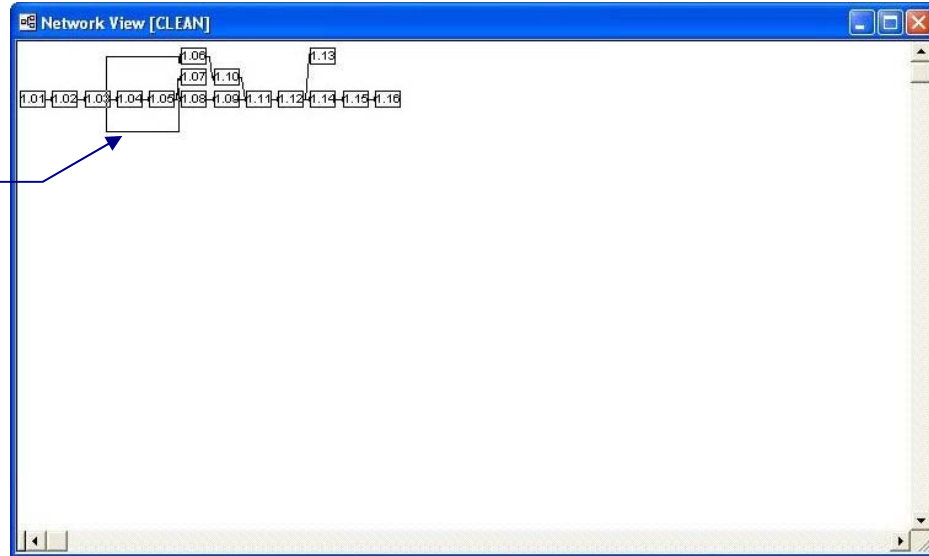

You can use this reduced display mode for navigating through very large projects. A rectangular frame appearing in this mode indicates the area of the view that will be displayed if you apply the **Zoom In** command to return to the intermediate display mode. To move this frame, simply drag it to the area of the project you want to examine at a higher magnification level.



If the entire project can be displayed at once, the **Zoom** commands are not available.

To apply the Zoom commands

1. Take one of the following actions:
 - In the normal display mode, click **Zoom Out** on the **View** menu.
 - In the intermediate display mode, click either **Zoom In** or **Zoom Out** on the **View** menu.
 - In the reduced display mode, click **Zoom In** on the **View** menu.

You can also invoke these commands by right-clicking an empty area of the view and clicking the appropriate command on the context menu, or you can invoke the appropriate command by clicking its corresponding button on the toolbar.



Zoom Out button



Zoom In button

Network Display Options

You can control the display of a network view with a number of settings accessed from the **Options** tab of the **Network View Preferences** dialog box:

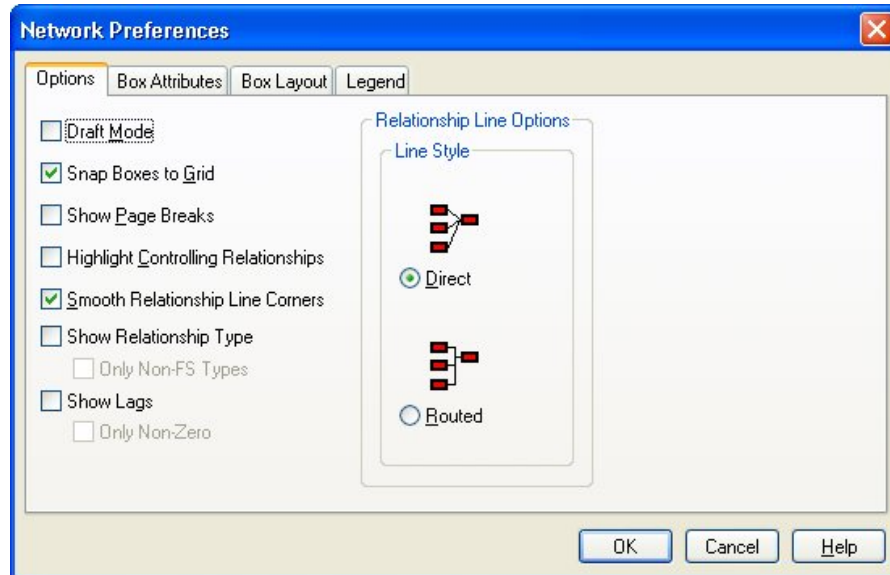

The settings for network display options are as follows:

- **Draft Mode** — Displays all activity boxes with black text, no box ends, no fill colors, and no diagonals.
- **Snap Boxes To Grid** — Forces both new activity boxes and boxes being moved to align themselves to an invisible grid in the view.
- **Show Page Breaks** — Displays lines indicating the boundaries of a page as defined by the current **Print Setup** command. (You can also control this setting with the **Show Page Breaks** command on the **View** menu.)
- **Highlight Controlling Relationships** — Highlights relationship lines that control the early dates of a successor activity. The highlighted relationship lines use the same color as the right end of the successor activity box and are thicker than standard relationship lines.
- **Smooth Relationship Line Corners** — Displays relationship lines using curves rather than angles.
- **Show Relationship Type** — Displays the relationship types between activities on the relationship line as follows:
 - **FS** — Finish to Start
 - **SS** — Start to Start
 - **SF** — Start to Finish
 - **FF** — Finish to Finish
 - **Only Non FS-Types** — Displays only SS, SF, and FF relationships on the relationship line. This option is enabled when you select **Show Relationship Type**.
- **Show Lags** — Displays the amount of lag between activities on the relationship line.

- **Only Non-Zero** — Displays only lags greater than zero. This option is enabled when you select Show Lags
- **Relationship Line Options** — Two relationship lines styles are available in network views: **Direct**, which allows diagonal relationship lines, and **Routed**, which restricts the display of relationships to either horizontal or vertical lines. Changing the relationship line style has no effect on lines that you have modified manually.

To customize display options

1. Take one of the following actions:
 - On the **Tools** menu, click **Preferences**.
 - Right-click an empty area within the view, and click **Preferences** on the context menu.
1. On the **Options** tab of the **Network View Preferences** dialog box, enter the information for the display options.
2. When your changes are complete, click **OK** to return to the view.

Splitting the Network View

Open Plan allows you to “split” a network view in two. Both panes function normally, and each is independent of the other. For example, scrolling one pane does not scroll the other.

There are three ways to split a network view:

- Clicking **Split View** on the **View** menu
- Double-clicking the splitter control.
- Using the split view cursor to drag the splitter bar to the desired location.

The splitter control is located at the left edge of the horizontal scrollbar.

Split view
cursor



Hovering the cursor over the splitter control displays the split view cursor.

This feature is handy when you have to add a relationship between two activities that are not located next to each other in a large network. To do so, display the predecessor in one pane and the successor in the other. Then **Alt**+drag the cursor from the predecessor to the successor.

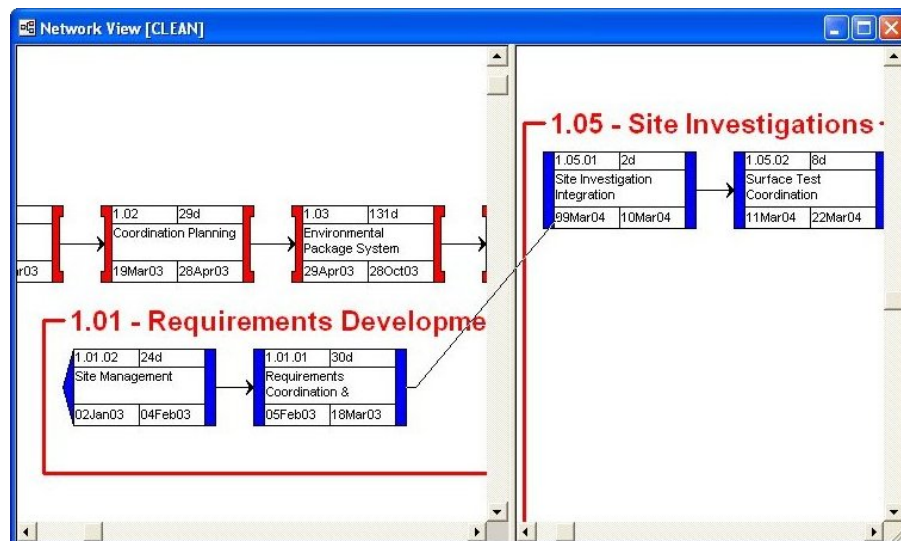

Once the link is created, both panes will show the new relationship line.



For more information on adding relationships, refer to Chapter 6, “Activity Information.”

To split the network view

1. Open the appropriate network view.
2. Take one of the following actions:
 - On the **View** menu, click **Split View**.



Split view cursor

- Double-click the splitter control located at the left edge of the horizontal scrollbar.
- Point to the splitter control, and use the split view cursor that is displayed to drag the splitter bar to the desired location.

To add a relationship using the split network view

1. Split the network view.
2. Display the predecessor activity in one pane and the successor activity in the other.
3. **Alt+**drag the add relationship cursor from the start or finish of the predecessor to the start or finish of its successor



Add Relationship cursor

20

Spreadsheet Views

➤ Overview	469
➤ Customizing Spreadsheet Columns.....	470
➤ Spreadsheet Display Options	475
➤ Support for All Tables.....	477
➤ Subsections.....	479
➤ Outlining	484
➤ Linking.....	488
➤ Modifying Hierarchal IDs Using Indent and Outdent.....	491
➤ Automatic Numbering within a Spreadsheet.....	492

Overview

Spreadsheet views display the information for multiple records in a tabular format. This makes these views well-suited for reports designed to show detail information at a relatively low level. Since they are fully interactive, spreadsheet views are also useful for data entry purposes, particularly in cases where large numbers of records are involved.

Open Plan uses a single-table spreadsheet to display information about activities. The spreadsheet can be based on any table. For example, to view resource assignments, you would base the spreadsheet on the resource table. You can also set up subsections or use outlining to display the appropriate level of information.

Open Plan also provides standard versions of multi-table spreadsheet views that can display information stored in different data tables.

You can customize all types of spreadsheets by defining the layout of data columns and setting a number of preferences that control the display of data in these views.

This chapter discusses each of the ways you can customize a spreadsheet view and applies to both stand-alone spreadsheets as well as the spreadsheet portion of barchart views.

Customizing Spreadsheet Columns

All Open Plan spreadsheet views allow you to customize the layout of columns in a number of ways:

- You can add or insert a column at a specific position.
- You can define the formatting for a column.
- You can delete a column.
- You can change the column width or heading.
- You can move the position of a column.

You can also customize columns in a spreadsheet view using a mouse.

Drag the column heading to reposition the column.

Activity ID	Activity Desc.	Duration	Activity Type	Early Dates	Late Dates	Total Float
1	Environmental Management System	572d	Subproject	02Jan03 15Mar05	08Jan03 15Mar05	0
1.01	Requirements Development	54d	Subproject	02Jan03 18Mar03	08Jan03 24Mar03	4d
1.01.01	Requirements Coordination & Planning	30d	External Subproject	05Feb03 18Mar03	11Feb03 24Mar03	4d
1.01.01.RES	Cleanup Resources	0	Subproject			0
1.01.01.RES.EQUIP	Equipment	0	Subproject			0
1.01.01.RES.EQUIP.CLEAN	Cleanup Equipment	0	Subproject			0
1.01.01.RES.EQUIP.CLEAN.1_09_02	Water Table Drillholes	0	ASAP	26Oct04 20Nov04	30Oct04 24Nov04	0
1.01.01.RES.EQUIP.TEST	Testing Equipment	0	Subproject			0
1.01.01.RES.EQUIP.TEST.1_02_01	Engineering Field Testing	0	ASAP	19Mar03 04Apr03	25Mar03 10Apr03	0
1.01.01.RES.EQUIP.TEST.1_03_06	Thermodynamic Data Research	0	ASAP	25Jul03 25Aug03	31Jul03 29Aug03	0

Drag the header boundaries to change the column width.

When you add or insert a new column or update an existing column, Open Plan displays the following dialog box:

Click for automatic sizing.

Enter column width in characters.

Table Name: Activity

Field Name: Accomplished_Duration

Title: Accomplished_Duration

Wrap Text: In cells, In column heading

Width: Best Fit, Specific: 27

Text: Indent, Override Default Font Settings, Italic, Bold

Alignment: < Default >, Color: < Default >

Formatting: < Default >, Minutes, Hours, Days, Weeks, Months

Decimals: [] Advanced...

Format the text appearing in the column.



The only difference between the **Add Column**, **Insert Column**, and **Edit Column** dialog boxes is the name of the dialog box.

You can use the following settings to define the column to add:

- **Table Name** — This field is enabled for multi-table spreadsheet views and specifies the table on which the field to be displayed is located. This field is also enabled for single-table spreadsheets based on the **Activity** table.



For single-table spreadsheets based on the **Activity** table, the list contains filters that you can use to quickly locate a specific field within the Activity table.

- **Field Name** — Specifies the field to be displayed. This field can be either one of the standard Open Plan fields or a calculated field that has been added to a file.

In addition, you can simply type a calculated field that you create "on-the-fly" in this field.

- **Title** — Displays the text used to identify the field. While you can enter any text you wish in this field, the default provided by Open Plan is the field name that is stored in the data dictionary.
- **Wrap Text** — You can specify if Open Plan should wrap the data in the column cells and/or in the column headings. If you do not choose these options, Open Plan truncates the display of any data that does not fit within the column width.
- **Width** — If you click the **Best Fit** option, Open Plan automatically adjusts the column width so that either the column heading or the widest data item in the column can be displayed. You can also enter a **Specific** width in characters for the column.
- **Text** — You can format the text of the spreadsheet using the following options:
 - **Indent** — Selecting this option indents the data in the column to indicate the hierarchical level of the item.
 - **Overwrite Default Font Settings** — Selecting this option enables the following options that you can use to override the default settings
 - Italics
 - Bold
 - **Alignment** — This option allows you to specify how data in the column should be aligned:
 - <Default> — This setting is based on the data type: alphanumeric fields are left-aligned and numeric fields are right-aligned
 - Left
 - Center
 - Right
 - **Color** — This option allows you to override the default color for the text with a specific color that has been predefined for the application.
- **Formatting** — If the column contains numeric, duration, or date information, you can specify a display format for the data. For example, you can have Open Plan display durations using any of the following formats:
 - Minutes
 - Hours
 - Days

- Weeks
- Months



You can continue to enter duration information using any format regardless of the display format you have selected.

In the case of numeric values, you can specify the number of decimal places to display as well as the format.

The display of currency values can also be affected by the settings of the Control Panel in your copy of Windows.



For more information about how Open Plan handles the display of currency values, refer to the discussion of the **Formatting** setting in the online help system.

To add a column

1. Select a cell or column immediately to the left of the position for the new column.

You can select the column by clicking the column heading or by selecting a cell in the column.

2. Take one of the following actions:
 - On the **View** menu, point to **Spreadsheet**, and click **Add Column** on the submenu.
 - Right-click the column heading, and click **Add Column** on the context menu.
3. In the **Add Column** dialog box, enter the information for the new column.
4. When the information for the new column is complete, click **OK**.

Open Plan adds the column to right of the currently selected cell or column.

To insert a column

1. Select a cell or column immediately to the right of the position for the new column.

You can select the column by clicking the column heading or by selecting a cell in the column.

2. Take one of the following actions:
 - On the **View** menu, point to **Spreadsheet**, and click **Insert Column** on the submenu.
 - Right-click the column heading, and click **Insert Column** on the context menu.
3. In the **Insert Column** dialog box, enter the information for the new column.
4. When the information for the new column is complete, click **OK**.

Open Plan adds the column to left of the currently selected cell or column.

To delete a column

1. Select the column you want to delete.

You can select the column by clicking the column heading or by selecting a cell in the column.

2. Take one of the following actions:
 - On the **View** menu, point to **Spreadsheet**, and click **Remove Column** on the submenu.
 - Right-click the column heading, and click **Remove Column** on the context menu.

To edit a column

1. Select the column you want to edit.

You can select the column by clicking the column heading or by selecting a cell in the column.

2. Take one of the following actions:
 - On the **View** menu, point to **Spreadsheet**, and click **Edit Column** on the submenu.
 - Double-click the column heading.
 - Right-click the column heading, and click **Edit Column** on the context menu.
3. Enter the new information for the column, and click **OK**.

To reposition a column

1. Drag the column heading to the desired location.

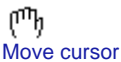
**To resize a column with a mouse**

1. Drag the column boundary to the desired width.

**Using the Fill Column Down Command**

The **Fill Column Down** command allows you to fill a spreadsheet column (or a selected range of cells in a column) with a single operation. To use this command, enter the value you want to apply to other cells in a spreadsheet column. Select a range of cells that includes the target cell as the topmost cell. Select **Fill Column Down** and Open Plan responds by filling all the selected cells with the value contained in the top cell of the range.



This command is available in both spreadsheet views and in the spreadsheet pane of a barchart view.

To use the Fill Column Down Command

1. In a spreadsheet view, select a range of cells within a single column.
2. Take one of the following actions:
 - Press **Ctrl+D**.

- On the **Edit** menu, click **Fill Column Down**.
3. When Open Plan asks for confirmation, click **OK**.

Open Plan responds by filling all the selected cells with the value contained in the topmost cell.



If you want to fill an entire column with the information in its first cell, right-click the column heading, and click **Fill Column Down** on the context menu.

Splitting the Spreadsheet View

Open Plan allows you to split the view into two panes in order to “freeze” the columns displayed in the left pane. No matter how far you scroll the right-hand pane horizontally, the information in the left-hand pane remains the same.

Splitter bar

Activity ID	Activity Desc.	Activity ID	Activity Desc.	Duration
1	Environmental Management System	1	Environmental Management System	572d
1.01	Requirements Development	1.01	Requirements Development	54d
1.01.01	Requirements Coordination & Planning	1.01.01	Requirements Coordination & Planning	30d
1.01.01.RES	Cleanup Resources	1.01.01.RES	Cleanup Resources	0
1.01.01.RES.EQUIP	Equipment	1.01.01.RES.EQUIP	Equipment	0
1.01.01.RES.EQUIP.CLEAN	Cleanup Equipment	1.01.01.RES.EQUIP.CLEAN	Cleanup Equipment	0
1.01.01.RES.EQUIP.CLEAN.1_09_02	Water Table Drillholes	1.01.01.RES.EQUIP.CLEAN.1_09_02	Water Table Drillholes	0
1.01.01.RES.EQUIP.TEST	Testing Equipment	1.01.01.RES.EQUIP.TEST	Testing Equipment	0
1.01.01.RES.EQUIP.TEST.1_02_01	Engineering Field Testing	1.01.01.RES.EQUIP.TEST.1_02_01	Engineering Field Testing	0
1.01.01.RES.EQUIP.TEST.1_03_06	Thermodynamic Data Research	1.01.01.RES.EQUIP.TEST.1_03_06	Thermodynamic Data Research	0



You can still horizontally scroll the left-hand pane if you wish to change the information that is displayed.

At the left edge of the horizontal scrollbar is the splitter control that you can use to drag the splitter bar to the desired position. The splitter bar marks the boundary between the two panes.



To split the view

1. Use one of the following procedures:
 - On the **View** menu, point to **Spreadsheet**, and click **Split View** on the submenu.
 - Double-click the splitter control located at the left edge of the horizontal scrollbar.
 - Point to the splitter control, and use the split view cursor that is displayed to drag the splitter bar to the desired location.



Split view cursor

Spreadsheet Display Options

You can set the various display options for a spreadsheet view with the **Options** tab of the **Spreadsheet Preferences** dialog box:

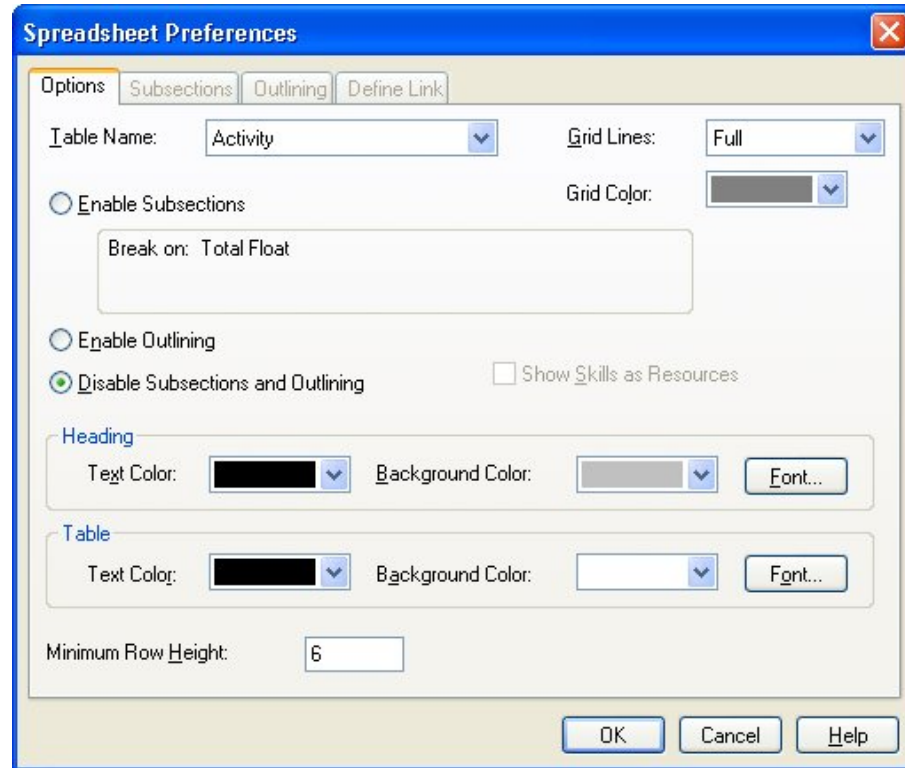

This tab controls how a spreadsheet is displayed by using the following settings:

- **Table Name** — Allows you to change the table upon which the spreadsheet is based.



For information on changing the spreadsheet table, refer to the “Support for All Tables” section later in this chapter.

- **Grid Lines** — Controls the display of grid lines on the spreadsheet. You can select one of the following settings from the list:
 - **Full** — Displays both horizontal and vertical grid lines
 - **Horizontal** — Displays horizontal grid lines only
 - **Vertical** — Displays vertical grid lines only
 - **None** — Suppresses the display of grid lines
- **Grid Color** — Controls the color of the grid lines that Open Plan displays on the spreadsheet. Clicking the **Grid Color** drop-down arrow displays a **Color** dialog box that you can use to select a color for the grid. The **Color** dialog box offers a choice of 48 standard colors and up to 16 additional custom colors.

You can define custom colors using an enhanced version of the **Color** dialog box accessed from the **General** tab of the **Options** dialog box.



For more information on defining custom colors, refer to Chapter 25, “System Defaults.”

- **Enable Subsections** — Subsections allow you to group related data for presentation in a single-table spreadsheet view based on the contents of an activity field.



For more information on subsections, refer to the “Subsections” section later in this chapter.

- **Enable Outlining** — With outlining, you can use the hierarchical information implicit in the activity ID to expand or collapse the display of detail information.



For more information on outlining, refer to the “Outlining” sections later in this chapter.

- **Disable Subsections and Outlining** — Turns off both subsections and outlining.
- **Show Skills as Resources** — Displays skills as resources on a resource spreadsheet.
- **Heading** — Allows you to define the text color, background color, and font of the heading section of a spreadsheet.
- **Table** — Allows you to define the text color, background color, and font of the table section of a spreadsheet.

To customize display options

1. On the **Tools** menu, click **Preferences**.

If you are in a barchart view, click **Spreadsheet Preferences** on the **Tools** menu.

You can also invoke this command by right-clicking an area of the spreadsheet and clicking **Preferences** on the context menu.

2. On the **Options** tab, enter the information for the display options.
3. To return to the view, click **OK**.

Support for All Tables

You can display any data table in a single-table spreadsheet view by using the **Table Name** option on the **Options** tab of the **Spreadsheet Preferences** dialog box:

Select a data table to display.

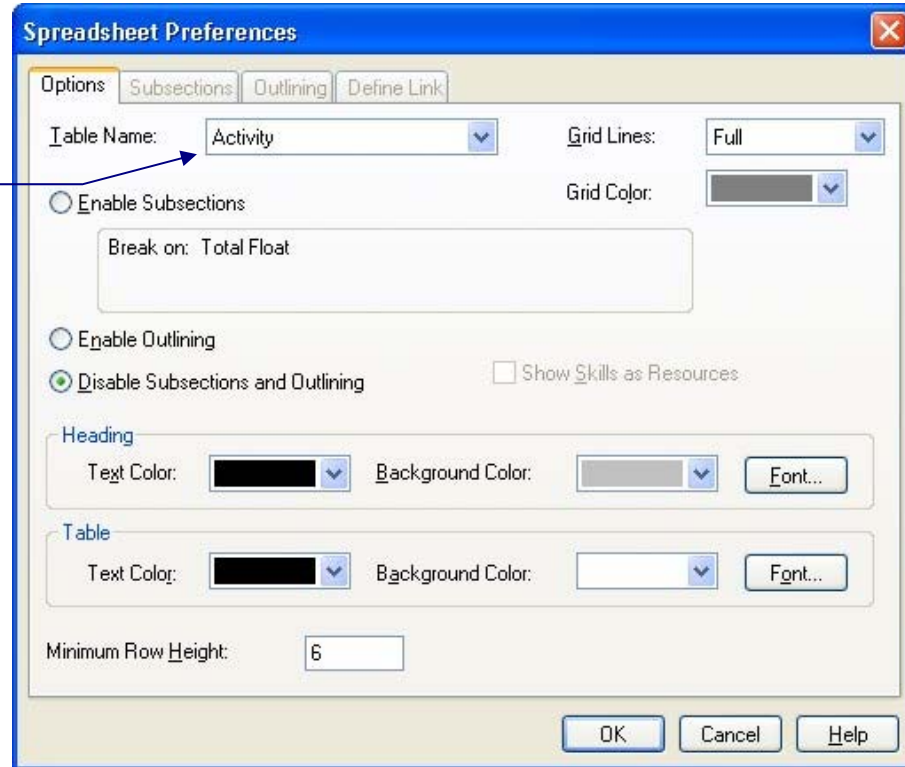

 The **Table Name** option is available only for single-table spreadsheet views.

This field contains a list from which you can select a data table that the spreadsheet should use. If you select a different table (for example, change from the Activity table to the Resource table), Open Plan replaces the selection of fields displayed in the spreadsheet with the default set of the new table.

When you change the data table, double-clicking the selection box for an activity on the spreadsheet displays the relevant **Details** dialog box.

 Because all code tables have the same structure, changing between code tables does not affect the columns that are displayed in the spreadsheet.

To change the spreadsheet table

1. Display a single-table spreadsheet view.
2. Take one of the following actions:
 - On the **Tools** menu, click **Preferences**.
 - Right-click an empty area of the spreadsheet, and click **Preferences** on the context menu.

3. From the **Table** list on the **Options** tab, select the data table to display.
4. Click **OK**.

Subsections

Subsections allow you to group related data for presentation in a single-table spreadsheet view based on the contents of an activity field:

Subsection header

Activity ID	Activity Desc.	Duration	Activity Type	Early Dates	Late Dates	Total Float	Calendar
+ Engineering and Design							
Manufacturing							
1.03.07	Design, Fabrication Prototype	46d	ASAP	26Aug03 28Oct03	01Sep03 03Nov03	4d	1
1.04.01	Environmental Package Design Construction	60d	ASAP	29Oct03 22Jan04	04Nov03 28Jan04	4d	1
1.04.02	Container Fabrication Development	32d	ASAP	23Jan04 08Mar04	29Jan04 12Mar04	4d	1
- OPERATIONS							
1.05.01	Site Investigation Integration	2d	ASAP	09Mar04 10Mar04	15Mar04 16Mar04	4d	1
1.10.02	Underground Services	24d	ASAP	07Jul04 09Aug04	03Aug04 03Sep04	19d	1
1.10.03	Rock Extraction	58d	ASAP	10Aug04 28Oct04	06Sep04 24Nov04	19d	1
1.10.04	Operations & Maintenance	8d	ASAP	10Aug04 19Aug04	15Nov04 24Nov04	69d	1
1.11.01	Sealing	16d	ASAP	23Nov04 14Dec04	25Nov04 16Dec04	2d	1
1.11.02	Management & Integration	14d	ASAP	15Dec04	17Dec04	2d	1

You can display summaries for subsections at either the top or the bottom of the group. The type of summarization Open Plan performs for a column depends on the data displayed in the column. For example, if the column displays a numeric value, then the summary represents the total of all the values for that subsection. On the other hand, a column displaying finish dates will summarize as the latest date in that group. Some columns (for example, activity IDs or descriptions) do not summarize at all.

You can control how calculated fields are summarized by Open Plan in subsections.





For more information on calculated fields, refer to Chapter 23, "Project Utilities."

You can also display a row showing grand totals for the entire project at the bottom of the view.

Open Plan allows you to specify the font, text color, and background color for subsection headings and summary lines. In addition, you can indicate a field to display for each heading. This allows you, for example, to base your subsections on a particular activity code and then display the description field for that code in the subsection heading. You also have the option of forcing a page break each time a new subsection appears in the view.

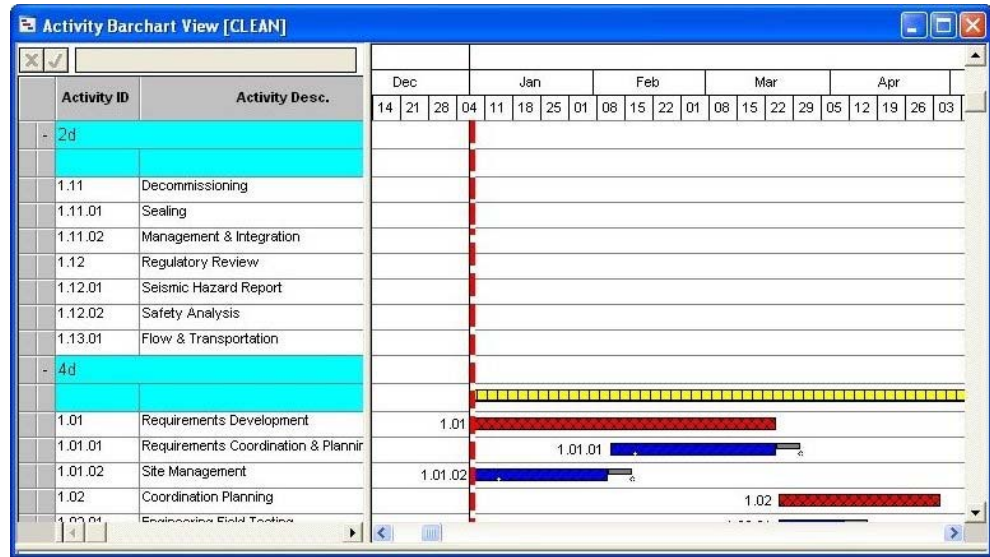
You can define subsections for the spreadsheet portion of a barchart view as well as for stand-alone spreadsheet views:



 If you use subsections for a view that has a sort order in effect, Open Plan sorts the rows within the defined subsections.

To enable subsections, use the **Options** tab of the **Spreadsheet Preferences** dialog box:

Click to enable subsections.

You can enable subsections using either the Professional or the Desktop edition of Open Plan. To define subsections, however, you must use Open Plan Professional.

To enable subsections

1. Open the appropriate spreadsheet or barchart view.
2. Take one of the following actions:
 - On the **Tools** menu, click **Preferences**. (In a barchart view, click **Spreadsheet Preferences**.)
 - Right-click the spreadsheet, and click **Preferences** on the context menu.
3. On the Options tab of the Spreadsheet Preferences dialog box, click Enable Subsections.

Defining Subsections

If you are using the Professional edition of Open Plan, you can control the subsections for a spreadsheet view. To set up subsections, you must first enable subsections on the **Options** tab of the **Spreadsheet Preferences** dialog box. You can then define the settings for the subsections by displaying the **Subsections** tab:

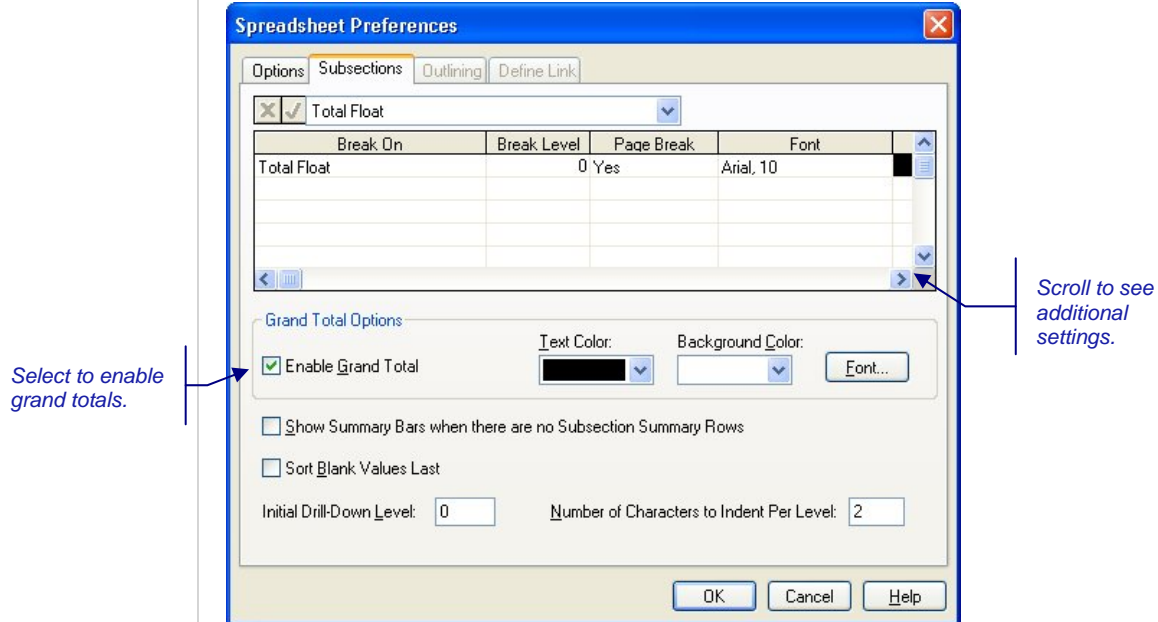

Subsections are defined using the **Break On** column on the **Spreadsheet Preferences Subsections** tab. Each additional row entered in the **Break On** column of the subsections grid indicates a further sublevel grouping.

Whenever you add a “break,” you can insert a heading row in the spreadsheet view to indicate a subsection. You can then choose a heading label for the row or just leave it blank.

The **Subsections** tab contains the following:

- **Grid** — Each line on the grid uses the following settings to control how Open Plan displays the information within a subsection. The grid on this tab contains the following fields:
 - **Break On** — This field defines the criteria by which members of the subsection are grouped. When this field is selected, Open Plan displays a list containing fields from the current table. If a hierarchical field is selected

from the list, you can further define the level in the hierarchy that determines the grouping. This field can be a user-defined calculated field.



You may subsection on data items from different tables with multi-table spreadsheet views. In this case, when you select the subsection data item, it appears in the form [TABLE]FIELD. In this case, FIELD refers to the actual field name that Open Plan uses internally (e.g., "ACT_ID" instead of "Activity ID").

- **Break Level** — The hierarchical level that triggers a subsection. This setting applies only if you selected a hierarchical field for the **Break On** setting. For example, a code field representing a work breakdown structure is a hierarchical field.
- **Page Break** — Set to **Yes** if you want Open Plan to begin a new printed page each time there is a different value at this row's subsection level.
- **Font** — The font used to display the subsection heading.
- **Text** — The text color used to display the subsection heading.
- **Background** — The background color used to display the subsection heading.
- **Heading** — This field controls the display of a heading line at the beginning of a subsection. If you select **Yes**, Open Plan enables the **Heading Field** column.



You must display headings for each subsection level if you want to be able to expand and collapse subsections in a view.

- **Summary** — This field controls the display of a summary line. The options for this field are:
 - **Bottom** – Displays the summary at the bottom of the subsection.
 - **Heading** – Displays the summary on the same row as the heading.
 - **Top** – Displays the summary at the top of the subsection.
 - **<None>** – Inhibits the display of a summary line.

If you are customizing the spreadsheet pane of a barchart view, you must display a subsection summary line to display a summarized bar in the barchart pane or you may enable the "Show Summary Bars when there are no Subsection Summary Rows" checkbox.

Summary information appears only for the following field types:

- **Numeric** – Display the total in a given section.
- **Date** – Displays the earliest date in the subsection.



If any of the start dates in a subsection are blank, the summary date will be blank as well.

- **Finish Date** – Displays the latest date in the subsection.
- **Heading Field** — Specify the field to appear in the subsection header for descriptive purposes. Open Plan offers a default heading field, usually the

same field on which subsections break. For hierarchical fields, however, the default heading is a combination of the ID and description fields appropriate to the level on which the subsectioning is based.



To set up a subsection heading that includes a descriptive label (for example, "Total Float ="), create a calculated field that contains the text string and assign it as the heading field. For information on calculated fields, refer to Chapter 23, "Project Utilities," in this guide and "Chapter 2, "Defining Calculated Fields," in the *Deltek Open Plan Developer's Guide*.

The bottom half of the **Subsections** tab contains the following settings:

- **Grand Total Options** — To generate a grand total summary row at the end of the report, select **Enable Grand Total**. You can also define a text color, background color, and font for the grand total.



The grand total of the view includes totals for all activities that are displayed in the current view. Activities that do not appear in the view due to a filter are not included in the grand total calculations.

- **Show Summary Bars when there are no Subsection Summary Rows** — Selecting this options will display summary bars in a barchart view when the Summary setting is not enabled.
- **Sort Blank Values Last** — Selecting this option causes a subsection containing blank values that would normally be sorted above non-blank values to be displayed below the non-blank values.
- **Initial Drill Down Level** — Controls the lowest level that is expanded on the spreadsheet when it is first opened. The default for this field is 0, which results in the top level being expanded.
- **Number of Characters to Indent per Level** — Controls the number of characters Open Plan should use when indenting a spreadsheet view that has heading rows defined. You can enter any value between 0 and 20.

To define subsections

1. Open the appropriate spreadsheet or barchart view.
2. Display the **Subsections** tab of the **Spreadsheet Preferences** dialog box.
3. Enter the information for the subsections, and click **OK** to return to the view.

Outlining

Outlining is a feature available in spreadsheet views, including the spreadsheet portion of the barchart view. With outlining, you can use the hierarchical information implicit in the activity ID to expand or collapse the display of detail information:

Click to collapse or expand this row

Activity ID	Activity Desc.	Duration	Activity Type	Early Dates	Late Dates	Total Float	Calendar
1	Environmental Management System	572d	Subproject	02 Jan03 15 Mar05	08 Jan03 15 Mar05	0	1
+ 1.01	Requirements Development	54d	Subproject	02 Jan03 18 Mar03	08 Jan03 24 Mar03	4d	1
- 1.02	Coordination Planning	29d	Subproject	19 Mar03 28 Apr03	25 Mar03 02 May03	4d	1
+ 1.03	Environmental Package System	131d	Subproject	29 Apr03 28 Oct03	05 May03 03 Nov03	4d	1
1.03.01	Chemical & Mineralogical Survey	3d	ASAP	29 Apr03 01 May03	05 May03 07 May03	4d	1
1.03.02	Geochemical Properties	50d	ASAP	02 May03 10 Jul03	08 May03 16 Jul03	4d	1
1.03.03	Spent Fuel Modeling	50d	ASAP	02 May03 10 Jul03	03 Jul03 10 Sep03	44d	1
1.03.04	Spent Fuel Tests	38d	ASAP	11 Jul03 02 Sep03	11 Sep03 03 Nov03	44d	1
1.03.05	Research Integration Model	10d	ASAP	11 Jul03 24 Jul03	17 Jul03 30 Jul03	4d	1
1.03.06	Thermodynamic Data Research	22d	ASAP	25 Jul03 25 Aug03	31 Jul03 29 Aug03	4d	1
1.03.07	Design, Fabrication Prototype	46d	ASAP	26 Aug03	01 Sep03	4d	1



For information about using outlining to expand and collapse subprojects, refer to Chapter 6, "Activity Information."

With the outlining feature, you can display higher-level elements using a different font and background color to distinguish them from detail rows. You can also indicate the default level for collapsing information.



If you use outlining for a view with a filter in effect, the display of child items is determined by the status of the parent. If you use outlining for a view that has a sort order in effect, Open Plan sorts the rows within the defined outlining structure.

To enable outlining for a spreadsheet view, use the **Options** tab of the **Spreadsheet Preferences** dialog box:

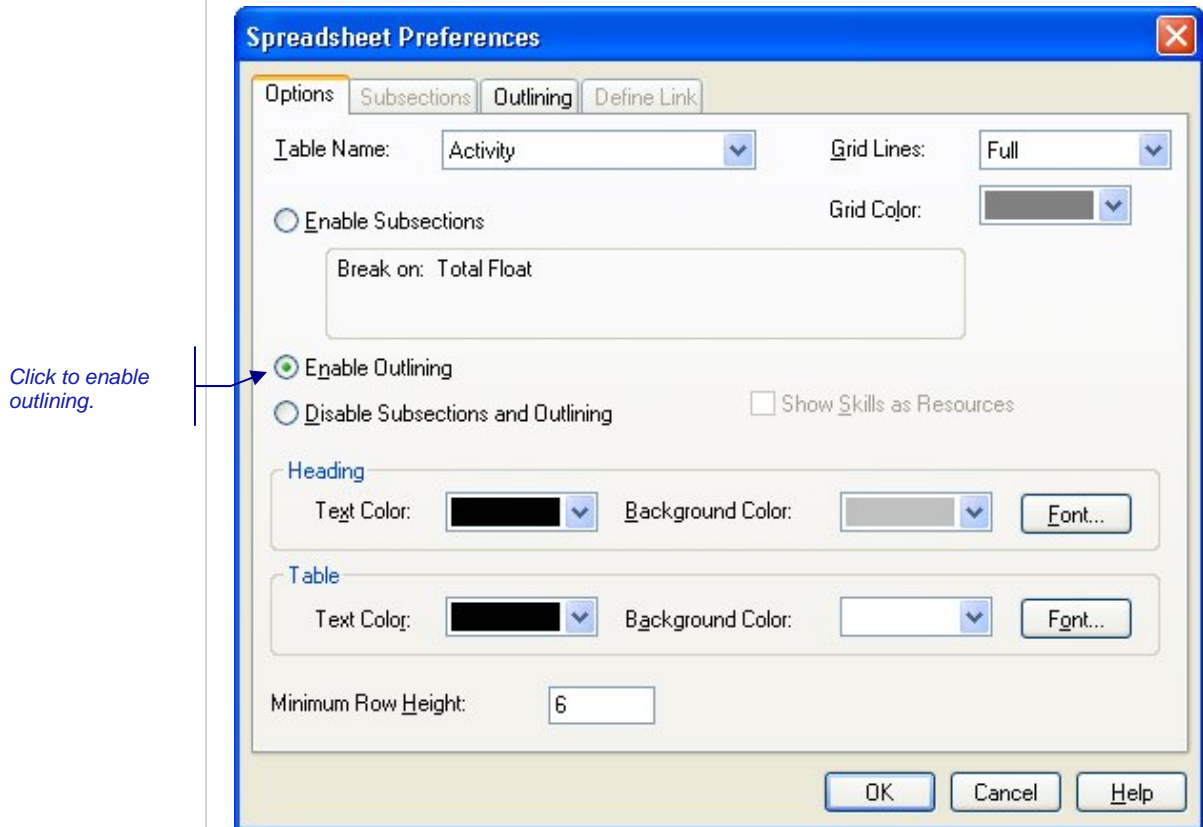

You can enable outlining using either the Professional or the Desktop edition of Open Plan. To define outlining, however, you must use Open Plan Professional.

To enable outlining

1. Open the appropriate spreadsheet or barchart view.
2. Take one of the following actions:
 - On the **Tools** menu, click **Preferences**. (In a barchart view, click **Spreadsheet Preferences**.)
 - Right-click a row or a column heading in the spreadsheet, and click **Preferences** on the context menu.
3. On the Options tab of the Spreadsheet Preferences dialog box, click Enable Outlining.

Defining Outlining

If you are using the Professional edition of Open Plan, you can control the outlining feature for a spreadsheet view. To define outlining, you must first enable the feature by clicking **Enable Outlining** on the **Options** tab of the **Spreadsheet Preferences** dialog box. You can then define the settings for outlining by displaying the **Outlining** tab:

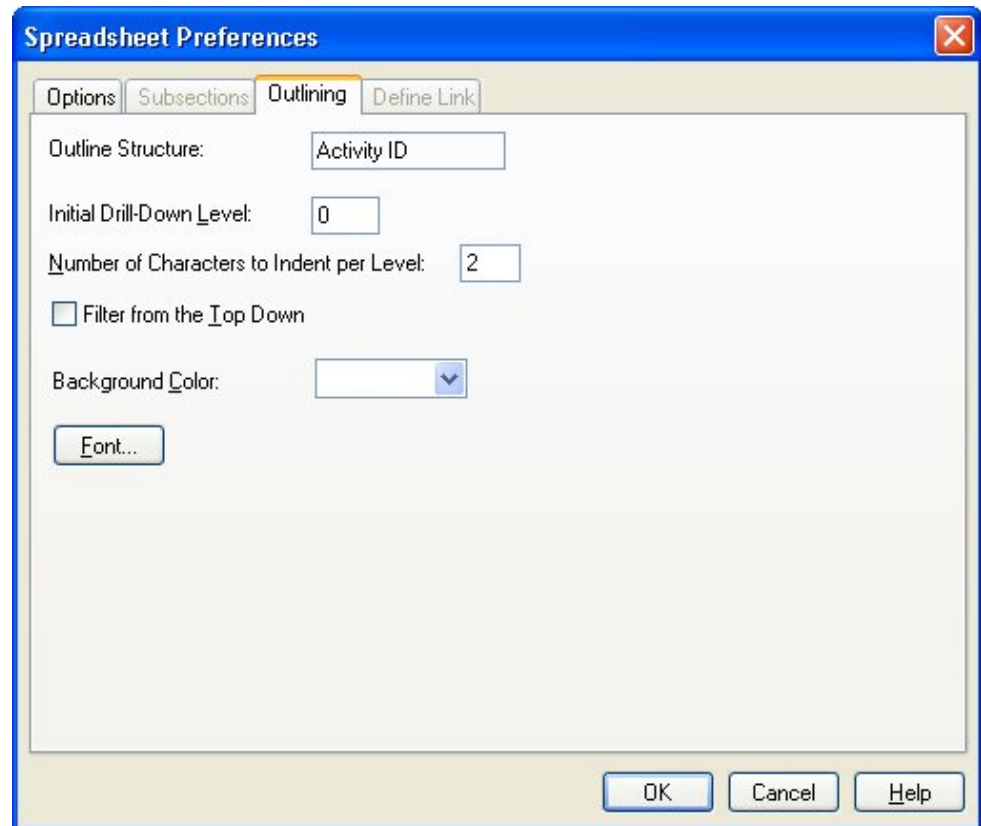

Use the following settings to define outlining for a view:

- **Initial Drill Down Level** — Controls the lowest level that is expanded on the spreadsheet. You can enter any value for this field between 0 and 20. The default is 0. This means that the entire structure is collapsed.
- **Number of Characters to Indent per Level** — Controls the number of characters Open Plan should use when indenting a spreadsheet view that has the outlining option enabled. You can enter any value between 0 and 20.
- **Filter from the Top Down** — When using outlining in a spreadsheet or barchart, this option controls how Open Plan applies a filter:
 - If this option is selected, Open Plan applies the filter to a parent activity before applying it to its children. When the filter is applied top down, an activity is displayed only if it and all of its descendents match the filter. This may cause some activities not to be displayed even though they match the filter. For example, assume that Activity A matches the filter, but that its child Activity A.1 does not. With this setting, neither Activity A nor Activity A.1 will be displayed.
 - If this option is cleared, Open Plan applies the filter bottom up. This means that Open Plan applies the filter to a child activity before applying it to its parent. This is the default setting. When the filter is applied bottom up, an activity is displayed if it or any of its descendents match the filter. This may cause some activities to be displayed even though they, themselves, do not match the filter. For example, assume that Activity A does not match the filter, but that its child Activity A.1 does. With this setting, both Activity A.1 and its parent, Activity A will be displayed.

- **Background Color** — Controls the background color Open Plan displays for the outline rows. Clicking the down arrow for this field displays a **Color** dialog box that you can use to select a color for that feature. The **Color** dialog box offers a choice of 48 standard colors and up to 16 additional custom colors.



You can define custom colors using an enhanced version of the **Color** dialog box accessed from the **General** tab of the **Options** dialog box.

- **Font** — Click the **Font** button to display a dialog box where you can change all the font attributes for the text Open Plan displays for the outline rows.



Open Plan always sorts within the outline and calculates summary information for outlining from the entire project, regardless of any filters in effect.

To define outlining

1. Open the appropriate spreadsheet or barchart view.
2. Display the **Outlining** tab of the **Spreadsheet Preferences** dialog box.
3. Enter the information for the outlining feature, and click **OK** to return to the view.

Linking

Although it is possible to display individual fields from different data tables using calculated fields, Open Plan offers a more general linking capability in multi-table spreadsheet views. In multi-table spreadsheet views, you can display any field from linked tables just as though the field resided on the primary data table for the view. This allows you to produce sophisticated reports showing information from a number of different data tables.

Open Plan provides a number of standard multi-table spreadsheet views, including a resource/activity spreadsheet that displays information from the resource description table (the primary data table for the view), the assignment table, and the activity table:

	Resource ID	Res. Desc.	Activity ID	Activity Desc.	Duration	Remaining Dur.	Early Start
-	RES	Cleanup Resources			0	0	
-	RES.EQUIP	Equipment			0	0	
-	RES.EQUIP.C	Cleanup Equipment			0	0	
			1.09.02	Water Table Drill	26d	26d	26Oct04
-	RES.EQUIP.T	Testing Equipment			0	0	
			1.02.01	Engineering Field	13d	13d	19Mar03
			1.03.06	Thermodynamic [22d	22d	25Jul03
			1.06.02	Laboratory Thern	6d	6d	05Jun04
-	RES.LAB	Labor			0	0	
+	RES.LAB.EN	Engineers			0	0	
+	RES.LAB.GE	Geologists			0	0	
+	RES.LAB.TE	Technicians			0	0	

In the example illustrated above, notice that there are many assignments for each resource — in other words, there is a one-to-many relationship between each resource (the primary record) and its assignments (the secondary records). Just as you can expand and collapse records in a spreadsheet view using outlining, multi-table spreadsheet views allow you to expand and collapse the display of information based on one-to-many relationships. To expand or collapse the display of secondary records in a multi-table spreadsheet view, use the outlining button (displayed to the left of the row) or the **Collapse**, **Expand**, and **Expand All** commands.



Multi-table spreadsheet views can combine outlining on an activity or resource ID with the display of one-to-many secondary records from linked data tables.

Defining Links

If you are using the Professional edition of Open Plan, you can define the links for many multi-table spreadsheet views. By customizing the linking in a multi-table spreadsheet view, you can display fields from any linked data table. To define links in a multi-table spreadsheet view, display the **Define Links** tab in the **Spreadsheet Preferences** dialog box:

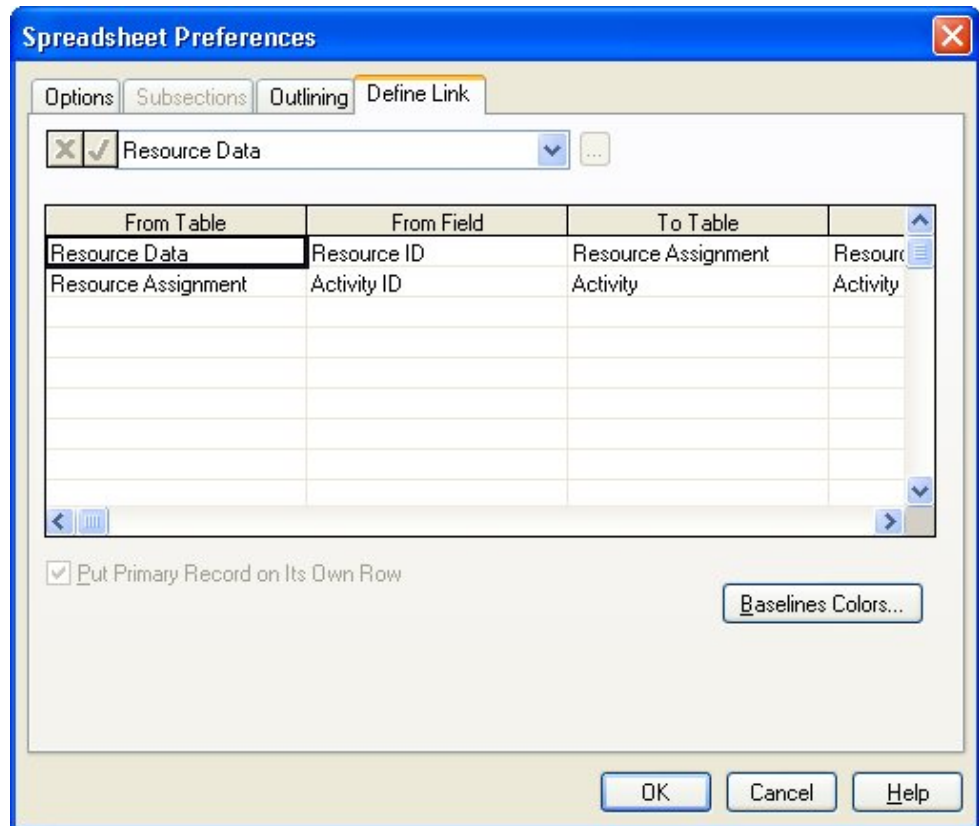

Use this dialog box to define the tables and fields comprising the link. For example, to link to the **Assignment** table from the **Resource Description** table, you might use the **Res. ID** field, which appears on both tables. This type of one-to-many link would allow you to display the activity IDs for each assignment stored for a resource. To display more information about these activities (for example, their descriptions), you could then link from the **Assignment** table to the **Activity** table using the activity **ID** field.



For a complete listing of data tables and fields in Open Plan, refer to Chapter 18, "Open Plan Table Migration" in the *Deltek Open Plan Developer's Guide*.

Notice that Open Plan does not allow recursive linking — that is, linking a file back to itself. Thus, for example, you cannot create a view that shows both predecessors and successors for activities by linking the **Activity** table to the **Relationship** table and then linking the **Relationship** table back to the **Activity** table. Instead, you must define two links between the **Activity** table and the **Relationship** table as follows:

From Table	From Field	To Table	To Field
Activity	Activity ID	Relationship	Pred ID
Activity	Activity ID	Relationship	Succ ID

Open Plan limits the list choices for linking tables and fields to only those that are based on the **From Table**.

For example, if the resource description table is linked to both the assignment and usage tables, data from the assignment and usage records will be displayed on the same line. This is true even if no relationship exists between the data from these two tables except through the single resource description record.

You can also use this **Define Links** tab to indicate if the primary record should appear on a row by itself in cases of one-to-many links. If you do not select the **Put Primary Record on Its Own Row** option, Open Plan displays the first linked record on the same row as the primary record.

Clicking **Baselines Colors** displays a dialog box that allows you to assign a different color for up to three baselines.



For more information on multiple baselines, refer to Chapter 16, "Status Information."

To define links

1. On the **Tools** menu, click **Preferences**.

If you are in a barchart view, click **Spreadsheet Preferences** on the **Tools** menu.

You can also invoke this command by right-clicking a column heading and clicking **Preferences** on the context menu.

2. On the **Define Links** tab, enter the tables and fields that define the links, and click **OK** to return to the view.

Modifying Hierarchical IDs Using Indent and Outdent

Open Plan allows you to quickly modify hierarchical IDs for activity, resource assignment, and code assignment spreadsheets by using the **Indent** and **Outdent** commands.

After displaying the appropriate spreadsheet, you simply select the target ID and issue either the **Indent** or **Outdent** command. Depending on the command, Open Plan responds with one of the following actions:

- **Indent** — The target ID is made into a child of the previous ID and that previous ID is made into a subproject if it is not already one.

For example, assume you have a project with the following hierarchy:

```
10
20
30
40
50
```

Indenting ID 20 instructs Open Plan to make it a child of ID 10 and to make ID 10 a subproject. Therefore, the following hierarchy results:

```
10
    10.20
30
40
50
```

- **Outdent** — The target ID is promoted to the level of its parent and assigned the first available ID in the hierarchy.

For example, assume you have a project with the following hierarchy:

```
10
    10.1
30
40
50
```

If ID 10.1 were to be outdented, Open Plan would promote it to the same level as ID 10 and assign it the first available ID according to the rules of automatic numbering.



For more information on automatic numbering, refer to the next section, "Automatic Numbering within a Spreadsheet."

Automatic Numbering within a Spreadsheet

Activity IDs and resource IDs can be generated automatically from within a spreadsheet view. If you leave the ID field blank on the appropriate **Details** dialog box when creating a new activity or resource, Open Plan generates an ID for the new item automatically according to the following rules:

- If the previous ID at a given level is all alphabetic, the program increments alphabetically.
- If the previous ID at a given level is a mixture of alphabetic and numeric characters, the numeric part is incremented numerically.
- If there is no previous ID, the program uses a numeric ID. Therefore, the first ID in the file is numbered "1."

Open Plan attempts to find a pattern in the ID numbering scheme for IDs that are incremented numerically by looking at the last two IDs in the hierarchy. If a pattern can be established, Open Plan uses the pattern when automatically creating a new ID.

For example, assume that your project has the following hierarchy:

A11
A12
A13
A14
A15
A20

Open Plan looks at the last two IDs in the hierarchy and determines that there is an difference of 5 between the two. Therefore, if you use automatic numbering to create the next ID, Open Plan creates ID A25.

On the other hand, if there is only one ID in the hierarchy and you have Open Plan create the other IDs, it uses the ID's value as the incremental pattern.

For example, if you enter 12 for the first ID in the hierarchy and then have Open Plan create the remaining IDs, it increments the IDs by 12 resulting in the following hierarchy:

12
24
36
48
60



For information on using automatic numbering when creating new resources in a resource view, refer to Chapter 7, "Resource Definitions." For information on using automatic numbering when creating new codes in a code view, refer to Chapter 11, "Project Codes."

21

Histogram Views

➤ Overview	495
➤ Working with Resource Histograms.....	496
➤ Displaying Resource Information	499
➤ Displaying Earned Value Information.....	503
➤ Customizing Resource Histogram Views.....	506
➤ Working with Risk Histograms	511
➤ Customizing Risk Histogram Views	513

Overview

Open Plan offers two types of histogram views: resource histograms and risk histograms. Both types of views allow you to display time-scaled data using a graphical format, a tabular format, or a combination of the two.

Resource histograms are familiar reporting tools in most project management systems since they can display resource and cost data in an easy-to-understand graphical form. Resource histogram views are especially useful for modeling project resources since they allow you to compare resource assignments to availabilities as well as allow you to view the overall usage of a resource (or a group of resources) over the time span of the project.

Risk histograms, on the other hand, display the results of risk analysis for designated key activity in a project. Risk histograms allow project planners to see at a glance how Open Plan scheduled an activity over the course of many trial simulations.

In Open Plan, you can display a resource histogram as a stand-alone view or as part of a barchart view. In either case, the features of the resource histogram are identical, and you can perform any operation in a similar manner in either view. By contrast, risk histograms are available only as stand-alone views.

This chapter starts with a general discussion of resource histogram views in Open Plan, followed by a description of the types of resource and earned value information that can appear in a histogram view. Next is a description of how to customize a resource histogram.

The chapter concludes with a discussion of risk histograms, followed by information on how to select an activity to view in a risk histogram and how to customize the view.

Working with Resource Histograms

To display a resource histogram in Open Plan, the following conditions must be met:

- You have assigned a resource file to a project.
- The project has at least one activity with a resource assignment.
- You have selected a resource to display. (Use the **Select Resource** command from the **View** menu to indicate your selection.)



If you are only interested in showing resource or cost information based on early or late dates, you do not have to perform resource scheduling to display a resource histogram.

Each bar in the histogram represents a value corresponding to the smallest time unit displayed on the date scale. For example, if you define a date scale with the most detailed axis showing months, you can display bars that show how many units of the selected resource are required on a monthly basis:

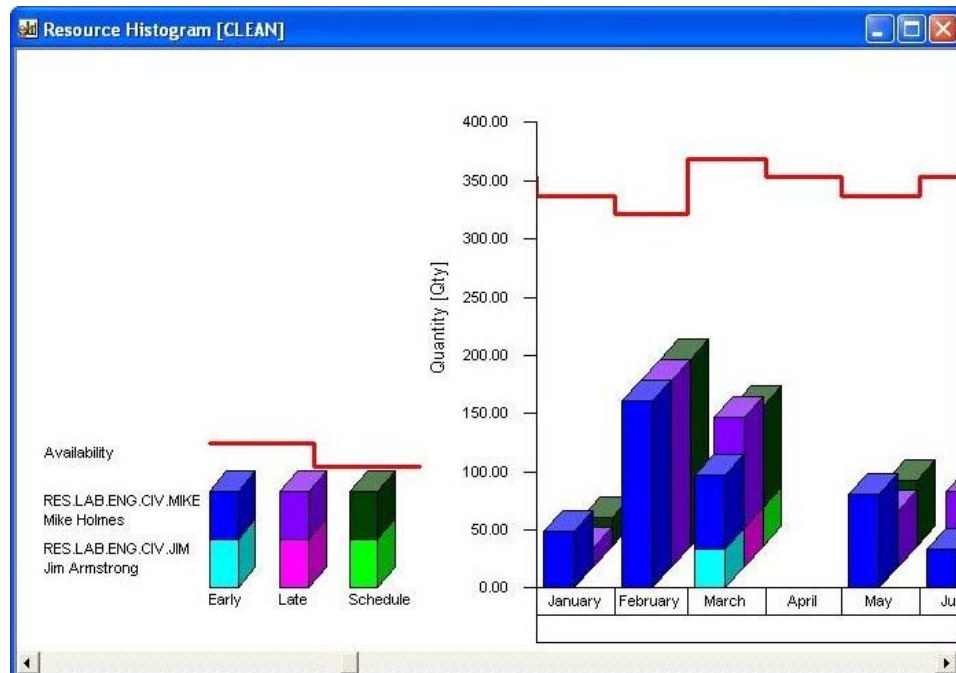

If you are displaying a resource histogram as part of a barchart view, the date scale for the barchart pane controls the display of the histogram. If you are displaying the resource histogram as a stand-alone view, the date scale typically starts at the earliest instance of relevant project data. For example, if you are not displaying actual cost information, the histogram starts at Time Now since this is the earliest date that time analysis or resource scheduling can schedule an activity.

When you view a resource histogram that shows bars or S-curves, notice the legend to the left of the date scale. This legend tells you the type of information represented by the bars and S-curves.

If you prefer to see the precise values being represented in the view, you can configure a resource histogram to display information in a tabular format below the bars:

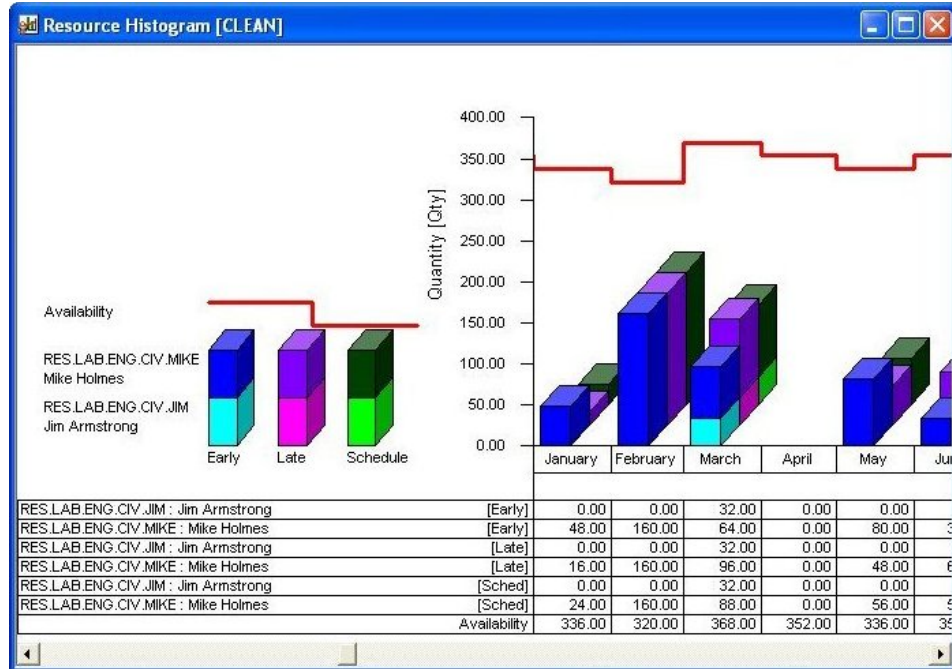

It is also possible to display just the tabular portion of the view.

As in the case of histogram bars, the aggregation of tabular data corresponds to the smallest unit displayed on the date scale.

In addition to displaying information aggregated on a period-by-period basis, you can display cumulative S-curves in a resource histogram view:

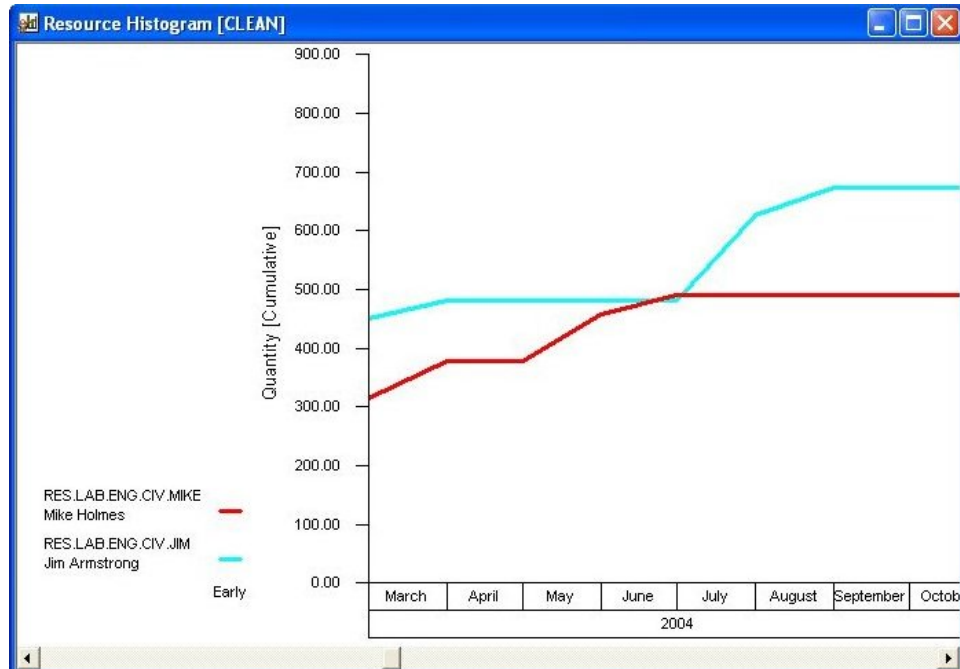

This feature can be combined with the display of histogram bars:

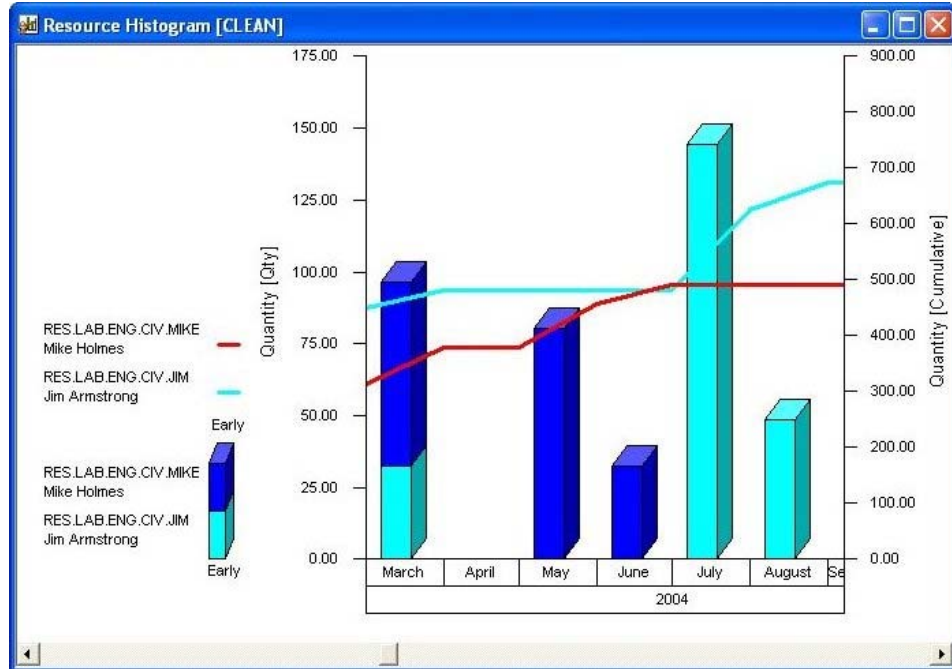

Views that combine both histogram bars and S-curves, the vertical axis for the histogram bars appears on the left, while the vertical axis for the S-curve appears on the right.

Displaying Resource Information

Resource histogram views allow you to display the following types of resource information in a graphical format:

- Resource availabilities
- Resource assignments based on the early dates calculated by time analysis
- Resource assignments based on the late dates calculated by time analysis
- Resource assignments based on the scheduled dates calculated by resource scheduling (these assignments can show the effects of splitting, stretching, and reprofiling activities)
- Baseline resource assignments using the dates (early, late, or scheduled) selected at the time you created the baseline currently attached to the project
- Actual resource usage based on resource progress information

You can use a resource histogram view to display any of these items individually, or you can display more than one at the same time.

The options that define how resource information appears in a view are found on the **Resources** tab of the **Histogram Preferences** dialog box:

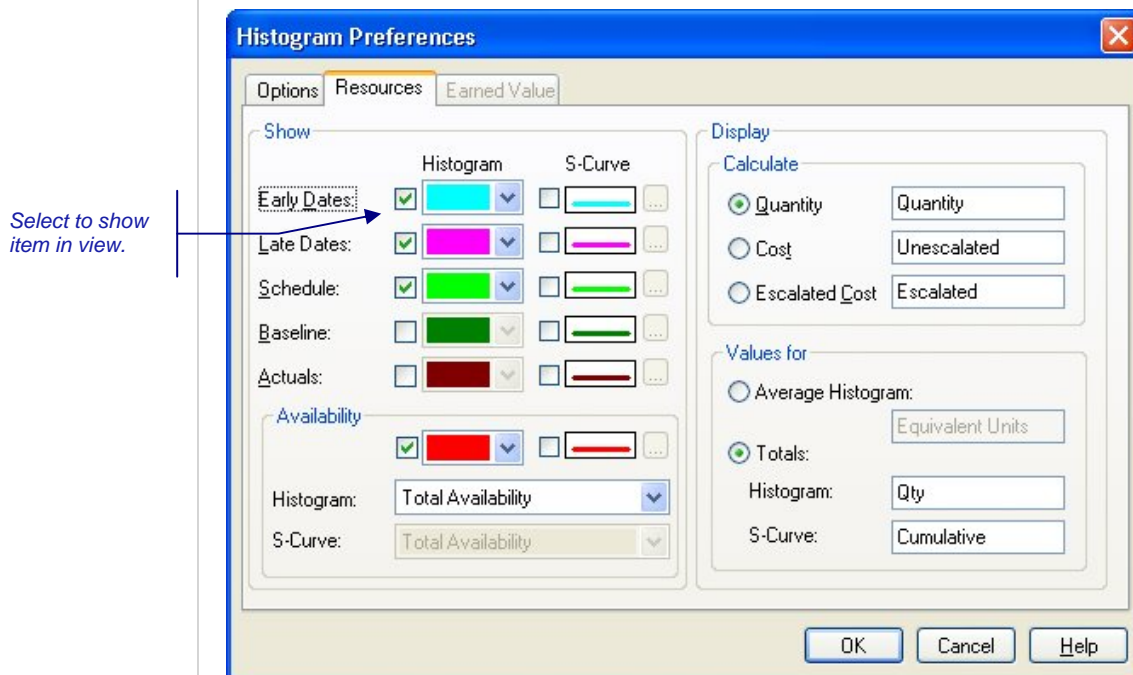

Use the following settings to control the appearance of resource information:

- **Show** — You can indicate one or more sets of resource data to appear in the view as either histogram bars or S-curves. You can also indicate the color of the bar by clicking the drop-down arrow to display a **Color** dialog box from which you can choose a color. For S-curves, clicking the **ellipsis** button displays the **S-Curve Line Selection** dialog box that you can use to indicate the line style and color to use for the line.



For early dates, late dates, scheduled dates, baseline dates, and actuals, the defined color indicates the color of the first selected resource when stacked. Subsequent stacked resources are assigned a color automatically by Open Plan.

- **Availability** —You can select from the following options to choose the type of availability data that Open Plan should show in both a histogram bar and an S-curve:
 - **Total Availability** — Displays the total availability of the resource. The histogram does not identify quantities that are reserved for another project or used by a project with a higher priority.
 - **Unreserved Availability** — Displays the availability that is not reserved for another project.
 - **Unused Availability** — Displays the availability that is not used by a project with a higher priority or reserved for another project.
 - **Total & Reserved** — Displays both the total availability and the availability that is reserved for another project.
 - **Total & Reserved or Used** — Displays both the total availability and the availability that is either reserved for another project or used by a project with a higher priority.
 - **Total, Reserved and Used** — Displays the total availability, the availability that is reserved for another project, and the availability that is used by a project with a higher priority.
 - **Unreserved and Used** — Displays both the availability that is not reserved for another project and the availability that is used by a project with a higher priority.

If the option selected includes the total, this is shown with a solid line. Otherwise, the solid line will represent the net availability of reserved availability, or the net availability of reserved and used availability.

If the option selected includes more than one of the three possibilities, these will be shown as progressively lighter filled areas below the solid line.

The following histogram has the option **Total, Reserved and Used** selected and shows the gradation of the availability line:

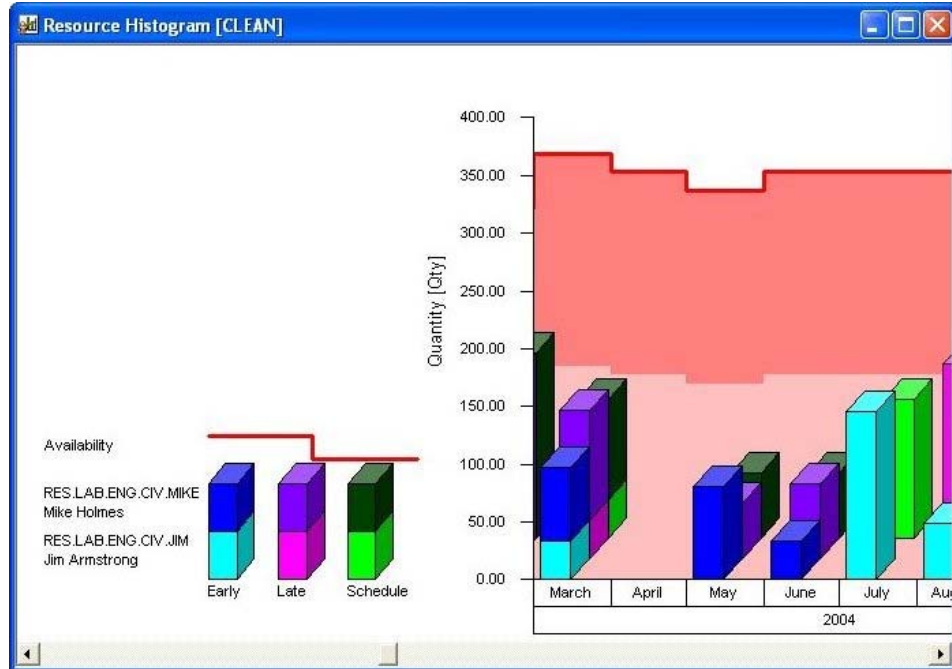

By comparing resource assignments and usage with the availability information, you can easily see where each resource is over- or under-utilized.

- **Calculate** — You can have Open Plan display resource information in terms of either resource units, base unit costs, or escalated costs. You can also specify the label displayed on the vertical axis for the selected value.



The option to show escalated costs does not affect the display of actuals.

- **Values for** — You can control which values appear in the view with one of the following options:
 - **Average Histogram** — Resource values appear as bars representing an average value per the default duration unit used by the project. Open Plan calculates this average over the smallest time unit displayed on the date scale and uses the default project calendar to determine valid working periods. (If you have not assigned a calendar to the project, Open Plan assumes a 5-day, 40-hour work week with no holidays.) This option does not apply to S-curves.
 - **Totals** — In Open Plan, histogram bars can display total values. When this option is selected, each bar represents a total value for the period defined by the date unit. S-curves represent cumulative total values.

Text boxes allow you to enter labels for both histogram bars and S-curves.



To create a view that shows the equivalent headcounts for resource availabilities and assignments based on person-days, display average resource values.

To define the display of resource information

1. Display the **Histogram Preferences** dialog box by taking one of the following actions:
 - On the **Tools** menu, click **Histogram Preferences** (in a barchart view) or **Preferences** (in a histogram view).
 - Right-click anywhere in the view, and click **Preferences** on the context menu.
2. On the **Options** tab, click the **Resources** setting for the **Display** option.
3. Click the **Resources** tab.
4. Enter the information, and click **OK** to return to the view.

Displaying Earned Value Information

As an alternative to resource information, you can display the following types of earned value information in a resource histogram view:

- **Forecast** — Open Plan determines the forecast cost (Estimate At Complete or EAC) of a resource by adding any actual costs prior to Time Now to any planned costs subsequent to Time Now. If you choose to display forecast costs, you can base planned costs on early, late, or scheduled dates.
- **Budgeted Cost of Work Scheduled (BCWS)** — BCWS is derived from the planned resource budget stored in the current baseline for the project. This budget may be based on early, late, or scheduled dates depending on the dates used to create the baseline.
- **Actual Cost of Work Performed (ACWP)** — ACWP is based on the actual costs recorded for the resource.
- **Budgeted Cost of Work Performed (BCWP)** — To calculate BCWP, Open Plan applies the value from the physical completion of the resource assignment to the corresponding portion of the planned resource budget (as defined in the current project baseline). For example, if you indicate that resource assignment has a physical complete value of 50%, Open Plan calculates BCWP for an assigned resource by determining how much of its planned budget (BCWS) corresponds to the first half of the activity duration.



Note that earned value information can be displayed in terms of either resource units or resource costs.

You can use a resource histogram view to display any of these items individually, or you can display more than one at the same time.

The options that define how earned value information appears in a histogram view are found on the **Earned Value** tab of the **Histogram Preferences** dialog box:

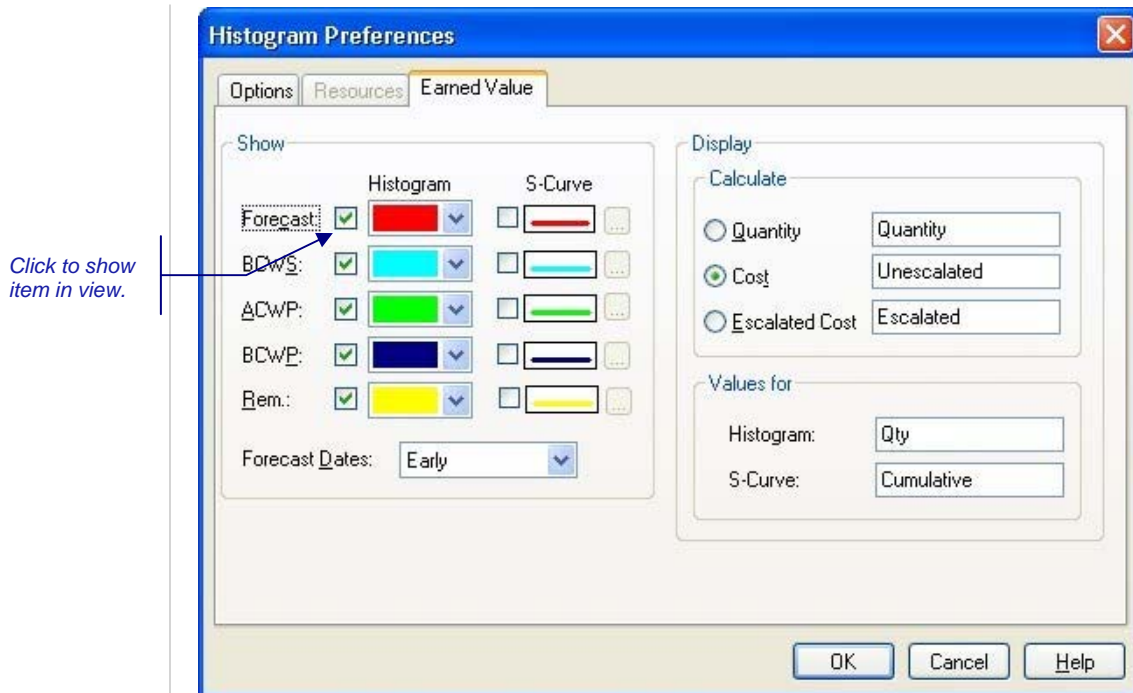

Use the following settings to control the appearance of earned value information:

- **Show** — You can indicate one or more sets of earned value data to appear in the view. You can also indicate the color of the bar or line for each item. If you are displaying forecast costs, you can indicate which set of forecast dates to use as the basis of the forecast.



The defined color indicates the color of the first selected resource. Subsequent resources are assigned a color automatically by Open Plan.

- **Calculate** — You can have Open Plan display earned value information in terms of either resource units, base unit costs, or escalated costs. You can also specify the label displayed on the vertical axis for the selected value.



The option to show escalated costs does not affect the actuals portion of forecast costs or the display of ACWP.

- **Values for** — You can also specify identification labels for both histograms and S-curves.

To define the display of earned value information

1. Display the **Histogram Preferences** dialog box by taking one of the following actions:
 - On the **Tools** menu, click **Histogram Preferences** (in a barchart view) or **Preferences** (in a histogram view).
 - Right-click anywhere in the view, and click **Preferences** on the context menu.
2. On the **Options** tab of the **Histogram Preferences** dialog box, click the **Earned Value** setting for the **Display** option.

3. Click the **Earned Value** tab.
4. Enter the information, and click **OK** to return to the view.

Customizing Resource Histogram Views

Three operations allow you to customize resource histogram views in Open Plan:

- Selecting resources
- Defining histogram display options
- Customizing the date scale

Selecting Resources

Before you can display data in a resource histogram, you must select the resource(s) to include in the view. When you click **Select Resource** on the **View** menu, Open Plan displays the **Resource Selection** dialog box:

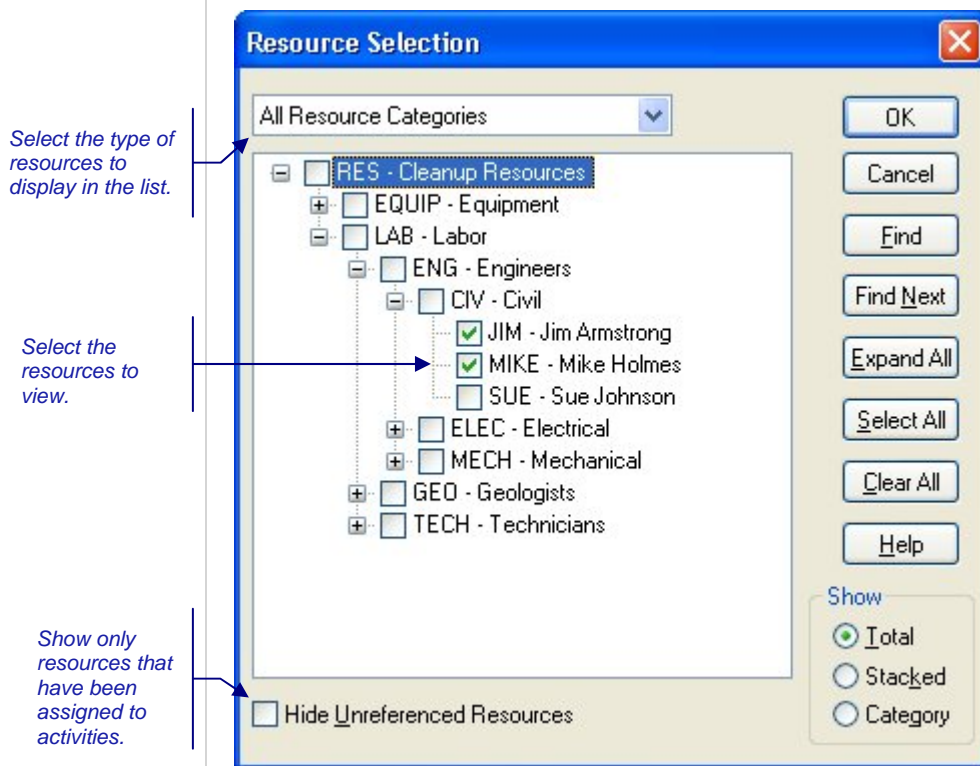

Select the type of resources to display in the list.

Select the resources to view.

Show only resources that have been assigned to activities.

The list field at the top of the dialog box allows you can to filter the display of resources by category:

- All Resource Categories
- Labor
- Material
- Other Direct Costs
- Subcontract



A resource's category is defined on the **General tab** of the **Resource Details** dialog box.

The **Expand All** button will expand the entire hierarchy for viewing.

To display a resource from the list, simply select the check box next to the resource name. To select all the resources, click the **Select All** button.

You can also choose to display resource pools in the histogram. Keep in mind, however, that all availabilities, requirements, and usage displayed for a pool include both the pool and a roll-up of the child resources belonging to the pool. Clearing the **Hide Unreferenced Resources** setting displays the entire resource use file hierarchy, which makes the resource pools available for selection.



When selecting resources to display, be sure that all selected resources use the same time unit. For example, you should not mix resources measured in person-hours and resources measured in person-days or person-weeks in the same bar.

The **Show** options determine how Open Plan displays bars or curves representing more than one resource. There are three choices:

- **Total** — This option displays the resource bars or curves for multiple resources as a total quantity. You cannot discern the amount of resource requirement or usage within a time frame for any specific resource.
- **Stacked** — This option displays the resources bars for multiple resources in a stacked format. Each selected resource is displayed in a separate color. In the case of cumulative values, Open Plan displays separate S-curves for each resource.
- **Category** — This option displays the resource bars for each resource category. In the case of cumulative values, Open Plan displays separate S-curves for each resource category.



If you select both a pool and any other pool or individual resource, the histogram displays each pool as a total histogram bar or S-curve.

To select resources

1. Take one of the following actions:
 - On the **View** menu, click **Select Resource**.
 - Right-click anywhere in the view, and click **Select Resource** on the context menu.
2. Select one or more resources from the list displayed in the dialog box. To select all the resources, click **Select All**.
3. Indicate if the bars and curves should be total, stacked, or category.
4. When the information is complete, click **OK** to return to the view.

If you have applied a filter to the view, a resource histogram represents only those activities that satisfy the filter.



For information about filters, refer to Chapter 17, "Views and Reports."

Resource Histogram Display Options

To define the appearance of bars in a resource histogram view, click **Histogram Preferences** on the **Tools** menu or right-click within the histogram view and click **Preferences** on the context menu to display the **Options** tab of the **Histogram Preferences** dialog box:

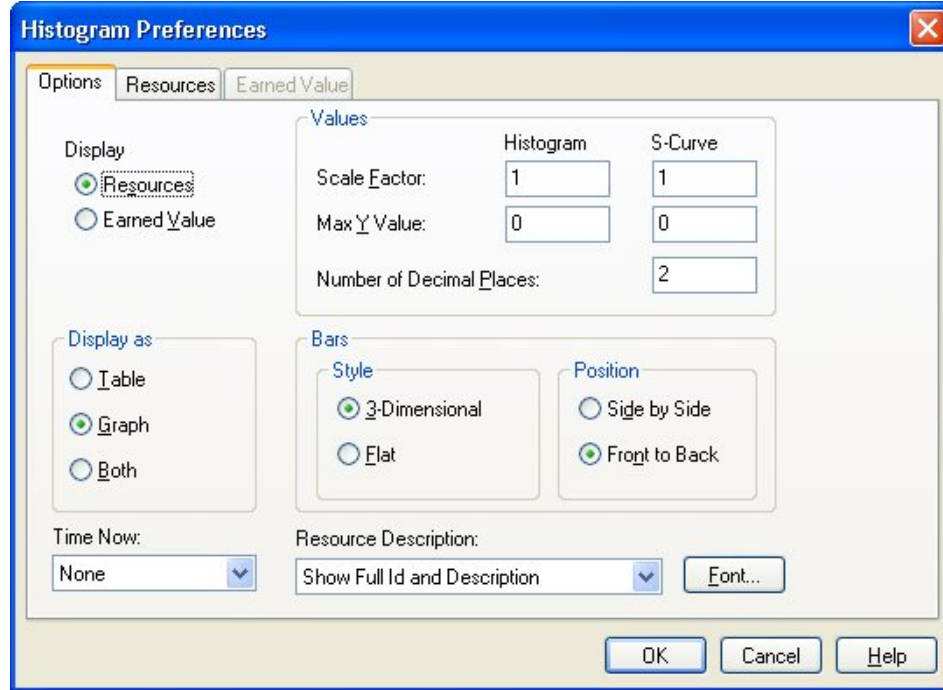

With this dialog box, you can indicate whether you want to display resource information or earned value information and if you want to display a graph only, a table only, or a combination of the two. If you display a table, you can indicate how many decimal places should be displayed.

You also have the option of specifying the bar style (3-dimensional or flat). If multiple bars are displayed, you can specify their display as either side-by-side or front-to-back. If you choose to display flat bars front-to-back, Open Plan varies the width of the bars to distinguish between the different types of information being displayed, for example:

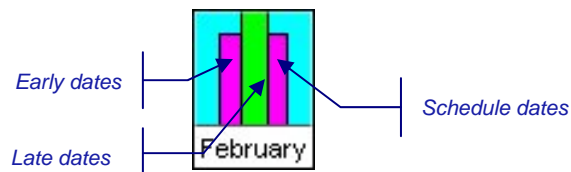

You can also set the following options:

- **Scale Factor** — This setting determines how Open Plan scales the values appearing in the histogram bar or S-curves. For no scaling, set the scale factor to 1.
- **Max Y Value** — This setting determines the highest value displayed on the vertical axis of the histogram bars or S-curves. To allow Open Plan to set a maximum value based on the data, leave this setting at 0.

- **Number of Decimal Places** — This field controls the number of decimal places that Open Plan should display on the histogram. You can specify any value between 0 and 5.
- **Time Now** — You can select from the following three options:
 - **None** — If you select this option, Open Plan does not display the Time Now line on the histogram.
 - **Line** — If you select this option, Open Plan identifies Time Now using a vertical line. There is no identifying text beside the Time Now line.
 - **Line with Text** — If you select this option, Open Plan identifies Time Now using a vertical line. In addition, the words "Time Now" are displayed next to the Time Now line.

If the histogram is displayed as a pane in the barchart view, Open Plan also features the following additional options:

- **Conditional Line** — If you select this option, Open Plan identifies Time Now using a vertical line only if the barchart identifies Time Now with a vertical line.
- If the barchart does not identify Time Now in this way, the histogram does not identify Time Now.
- **Conditional Text** — If you select this option, Open Plan identifies Time Now using both a vertical line and the text specified as the label in the Barchart Preferences dialog box only if the barchart identifies Time Now with a vertical line and a label.

If the barchart does not identify Time Now in this way, the histogram displays Time Now with only a vertical line.

- **Resource Description** — You can select from the following options:
 - **Show Full ID** — If you select this option, Open Plan identifies each resource by the full resource ID. For example, the resource may be identified as:
TEAM.LAB.JOAN
 - **Show Local ID** — If you select this option, Open Plan identifies each resource by the local portion of the resource ID. For example, the resource may be identified as:
JOAN
Where:
JOAN is the local portion of the TEAM.LAB.JOAN resource ID.
 - **Show Description** — If you select this option, Open Plan identifies each resource only by its description. For example, the resource may be identified as:
JOAN SHERWOOD
Where:
JOAN SHERWOOD is the resource description.
 - **Show Full ID and Description** — If you select this option, Open Plan identifies each resource by both the full resource ID and the description. For example, the resource may be identified as:

TEAM.LAB.JOAN JOAN SHERWOOD

Where:

TEAM.LAB.JOAN is the full resource ID.

JOAN SHERWOOD is the resource description.

- **Show Local ID and Description** — If you select this option, Open Plan identifies each resource by both the local portion of the resource ID and the description. For example, the resource may be identified as:

JOAN JOAN SHERWOOD

Where:

JOAN is the local portion of the resource ID.

JOAN SHERWOOD is the resource description.

- **Font** — Clicking this button displays the Font dialog box that you can use to customize the font used in the histogram view.

To define histogram display options

1. Take one of the following actions:

On the **Tools** menu, click **Histogram Preferences** (in a barchart view) or **Preferences** (in a histogram view).

Right-click anywhere in the view, and click **Preferences** on the context menu.

2. On the **Options** tab of the **Histogram Preferences** dialog box, enter the information for the display options.
3. When the information is complete, click **OK** to return to the view.

Customizing the Date Scale

You can customize the date scale appearing in a stand-alone resource histogram view using the same procedures that you use to customize the date scale in a barchart view. (In fact, when a resource histogram appears in a barchart view, the barchart date scale controls the histogram portion of the view as well.)



For information about customizing the date scale, refer to Chapter 18, “Barchart Views.”

Working with Risk Histograms

To display a risk histogram in Open Plan, the following conditions must be met:

- You must have performed risk analysis for the project.
- The project must have at least one activity designated as a key activity.
- You have selected an activity to display. (Use the **Select Activity** command from the **View** menu to indicate your selection.)

As in the case of resource histograms, each bar in a risk histogram represents a value corresponding to the smallest time unit displayed on the date scale. For example, if you define a date scale with the most detailed axis showing months, you can display bars that show how many times a key activity finished in a given month:

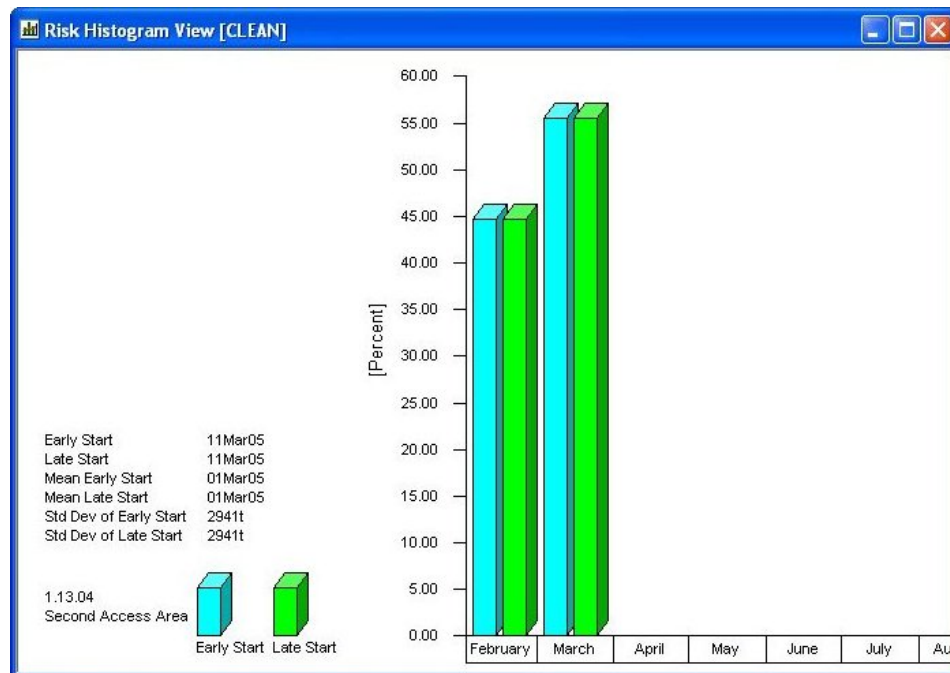

When you view a risk histogram, notice the legend to the left of the date scale. The legend includes information related to risk calculations — the mean values and standard deviations for the dates being displayed as well the equivalent date calculated by time analysis or resource scheduling. The legend also tells you the type of information appearing in the histogram, and how that information is displayed.

If you prefer to see the precise values being represented in the view, you can configure a risk histogram to display information in a tabular format below the bars:

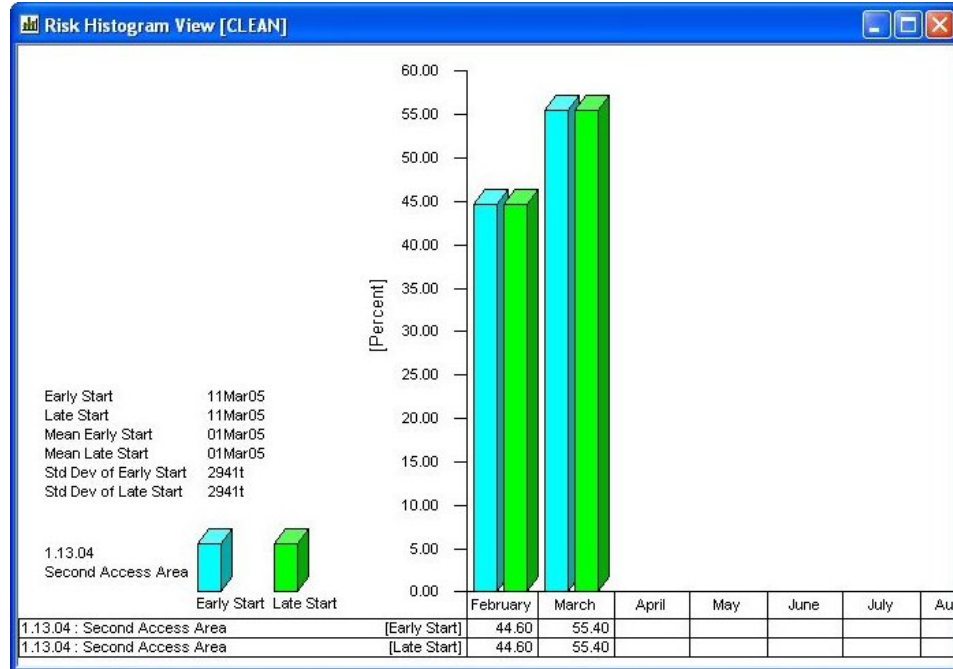

It is also possible to display just the tabular portion of the view.

As in the case of the histogram bars, the aggregation of tabular data corresponds to the smallest unit displayed on the date scale.

In addition to displaying information aggregated on a period-by-period basis, you can display S-curves representing the cumulative results of multiple trials:

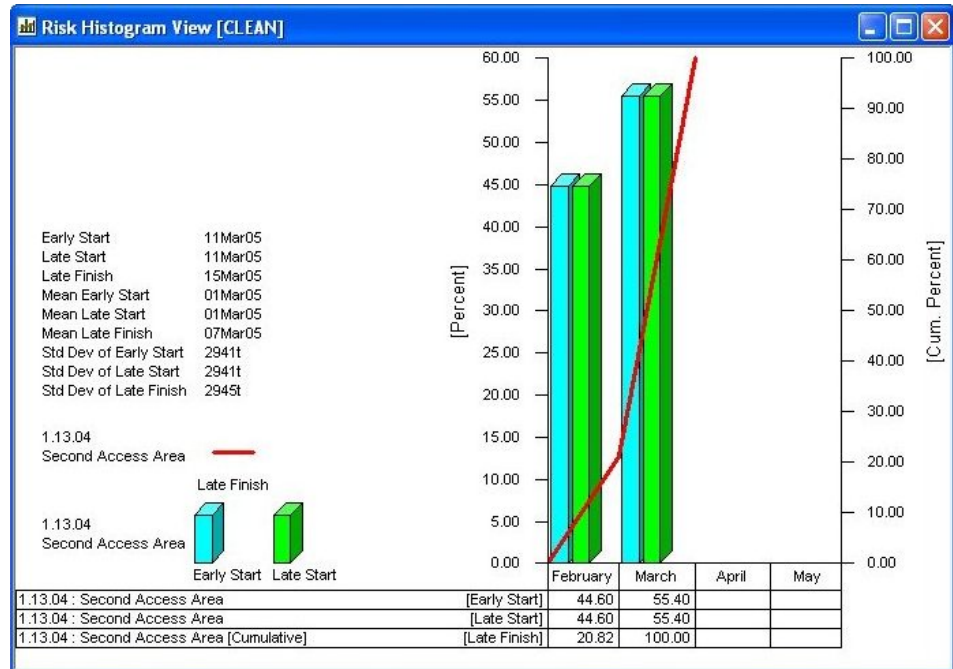

This feature is especially useful for estimating how much confidence is associated with a particular start or finish date.

Customizing Risk Histogram Views

Three operations allow you to customize risk histogram views in Open Plan:

- Selecting a key activity
- Defining histogram display options
- Customizing the date scale

Selecting a Key Activity

Open Plan allows you to select the activity that appears in the view using the following dialog box:

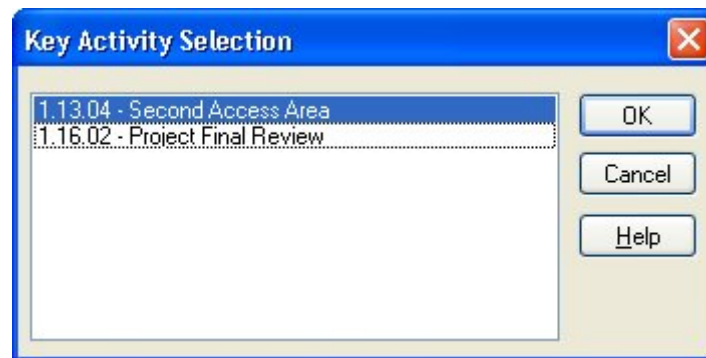

To select a key activity

1. Take one of the following actions:
 - On the **View** menu, click **Select Activity**.
 - Right-click anywhere in the view, and click **Select Activity** on the context menu.
2. Select an activity from the list displayed in the dialog box, and click **OK** to return to the view.

Risk Histogram Display Options

To define the appearance of a risk histogram view, display the **Risk Analysis Preferences** dialog box:

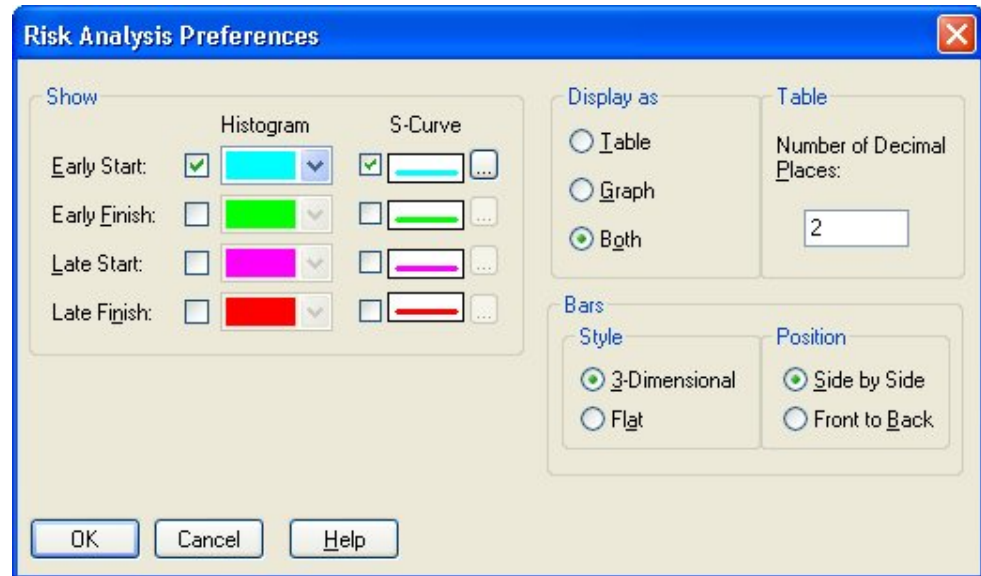

With this dialog box, you can indicate which dates (**Early Start**, **Early Finish**, **Late Start**, or **Late Finish**) to display in the view and whether you want to display histogram bars or cumulative S-curves. You can also indicate whether you want to display a graph only, a table only, or a combination of the two. If you display a table, you can indicate how many decimal places should be displayed.

If you are displaying histogram bars, you have the option of specifying the bar style (3-dimensional or flat). If multiple bars are displayed, you can specify their display as either side-by-side or front-to-back. If you choose to display flat bars front-to-back, Open Plan varies the width of the bars to distinguish between the different types of information being displayed.

To define risk histogram display options

1. Take one of the following actions:
 - On the **Tools** menu, click **Preferences**.
 - Right-click anywhere in the view, and click **Preferences** on the context menu.
1. Enter the information for the display options.
2. Click **OK** to return to the view.

Customizing the Date Scale

As in the case of a resource histogram, you can customize the date scale appearing in a risk histogram view using the same procedures that you use to customize the date scale in a barchart view.



For information about customizing a histogram date scale, refer to Chapter 18, "Barchart Views."

22

Importing and Exporting Files

➤ Overview	517
➤ Microsoft Project	518
➤ Primavera Project Planner	526
➤ Custom Import/Export Operations	528

Overview

Open Plan includes three facilities for importing and exporting project data:

- An import/export facility for Microsoft Project .mpd and .mpp files
- A basic import facility for projects created with Primavera Project Planner®.
- A customizable import/export facility based on user-defined scripts that can be used to transfer project data to and from a wide range of external applications

Microsoft Project

Open Plan features a seamless integration with the data formats used by Microsoft Project, allowing Open Plan to share project data files with it. This interface works directly with data from .mpd database files and accepts data in Microsoft Project's .mpp format.

System Requirements

In order to import and export Microsoft Project data, you must install Microsoft Data Access Components (MDAC) version 2.6.

The installation file MDAC is located in the MDAC folder of your Open Plan CD.



For additional information, refer to the Readme.txt file located in the MDAC folder on your Open Plan CD.

Importing Microsoft Project Data

Pointing to **Import** on the **File** menu and clicking **Import MSP File** on the submenu displays the following dialog box:

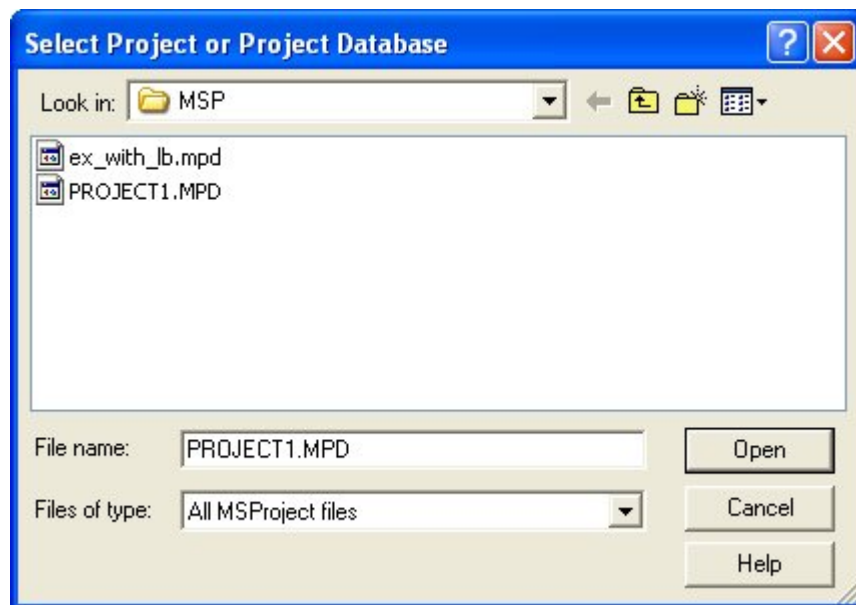

You can use this dialog box to locate and select the Microsoft Project file you want to import:

- Selecting a .mpp (Microsoft Project) file instructs Open Plan to display the **Load Options** dialog box.
- Selecting a .mpd (Project database) file instructs Open Plan first to display the **Select MSP Project** dialog box, which you then use to select a project contained in the .mpd file:

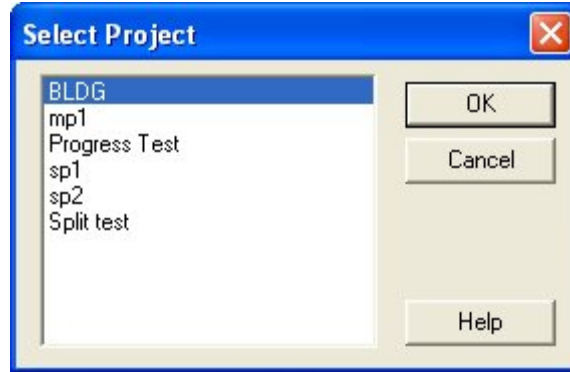

After selecting the project, click **OK** to display the **Load Options** dialog box.

The Load Options Dialog Box

The **Load Options** dialog box allows you to set the options that Open Plan uses when importing a project from Microsoft Project.



Unless inhibited by a previous setting, the **Load Options** dialog box is displayed automatically.

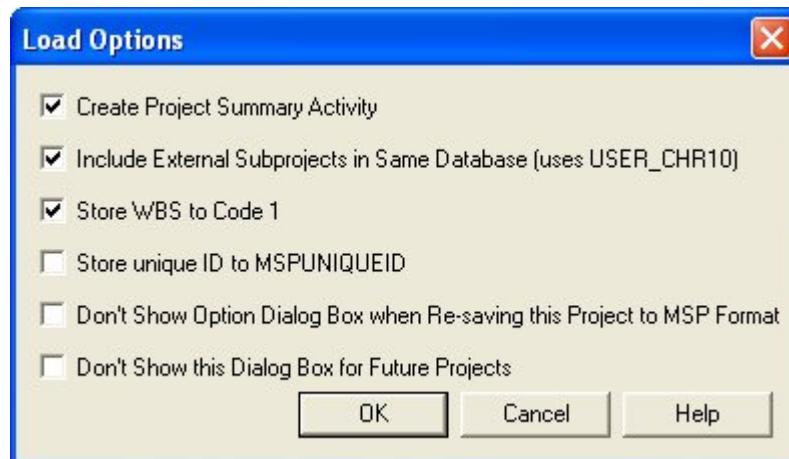

This dialog box contains the following options:

- **Create Project Summary Activity** — This option controls whether the Microsoft Project summary activity is copied to Open Plan.
 - If this option is selected, the Microsoft Project summary activity is copied to Open Plan and given the activity ID of 0. All the remaining activities have a prefix of 0.
 - If this option is not selected, the Microsoft Project summary activity is not copied to Open Plan.
- **Include External Subprojects in Same Database (uses USER_CHR10)** — This option should be selected if you are importing an .mpd file. If selected, this option brings all the external subprojects of the imported project that are in the same database into Open Plan as internal subprojects.

- **Store WBS to Code 1** — If WBS values have been assigned to the Microsoft Project activities, this option creates an Open Plan code file and stores the WBS values in the **Code 1** field.



The default values that appear in the Microsoft Project WBS field are actually the outline numbers and are not transferred as codes.

- **Store Unique ID in MSPUNIQUEID** — This option stores the MSP unique ID in the **MSPUNIQUEID** field in the Open Plan project.
- **Don't Show Option Dialog Box when Re-saving this Project to MSP Format**—Selecting this option inhibits the display of the **Save Options** dialog box when you resave the Open Plan project in one of the Microsoft Project formats.
- **Don't Show this Dialog Box for Future Projects** — Selecting this option saves the settings you have made and uses them for future Microsoft Project imports. If this option is selected, the dialog box is not displayed for any future projects. In order to redisplay this dialog box, you must change a setting in the Windows Registry.



For information on how to make the appropriate change in the Windows Registry, refer to Chapter 3, "Import and Export Facilities in Open Plan," in the *Deltek Open Plan Developer's Guide*.

To import a project from Microsoft Project



When performing this procedure, Microsoft Project must be present on your computer.

1. On the **File** menu, point to **Import**.
2. On the **Import** submenu, click **Import MSP File**.
3. From the **Select Project or Project Database** dialog box, select the Microsoft Project (.mpp) file, and click **Open**.

Open Plan displays the Microsoft **Planning Wizard**, which allows you to save the project with or without a baseline.

4. Select the appropriate option for your project, and click **OK**.

Open Plan displays the **Load Options** dialog box.



The **Load Options** dialog box is not displayed if an option has previously been set that inhibits its display.

5. From the **Load Options** dialog box, select the appropriate options for your project, and click **OK**.

Open Plan displays a **Save As** dialog box for each auxiliary file that it converts.

6. In each **Save As** dialog box, enter a name and location for the converted auxiliary file, and click **OK**.

7. When Open Plan displays a message stating that the data transfer completed successfully, click **OK**.
Open Plan creates an untitled project.
8. On the **File** menu, click **Save As** to enter a name for the new project file.
9. Click **OK**.

To import a Microsoft Project database file

1. On the **File** menu, point to **Import**.
2. On the **Import** submenu, click **Import MSP File**.
3. From the **Select Project or Project Database** dialog box, select the Microsoft Project database (.mpd) file, and click **Open**.
4. From the **Select MSP Project** dialog box, select the project that you want to import, and click **OK**.



The **Select Project** dialog box is displayed only when you select an .mpd (project database) file. It is not displayed if you select an .mpp file.

Unless an option has previously been set that inhibits its display, Open Plan displays the **Load Options** dialog box.

5. In the **Load Options** dialog box, select the options appropriate for your project, and click **OK**.

Open Plan displays a **Save As** dialog box for each auxiliary file that it converts.

6. In each **Save As** dialog box, enter a name for the converted auxiliary file, and click **OK**.
7. When Open Plan has completed the data transfer, click **OK**.
8. You can continue creating the project or choose to save it with a new filename for later use.

Exporting Microsoft Project Data

You can export data from an Open Plan project to a Microsoft Project file or project database. When you point to **Export** on the **File** menu and click **Export MSP File** on the submenu, Open Plan displays the **Save Project** dialog box:

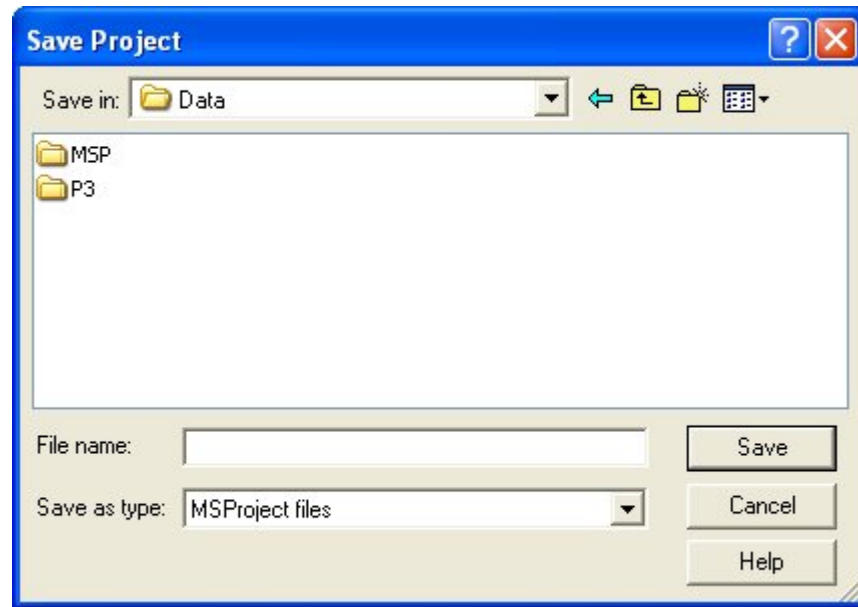

This dialog box allows you to choose the desired MSP format in which to export the file. The **Save as type** field offers you the following two options:

- **MSProject files** — This option limits the files displayed to those in the .mpp format and provides a default extension of .mpp to the file specified in the **File name** field.



For this option, you must have Microsoft Project installed on your computer.

- **MSProject databases** — This option limits the files displayed to those in the .mpd format and provides a default extension of .mpd to the file specified in the **File name** field. If you do not select an existing project name for the database, Open Plan creates a new MSProject database with the name you specify.



Before you can export a project to Microsoft Project, it must first be saved as an Open Plan project.

When you click **Save**, Open Plan displays the **Save Options** dialog box described in the following section.

The Save Options Dialog Box

The **Save Options** dialog box allows you to set the options that Open Plan should use when exporting a project into Microsoft Project. If the project that you are exporting originated as a Microsoft Project project and activities have been either added or deleted in Open Plan, Microsoft Project automatically renumbers the activities when it reopens the project. The order of the data and the outline level are preserved during the export process.

If the data originated in Microsoft Project, the **Save Options** dialog box values are set according to how the data was imported.

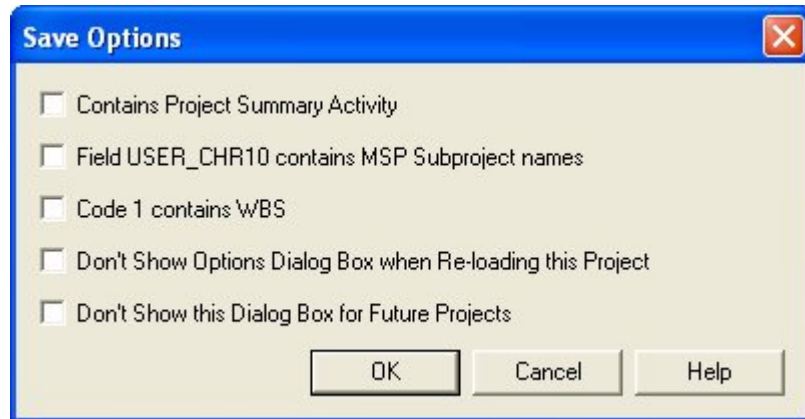

This dialog box contains the following options:

- **Contains Project Summary Activity** — This option indicates that the Open Plan project has a single activity with the ID 0 at the top level that represents the entire project. This option also controls how activities are numbered when the project is exported to Microsoft Project.
 - If this option is selected, the summary activity is given a unique ID of 0. Under normal circumstances, you would select this option for data that was previously imported from Microsoft Project with the **Create Project Summary Activity** option selected.
 - If this option is not selected, the top level activity is treated as a normal activity, and Microsoft Project automatically creates a summary activity.



This option also controls how the **Export** utility interprets the outline levels of all activities. For example, an activity ID of 0.1 is interpreted as level 1 if the option is selected; if the option is not selected, it is interpreted as level 2.

- **Field USER_CHR10 contains MSP Subproject Names** — Selecting this option indicates that the **USER_CHR10** field has been used to store Microsoft Project subproject names. The **Export** utility uses this information to recreate subprojects in the .mpd file. If the project is to be exported to the .mpp format, the information in the **USER_CHR10** field is discarded.
- **Code 1 Contains WBS** — Selecting this option indicates that the **Code 1** field has been used to store the WBS values. The **Export** utility uses this information to recreate WBS values.
- **Don't Show Option Dialog Box When Reloading this Project** — Selecting this option inhibits the display of the **Load Options** dialog box when reloading the Microsoft Project project into Open Plan.
- **Don't Show this Dialog Box for Future Projects** — If this option is selected, Open Plan saves the settings you have made and uses them for future exports to Microsoft Project. The dialog box is not displayed for any future projects. In order to redisplay this dialog box, you must change a setting in the Windows Registry.



For information on how to make the appropriate change in the Windows Registry, refer to Chapter 3, "Import and Export Facilities in Open Plan," in the *Deltek Open Plan Developer's Guide*.

The Select MSP Version Dialog Box

The **Select MSP Version** dialog box allows you to select the version of Microsoft Project that Open Plan should use when exporting the project into a Microsoft Project format:

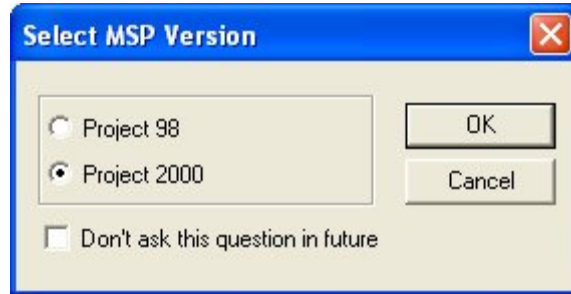

To export a project to Microsoft Project

1. Open the Open Plan project that you want to export.
2. On the **File** menu, point to **Export**.
3. On the **Export** submenu, click **Export MSP File**.
Open Plan displays the Save Project dialog box.
4. From the Save as type field, select MSPProject file.



If you select **MSPProject file**, Microsoft Project must be installed on your computer.

5. Provide a name and location for the MSP project, and click **Save**.



Open Plan saves the file with a default extension of .mpp. If you select an existing filename for the project, Open Plan prompts you for confirmation before overwriting the file.

Open Plan displays the **Save Options** dialog box.

6. Select the options you want to set for the export process, and click **OK**.



The **Save Options** dialog box is not displayed if an option has previously been set that inhibits its display.

7. From the **Select MSP Version** dialog box, select the version of Microsoft Project to export to, and click **OK**.

When Open Plan has completed transferring the project, the **Microsoft Project Planning Wizard** is displayed.

8. From the **Microsoft Project Planning Wizard**, choose whether the exported project should be saved with or without a baseline, and click **OK**.
9. When the **Export** utility displays a message indicating that the transfer has been completed successfully, click **OK**.

To export a project to a Microsoft Project database

1. Open the Open Plan project that you want to export.
2. On the **File** menu, point to **Export**.
3. On the **Export** submenu, click **Export MSP File**.
Open Plan displays the Save Project dialog box.
4. From the Save as type field, select MSPProject databases.
5. Provide a name and location for the MSPProject database, and click Save.



Open Plan saves the file with a default extension of .mpd. If you select an existing file name for the database, Open Plan adds the exported file to the selected database. Otherwise, the export utility creates a new Microsoft Project database with the name you specify.

6. In the **Project Name** dialog box, provide a name for the project to be added to the Microsoft Project database, and click **OK**.
Open Plan displays the **Save Options** dialog box.
7. Select the options you want to set for the export process, and click **OK**.



The **Save Options** dialog box is not displayed if an option has previously been set that inhibits its display.

8. From the **Select MSP Version** dialog box, select the version of Microsoft Project to export to, and click **OK**.
9. When the **Export** utility displays a message indicating that the transfer has been completed successfully, click **OK**.

Primavera Project Planner

Open Plan allows you to import and export both Primavera P3 and XER files.

Importing Primavera Files

The **Import Primavera File** utility allows you to import **P3** and **XER** projects from the Primavera Project Planner® system. This utility is accessed from the **Import** submenu on the **File** menu.

To import a P3 Btrieve file

1. On the File menu, click Import » Import Primavera File » P3 File.
2. From the Select P3 Project dialog box, select a Primavera P3 project, and click OK.
3. If a converted auxiliary file already exists in Open Plan, a New File dialog box is displayed for that file.
4. Enter a name for the converted auxiliary file, and click Finish.
5. When the data has transferred successfully, click OK.



For more information on importing P3 Btrieve files, refer to Chapter 3, "Import and Export Facilities in Open Plan," in the *Deltek Open Plan Developer's Guide*.

To import a XER file

1. On the File menu, click Import » Import Primavera File » XER.
2. From the Open dialog box, select the Primavera XER project, and click OK.
3. If a converted auxiliary file already exists in Open Plan, a New File dialog box is displayed for that file.
4. Enter a name for the converted auxiliary file, and click Finish.
5. When the data has transferred successfully, click OK.

Exporting Primavera Files

Open Plan allows you to export project data to either a batch file or XER file that can then be imported into Primavera.

To export P3 data

1. Open the project you wish to export.
2. On the **Add-Ins** menu, click **P3Export**.
3. On the **Save As** dialog box, enter a name and location for the batch file.
4. Click **Save**.
5. If errors are encountered during the export process, you are prompted to view the log. Click **Yes** to view the log; otherwise click **No**.

6. When finished viewing the log, close the window.

To export XER data

1. Open the project you wish to export.
2. On the **File** menu, point to **Export**, and click **Export General** on the submenu.
3. Select the **Primavera XER Format**, and click **OK**.
4. On the **Export File** dialog box, enter a name and location for the XER file.
5. Click **Save**.

Custom Import/Export Operations

In addition to the utilities for importing Microsoft Project and Primavera P3 and XER files and the utility for exporting Microsoft Project files, Open Plan also offers a more general capability based on user-defined import/export specifications. Each specification consists of a series of commands and parameters that allow Open Plan to import and export project, resource, code, and calendar information to a wide range of data formats.

Open Plan provides a number of standard import/export specifications that allow you, for example, to export a simple comma-delimited text file containing activity IDs and descriptions that can be read by many types of applications. It is also possible to create your own scripts for special-purpose operations.



For a complete description of creating custom import/export specifications, refer to Chapter 3, "Import and Export Facilities in Open Plan," in the *Deltek Open Plan Developer's Guide*.

Import General

To import project information, issue the **Import General** command to display the following dialog box:

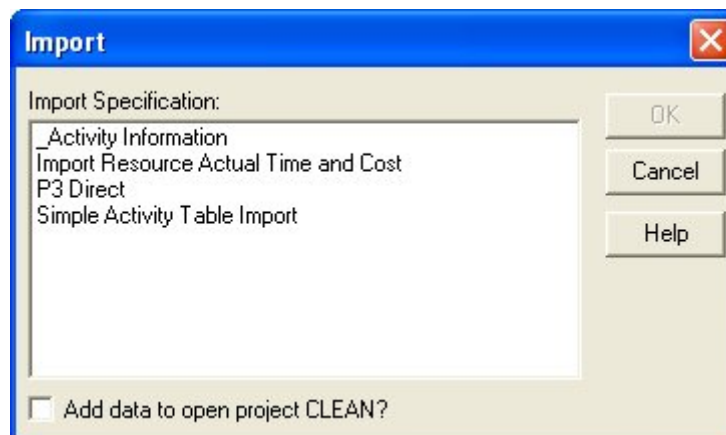

You can use this dialog box to select an import specification. When you click **OK**, Open Plan allows you to open a source data file and create an untitled project containing the imported information. If the project includes references to auxiliary data files such as resource or code files, Open Plan creates untitled versions of these files as well.

If you have a project open when you issue the **Import General** command, Open Plan allows you to indicate if the imported data should be used to update the current project. Note, however, that whether or not the imported data overwrites existing records is determined by a parameter set in the import specification.

To import project data

1. On the **File** menu, point to **Import**.
2. On the **Import** submenu, click **Import General**.
3. Select the specification for the operation.

You can also indicate if Open Plan should update the current project with the imported data.

4. When the information in the dialog box is correct, click **OK** to continue.

Open Plan allows you to open the source data file and then displays an untitled project for the imported project.

5. To save the project as an Open Plan project, click **Save** or **Save As**.

If the project includes references to auxiliary data files, you must save the auxiliary data files as well.

Export General

To export project information, issue the **Export General** command to display the following dialog box:

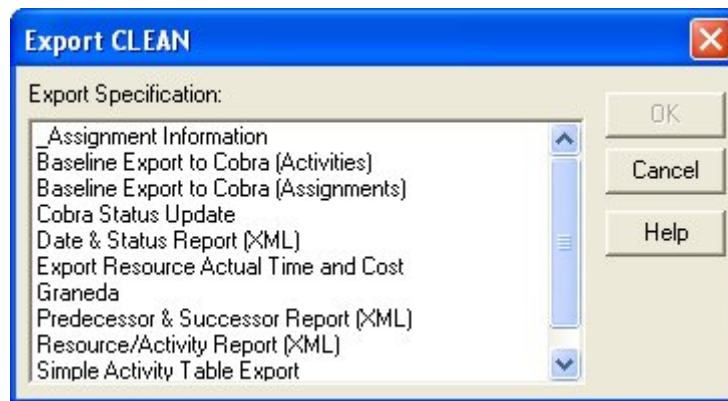

Use this dialog box to select an export specification.

To export project data

1. Open the project you want to export.
2. On the **File** menu, point to **Export**.
3. On the **Export** submenu, click **Export General**.
4. Select the export specification for the operation.
5. When the information in the dialog box is correct, click **OK**.

Open Plan allows you to specify the destination file for the operation.

Crosstable Exports

To export crosstable data, open the **File** menu and click **Export**, then **Export Crosstable Data** to open the **Crosstable Exports** dialog box.

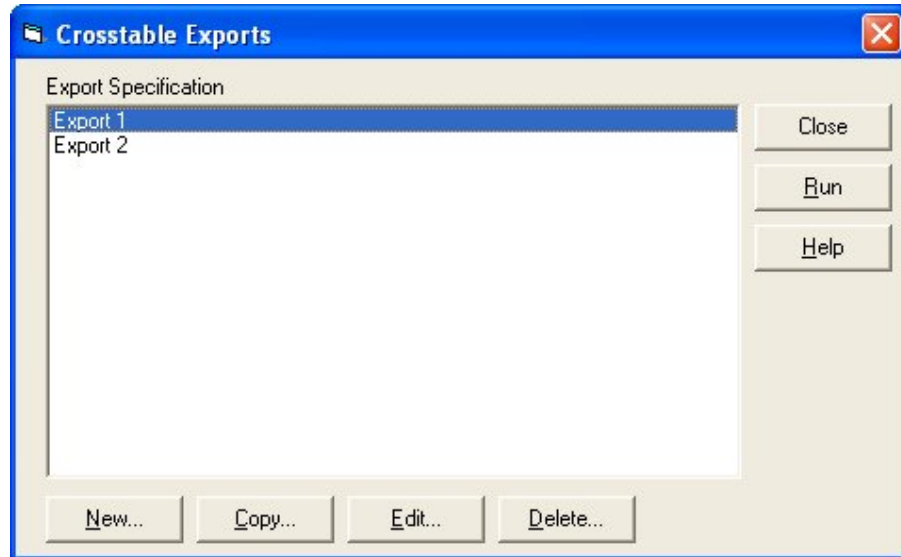

The export specifications listed on this dialog box include those that you have created as well as those that other users have created and chosen to share. When you select an export specification and click **Run**, you are given the opportunity to save the export file in either .xml or .csv format. You may also click on **View** to see those export files that have been utilized in the past.



Elements that have a value of zero are exported as a blank value instead of a zero (0).

The buttons along the bottom of the dialog box allow you to create, copy, edit, and delete export specifications. When you create, copy, or edit an export specification, a tabbed dialog box allows you to select the elements to include in the export file. The default view is the **General** tab.

General Tab

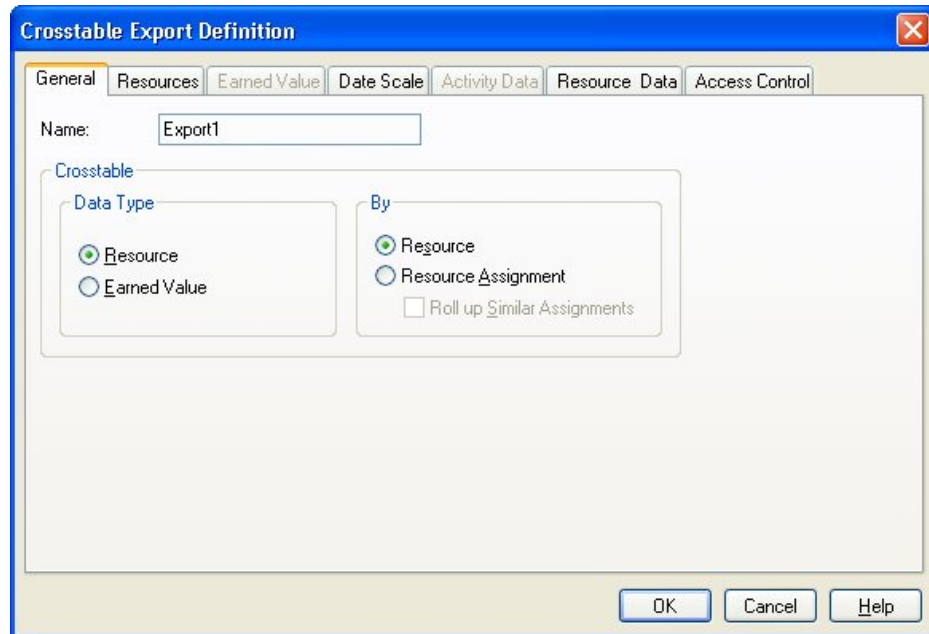

The **General** tab of the **Crosstable Export Definition** dialog box features the following choices that determine the type of data to export and enables or disables the appropriate tabs.

For **Data Type**, you can choose between the following:

- **Resource** — Select this option to export resource data and to enable the **Resources** tab. Resource data is demand based on the following:
 - Early, late, or scheduled dates
 - Availability
 - Actuals
 - Baseline
- **Earned Value** — Select this option to export earned value data and to enable the **Earned Value** tab. Earned value data includes the following:
 - Budget
 - Actual
 - Forecast
 - Earned Value

Once you have decided what type of data to export, you can choose to export the data rolled up by:

- **Resource** — Select this option to export the data rolled up by resource and to enable the **Resource Data** tab.
- **Resource Assignments** — Select this option to export the data rolled up by resource assignment and to enable the **Activity Data** tab.

- **Roll up similar Assignments** — When the **Resource Assignments** option is chosen, this option becomes available. Selecting this option instructs Open Plan to roll up similar assignments.

Resources Tab

The **Resources** tab is enabled when you select **Resource** as the Data Type on the **General** tab.

You can export the resource **Availability** as well as any of the following types of resource data:

- **Early** — Selecting this option exports the resource values (quantity, cost, and/or escalated cost) by early dates.

 Early dates are calculated in time analysis as the earliest dates on which activities can start and finish.

- **Late** — Selecting this option exports the resource values (quantity, cost, and/or escalated cost) by late dates.

 Late dates are calculated in time analysis as the latest dates on which activities can start and finish without delaying the project.

- **Schedule** — Selecting this option exports the resource values (quantity, cost, and/or escalated cost) by schedule dates, also known as resource usage.

 Schedule dates are the activity start and finish dates calculated by resource scheduling.

- **Actual** — Selecting this option exports the resource values (actual quantity, actual cost, and/or actual escalated cost) by actual dates.

- **Baseline** — Selecting this option allows you to choose up to 3 baselines attached to the project. Open Plan exports the baseline resource values (quantity, cost, and/or escalated cost) for each selected baseline.

For the resource data you select, you can export any of the following values:

- **Quantity** — For each of the **Usage** options you select, the **Quantity** option instructs Open Plan to export the resource quantity values when calculating usage.
- **Cost** — For each of the **Usage** options you select, the **Cost** option instructs Open Plan to export the unescalated resource cost values.
- **Escalated Cost** — For each of the **Usage** options you select, the **Escalated Cost** option instructs Open Plan to export the escalated resource cost values.

You can also select one of the following methods for calculating the values to export:

- **Period** — Selecting this option instructs Open Plan to calculate the resource usage by period.



The periods used are determined by the selection you make on the **Date Scale** tab.

- **Cumulative** — Selecting this option instructs Open Plan to calculate the resource usage as cumulative to date for each period exported.
- **Average** — Selecting this option instructs Open Plan to calculate the average resource usage. The average value is expressed in terms of the default duration defined for the project. For example, if the default duration is weeks, an average of 4 would mean 4 resource units per week. When calculating the average value, Open Plan uses the calendar assigned to the first availability record for each selected resource.

Earned Value Tab

The **Earned Value** tab is available when you select **Earned Value** as the Data Type on the **General** tab.

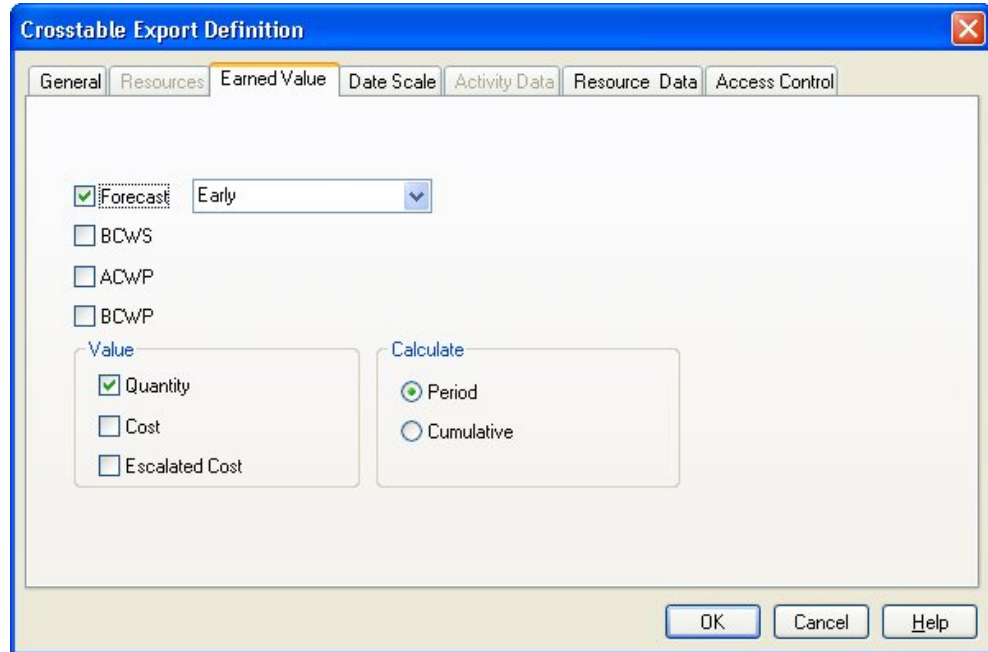

You can export the following earned value data:

- **Forecast** — Selecting this option allows you to export forecast data (quantity, cost, and/or escalated cost) based on early, late, or schedule dates.
- **BCWS** — Selecting this option allows you to export budgeted cost of the work scheduled data (quantity, cost, and/or escalated cost) according to the baseline dates.
- **ACWP** — Selecting this option allows you to export actual cost of the work performed (quantity, cost, and/or escalated cost) that has been calculated, entered, or imported.
- **BCWP** — Selecting this option allows you to export the budgeted cost of work performed data (quantity, cost, and/or escalated cost).

For the earned value data you select, you can export any combination of the following values:

- **Quantity** — Selecting this option instructs Open Plan to calculate and export the resource quantity values.
- **Cost** — Selecting this option instructs Open Plan to calculate and export the unescalated resource cost values.
- **Escalated Cost** — Selecting this option instructs Open Plan to calculate and export the escalated resource cost values.

You can also select one of the following methods for calculating the values to export:

- **Period** — Selecting this option instructs Open Plan to calculate the earned value by period.

 The periods used are determined by the selection you make on the **Date Scale** tab.

- **Cumulative** — Selecting this option instructs Open Plan to calculate earned value cumulative to date.

Date Scale Tab

The **Date Scale** tab allows you to specify the time periods Open Plan uses to calculate and export the data. The time periods are then used to display the calculations in the .csv or .xml export file. You can also set the range of dates that Open Plan uses for the operation.

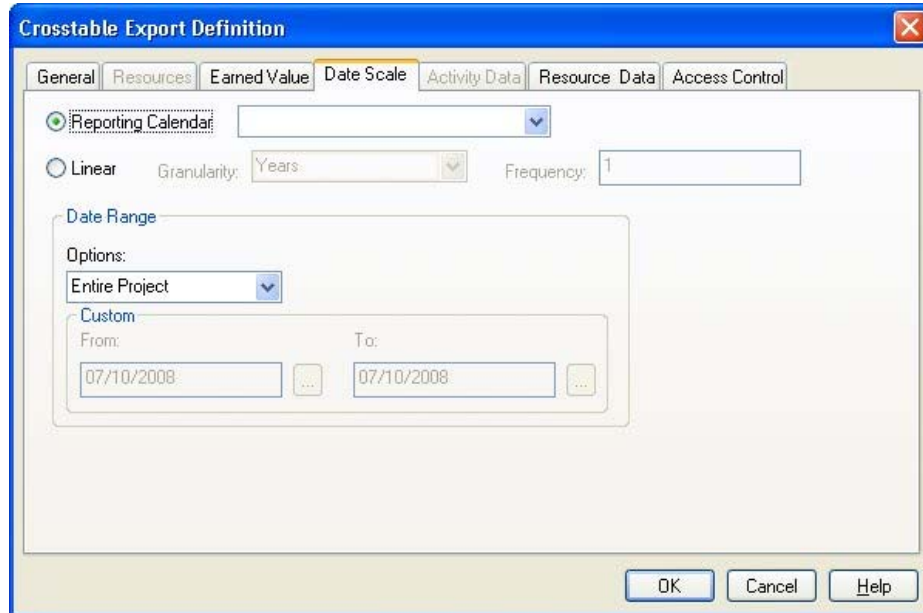

You can select one of the following options to specify the time periods:

- **Reporting Calendar** — Selecting this option allows you to use the time periods in an existing reporting calendar when calculating and exporting the data. Reporting calendars allow you to view the exported time-based data against a non-linear date scale with varying degrees of granularity.

The fiscal calendar is a reporting calendar assigned to the project on the **Cost** tab of the **Project Properties** dialog box. This is useful if your company uses a fiscal calendar that contains periods that do not end on the last day of the month.

 By exporting data using different reporting calendars, you can create reports that provide different views of the same data.

- **Linear** — Selecting this option allows you to set the **Granularity** and **Frequency** of the time periods Open Plan uses when calculating and exporting the data.
- **Granularity** — This field controls the time period to use to calculate and export the data. You can select from years, quarters, months, weeks, days, and hours.

- **Frequency** — This field allows you to set the frequency of the time periods Open Plan uses. For example, if you set a **Granularity** of months with a **Frequency** of 3, the data would be calculated and exported using time periods similar to the following:
 - 01/01/2003
 - 04/01/2003
 - 07/01/2003
 - 10/01/2003
 - 01/01/2004



The options in the **Date Range** portion of the dialog box allow you to control the time span for the data that Open Plan exports.

The **Date Range** section allows you to set the dates in the **From** and **To** fields that Open Plan uses when calculating and exporting the data. You can select from the following options:

- **Custom** — Selecting this option allows you to set the **From** and **To** dates manually.
- **Entire Project** — Selecting this option instructs Open Plan to use the project's **Start Date** and **Schedule Finish Date**.
- **Time Now** — Selecting this option instructs Open Plan to use **Time Now** for the **From** date but allows you to enter the **To** date manually.
- **Project Start** — Selecting this option instructs Open Plan to use the project's Start Date for the **From** date but allows you to enter the **To** date manually.



You can enter a date directly into the **From** and **To** fields or click the **ellipsis** button next to a field to display a pop-op calendar which you can use to select a date.

Activity Data

The **Activity Data** tab is enabled when you select the option to export the data rolled up by **Resource Assignment** (on the **General** tab).

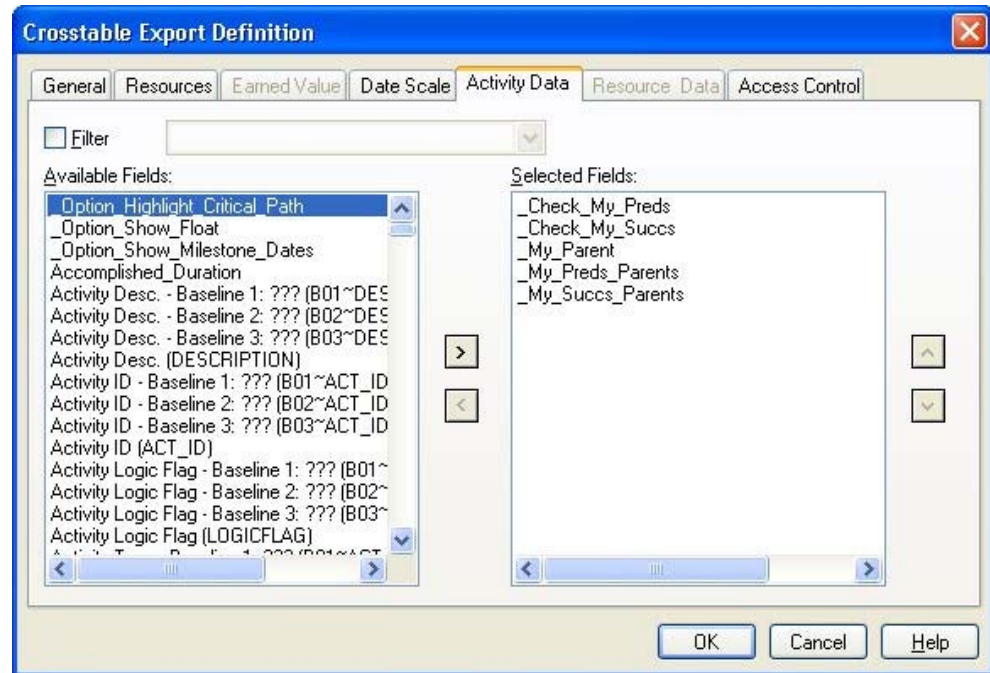

This tab allows you to do two things:

- Apply a filter to the activities that are exported
- Export additional activity fields that are available to the project

Selecting the **Filter** option enables a list that you can use to select an existing filter to apply to the project activities. The activities that are returned by the filter are used in the export specification.

The **Available Fields** list contains all of the activity-related fields included in the project. To include a field in the export specification, simply select it, and click the right arrow button. It is moved to the **Selected Fields** list where you can use the up and down arrows to arrange the fields in the order in which you want to export them. To remove a field from the export specification, select it in the right-hand list, and click the left arrow button.



You can move multiple fields from one list to the other at one time by **Ctrl**+clicking or **Shift**+clicking the desired fields and clicking the appropriate arrow button.

Resource Data

The **Resource Data** tab is enabled when you select the option to export the data rolled up by **Resource** (on the **General** tab).

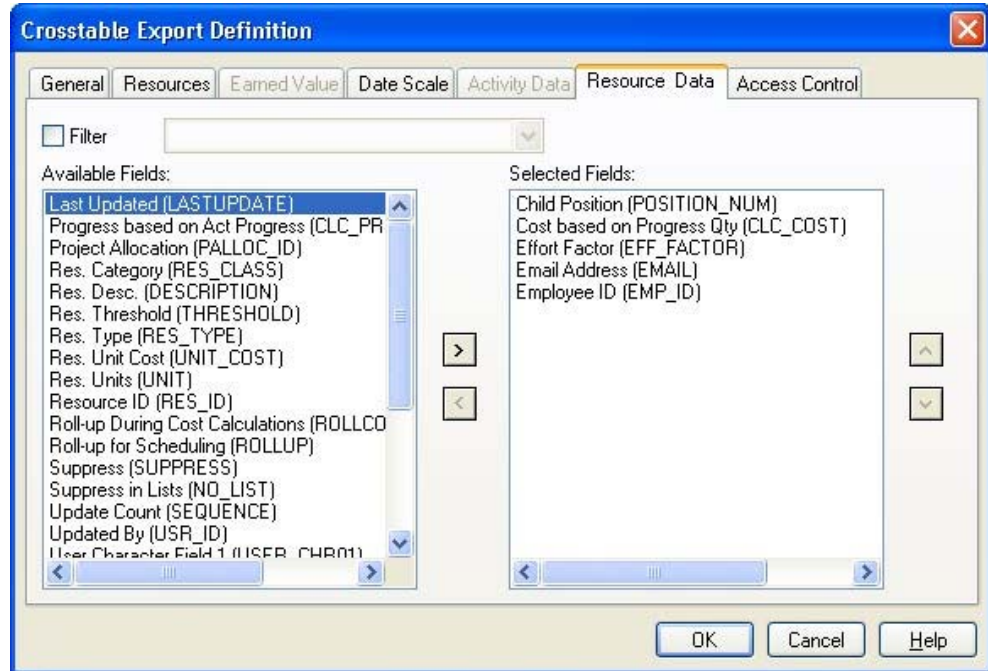

This tab allows you to do two things:

- Apply a filter to the resources that are exported
- Export additional resource fields that are available to the project

Selecting the **Filter** option enables a list that you can use to select an existing filter to apply to the project resources. The resources that are returned by the filter are used in the export specification.

The **Available Fields** list contains all of the resource-related fields included in the resource file. To include a field in the export specification, select it and click the right arrow button. It is moved to the **Selected Fields** list where you can use the up and down arrows to arrange the fields in the order in which you want to export them. To remove a field from the export specification, select it in the right-hand list, and click the left arrow button.



You can move multiple fields from one list to the other at one time by **Ctrl**+clicking or **Shift**+clicking the desired fields and clicking the appropriate arrow button.

Access Control

The **Access Control** tab allows you to define the access rights that users or groups have and what role they play in the project.

The screenshot shows the 'Crosstable Export Definition' dialog box with the 'Access Control' tab selected. The 'Name' field contains 'Export1' and the 'Owner' dropdown is set to 'SYSADMIN - System Administrator'. Below these fields is a table with the following columns: Group, Role, User ID, and Read Only. The 'Read Only' column has a dropdown menu with 'Yes' and 'No' options. The table is currently empty.

If you are the owner of the project or a member of the System Administrator group and you have the project open in **Exclusive** mode, you can use the following fields to define access rights to the project:

- **Owner** — You can change the owner of the project by selecting a new owner from the list.



If you provide access rights to a group for a project, members of that group automatically inherit read rights to all resource files, calendar files, code files, and external subprojects assigned to that project. Note, however, that it is possible that after you change the ownership of a project to another user, you may not have rights to save the project. If this occurs, simply close the project without saving.

- **Group** — By selecting a field in this column and selecting a group from the list, you can specify the group(s) that can have access to the project.
- **Role** — When you select a group or user ID, its default role is automatically entered in this field. You can then change default role to any role that has been defined in the data source.
- **User ID** — By selecting a field in this column and selecting a user ID from the list, you can specify the users that can have access to the project.
- **Read Only** — By selecting **Yes** for this field, you limit the group or user to opening the project in **Read Only** mode. By selecting **No** for this field, Other users may open the file in any mode they choose. **Read Only** mode has the following limitations:
 - In order to make changes to the project, you must first save the project under a different name.

- You cannot see changes made by other users.



In order to see changes made by other users who may have the project open in **Exclusive** or **Shared** mode, you have to close and reopen the project.

23

Project Utilities

➤ Overview	543
➤ Filters.....	544
➤ Sorts.....	553
➤ Calculated Fields.....	561
➤ Rollup	566
➤ Global Edit.....	569
➤ User Defined Fields.....	576
➤ Spread Curves	580

Overview

Open Plan includes a number of project-level utilities that facilitate the manipulation of project data. These include:

- Filters
- Sorts
- Calculated fields
- Global edits
- User-defined fields
- Spread curves

This chapter discusses each of these features in turn.

Filters

Filters limit the display of items in a view based on a specific criterion. For example, you may wish to display a view that shows only activities requiring a particular resource. Open Plan provides a number of predefined filters common to many project management reports. In addition to these predefined filters, you can define custom filters of your own.

When applying a filter to a view, keep the following points in mind:

- When selecting filtered activities, the status of the parent item determines the status of the child. For example, assume that you apply a filter to a view and then select a parent activity or resource pool. This selects all children of the item, even if they do not meet the original filter criteria.
- If you apply a filter to a spreadsheet or barchart view with outlining turned on, the status of child items is determined by the status of the parent when you select the **Filter from the Top Down** option. For example, if a parent activity fails to meet the criteria of a filter, none of that parent's children will appear in the view, even in cases where the individual child activities satisfy the filter.
- If you apply a filter to a linked spreadsheet view, the filter applies only to information from the primary data table for the view.



For information about outlining and linking in spreadsheets, refer to Chapter 20, "Spreadsheet Views."

Using Filters

To display a list of available filters, click the **Filters** command on the **Tools** menu. Open Plan responds by displaying the following dialog box:

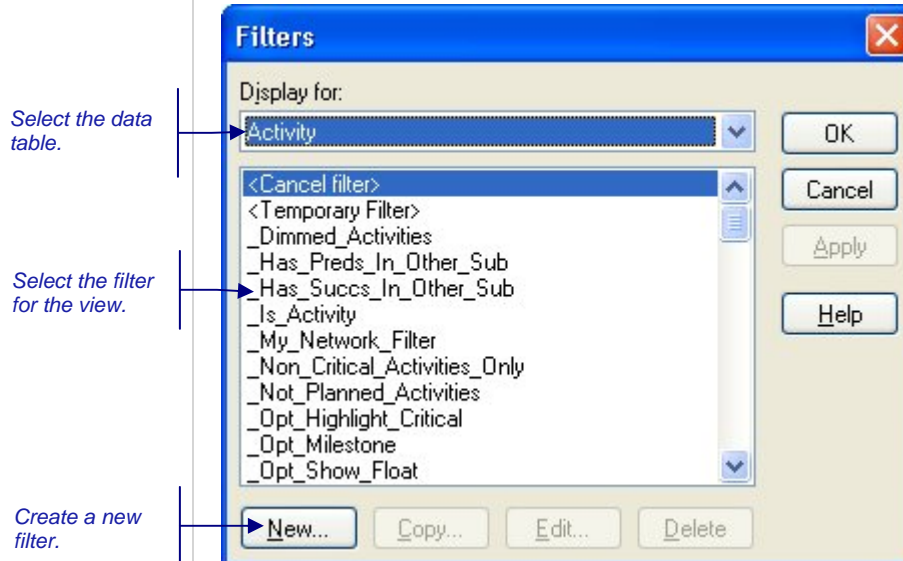

Each view for a project can have a different filter in effect. The name of the filter currently in effect appears in the status bar at the bottom of the Open Plan window:

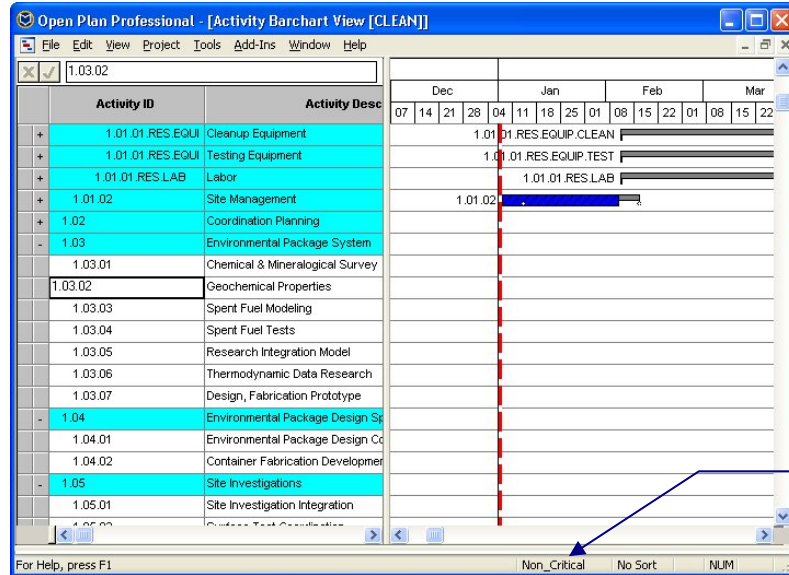

To reapply the filter (or the sort) without exiting the view, click the **Refresh** button on the toolbar.

Once a filter is in effect for a view, you can continue to add items to the view. Open Plan displays the items as you add them, even if the new items do not satisfy the current filter condition. However, if you refresh the view or close the view and return to it later, the items you added may not be displayed if the filter expression excludes them.

To apply a filter in a network view, you must use the **Placements** command.



For more information on applying a filter in a network view, refer to Chapter 19, "Network Views."

To apply a filter

- Take one of the following actions:
 - On the Tools menu, click Filters » Manage Filters.
 - Right-click within the view, and click Filters on the context menu.
- From the **Filters** dialog box, select the filter you want to apply.
- Click **OK**.

To refresh a filter

- On the toolbar, click the **Refresh** button.

To cancel a filter

- Take one of the following actions:
 - On the Tools menu, click Filters » Manage Filters.
 - Right-click within the view, and click Filters on the context menu.
- From the **Filters** dialog box, select **<Cancel filter>**, and click **OK**.



Defining Filter Expressions

Open Plan allows you to define custom filter expressions that can be applied to views of project information. These custom expressions can be based on any field from the activity- or resource-related data tables and can feature complex expressions using logical operators and parentheses. Once you create a filter, you can make that filter available to other users in the network.

In addition to their use as view filters, filter expressions can appear as criteria for bar attributes in a barchart view or for box attributes in a network view.

When you create a new filter, Open Plan displays a dialog box in which you can enter a filter name and indicate the source of the fields to appear in the filter.

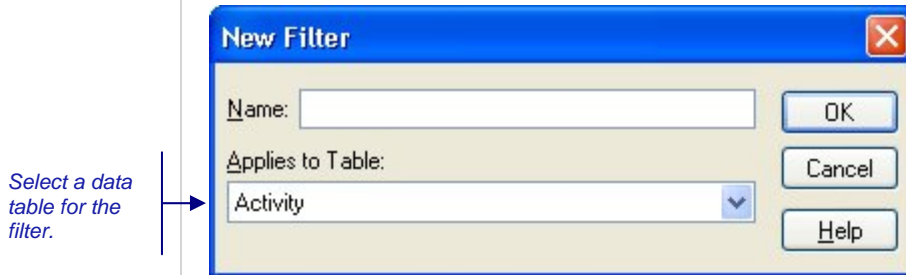

Once you have entered a name and a data table for the filter, Open Plan allows you to enter the expression for the filter criterion using the following dialog box:

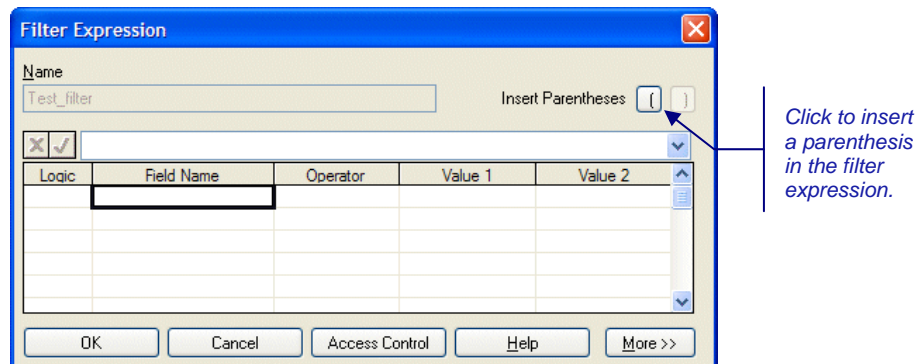

With this dialog box, you can build a filter using the following components:

- **Logic** — You can build complex filter expressions using the following logical operators:
 - AND
 - AND NOT
 - OR
- **Field Name** — Filter expressions can include any field from the selected data table, including calculated fields and any filters already defined for that table. Previously defined filters specified as fields can have one of two values: true or false.



For information about calculated fields, refer to the “Defining Calculated Fields” section in this chapter.

- **Operator** — Filter expressions can contain any of the following operators:
 - Between
 - Contains
 - Equals
 - Greater or Equals
 - Greater Than
 - Is Empty (available for text fields only)
 - Less or Equals
 - Less Than
 - Not Between
 - Not Contains
 - Not Empty (available for text fields only)
 - Not Equals



The **Contains** operator is case-sensitive. Criteria entered using this expression must be typed in the same case as the original value. If the same case is not used, no results will be displayed.

- **Value 1** — The values available for a filter expression depend on the type of field used in the expression. For example:
 - If you select a text, numeric, or date field, Open Plan allows you to select another field from the table (including calculated fields and previously defined filters), or you can enter a text, numeric, or date constant.

If you are defining a filter that includes an activity or resource ID, make sure that you enter the value using upper-case characters.
 - If you select an enumerated field for the expression, Open Plan displays a list of valid choices from which you must select. For example, the **Activity Type** field is an enumerated field with valid values such as ASAP, ALAP, or Start Milestone.
 - If you select a logical field for the expression, Open Plan allows you to select either true or false as a value.
- **Value 2** — If the expression uses either the **Between** or **Not Between** operators, you can enter a second value for the filter.
- **Insert Parentheses** — You can insert a left and right parenthesis in any expression. Left parentheses can be inserted at the beginning of the **Field** column; right parentheses can be inserted at the end of a row in the **Value 2** setting. Parentheses allow you to develop complex expressions such as the following examples:
 - C1 Equals "1.1" AND (C2 Equals "QA" OR C2 Equals "Pubs")
 - (C1 Equals "1.1" AND C2 Equals "QA") OR C2 Equals "Pubs"

When you click **More**, the **Filter Expression** dialog box extends to display additional controls:

- **Expression** — This field reflects the actual expression that is displayed in the grid. If you prefer, you can enter the filter expression directly in the text box.
- **Fields** — Clicking this button displays the **Fields** dialog box. You can use this dialog box to select fields to include in the filter expression.
- **Functions** — Clicking this button displays the **Functions** dialog box. You can use this dialog box to select functions to use in the filter expression.
- **Validate** — When you have created a filter expression, you can click this button to have Open Plan validate the expression. If the filter expression is valid, Open Plan populates the grid with the appropriate values.
- **Access Control** — Select this option to grant rights to other users in the data source to use the filter expression.
- **References** — Clicking this button displays the References dialog box, which has a list of items that use the sort. This list of items includes the file type, name of the project or file, description, and owner.
- **Less** — Clicking this button hides the dialog box extension.

To add a filter expression

1. On the **Tools** menu, click **Filters » Manage Filters**.
2. When Open Plan displays a list of existing filters, click **New**.
3. In the **New Filter** dialog box, enter a name, and select a source data table for the new filter.
4. Click **OK**.
5. In the **Filter Expression** dialog box, define the filter expression.
6. When the information for the filter expression is complete, click **OK** to return to the **Filters** dialog box.

To edit a filter expression

1. On the **Tools** menu, click **Filters » Manage Filters**.
2. Select the filter you want to change, and click **Edit**.

3. In the **Filter Expression** dialog box, update the filter expression.
4. When the information for the filter expression is complete, click **OK** to return to the **Filters** dialog box.

To copy a filter expression







1. On the **Tools** menu, click **Filters » Manage Filters**.
2. Select the filter you want to copy, and click **Copy**.
3. In the **Filter Expression** dialog box, enter a new name for the filter.
4. When the information for the new filter expression is complete, click **OK** to return to the **Filters** dialog box.

To delete a filter expression

1. On the **Tools** menu, click **Filters » Manage Filters**.
2. Select the filter you want to delete, and click **Delete**.
3. When Open Plan asks you to confirm the deletion, click **Yes**.

Additional Filtering Options

The following options are also available for filtering:

- **Add to Filter**  — This option takes a selection range and adds the selection values to the currently selected filter based on the following rules:
 - Multiple selections within a column are added to the filter with an OR EQUALS condition
 - Multiple selections across columns are added to the filter with an AND EQUALS condition
- **Remove from Filter**  — This option takes a selection range and adds the selection values to the currently selected filter based on the following rules:
 - Multiple selections within a column are added to the filter with an OR NOT EQUALS condition
 - Multiple selections across columns are added to the filter with an AND NOT EQUALS condition
- **Clear Filter**  — This option removes the currently selected filter. It is equivalent to displaying the **Manage Filters** dialog box and choosing **Cancel Filter**.
- **Toggle Filter**  — Once a filter has been applied, this option turns the filter on or off while still remembering it.
- **Edit Expression**  — This option displays the Filter Expression dialog box while bypassing the Manage Filters dialog box.
- **Reapply Filter/Sort**  — Select this option to apply the last filter and sort again.

To apply one of these options, follow these steps:

1. On the **Tools** menu, click **Filters**.
2. Select the appropriate option (for example, **Add to Filter**).

Temporary Filters

In addition to creating permanent filters, you can also create temporary filters. Temporary filters are available only in the view in which they are defined and valid until superceded by another filter. You cannot make these temporary filters available to other projects, nor can you make them available to other users with the **Share this Item with Others** option.

Temporary filters can be created in two ways:

- By selecting **<Temporary Filter>** on the **Filters** dialog box.

Creating a temporary filter in this manner uses the same **Filter Expression** dialog box used for creating a new filter but with two exceptions: the name of the filter is **<temporary>** and the **Share this Item with Others** option is disabled.

- By typing the temporary filter expression directly in the field where it will be used.

For example, you can type the temporary filter expression directly into the **Criterion** field on the **Bar Attributes** tab of:

- The Bar Set Preferences dialog box
- The Network View Preferences dialog box

The manner in which the **Filter Expression** dialog box for a temporary filter is displayed depends on the view from which it is accessed:

- In network views, you can display the **Filter Expression** dialog box for a temporary filter by clicking **Filters** on the **Placements** dialog box and then selecting **<Temporary Filter>** from the **Filters** dialog box.
- In spreadsheet and barchart views, you can display the **Filter Expression** dialog box for a temporary filter by clicking **Filters** on the **Tools** menu and then selecting **<Temporary Filter>** from the **Filters** dialog box.



The temporary filter created in this manner can be applied only to a primary table. In multi-table views, you can apply a filter to a secondary table using the **Define Link** tab of the **Spreadsheet Preferences** dialog box.

To define a temporary filter using the Filter Expression dialog box

1. Display the view in which you want to apply the temporary filter.
2. On the **Tools** menu, click **Filters**.
Open Plan displays the **Filters** dialog box.
3. Take one of the following actions:
 - Select **<Temporary Filter>**, and click **Edit**.
 - Double-click **<Temporary Filter>**.
4. In the **Filter Expression** dialog box, define the temporary filter in the grid.



Click **More** to expand the **Filter Expression** dialog box if you want to use the **Fields** and **Functions** buttons as an aid in building your filter expressions.

5. Click **OK**.

To define a temporary filter in a Network view

1. On the **View** menu, click **Placements**.
2. On the **Placements** dialog box, click the **Filters** button to display the **Filters** dialog box.
3. Take one of the following actions:
 - Select <Temporary Filter>, and click **Edit**.
 - Double-click <Temporary Filter>.
4. In the **Filter Expression** dialog box, define the temporary filter in the grid.



Click **More** to expand the **Filter Expression** dialog box if you want to use the **Fields** and **Functions** buttons as an aid in building your filter expressions.

5. Click **OK**.

Temporary Filters on a Secondary Table

You can apply a temporary filter to a secondary table in a multi-table view by using the **Define Link** tab of the **Spreadsheet Preferences** dialog box:

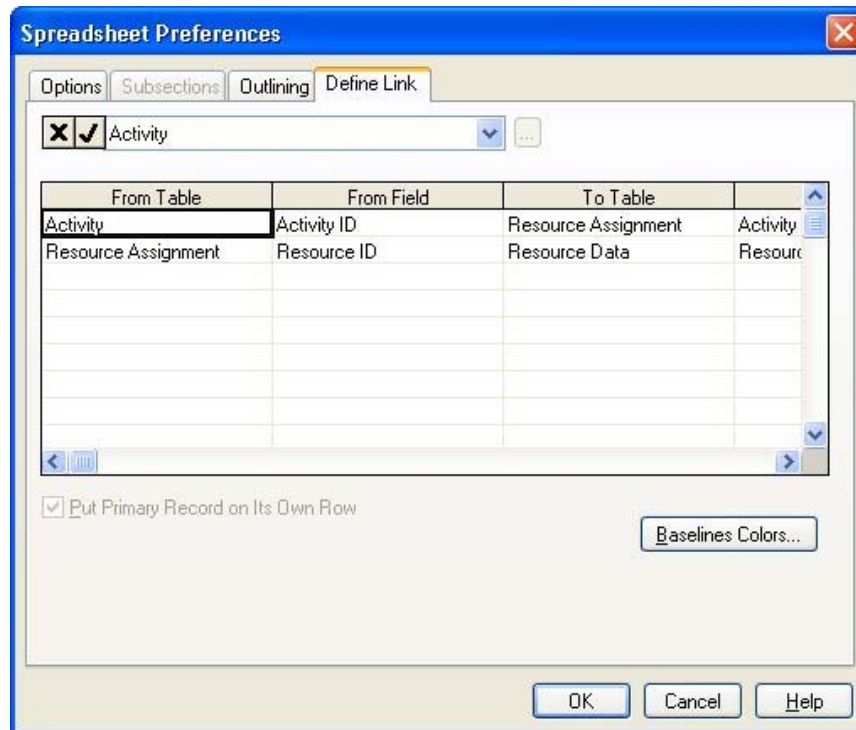

The **Define Link** tab applies to the Professional edition of Open Plan only.

The filter for data from all subsidiary tables is controlled independently, so a new filter on a subsidiary table is in addition to a filter on a higher level.

If you inadvertently enter the filter expression on the wrong row, Open Plan attempts to automatically move the filter expression to the correct row. This will be visible the next time that you display the **Define Link** tab.

To define a temporary filter on a secondary table in a multi-table view

1. Open the multi-table view to which you want to apply a temporary filter.
2. Take one of the following actions:
 - On the **Tools** menu, click **Preferences**.
 - Right-click within the view, and click **Preferences** on the context menu.

Open Plan displays the **Spreadsheet Preferences** dialog box.

3. Click the **Define Link** tab.
4. In the **Filter** field, enter the temporary filter you want to apply, and click **OK**.

Open Plan applies the filter to the secondary table identified in the table column.



These temporary filters are not displayed in the **Filters** dialog box. They are not saved as part of the project. If you save a view while a temporary filter is in effect, Open Plan saves the view with the filter applied.

In addition to using temporary filters in Open Plan views, you can create and use temporary filters in the following circumstances:

- Export scripts
- OLE automation

Sorts

By default, Open Plan displays activities and resources in barchart and spreadsheet views in order of ID. However, you can assign a different sorting sequence to a view so that, for example, activities appear in order of early start dates.

Open Plan provides a number of predefined sorts that are commonly used in project management reports. In addition to these predefined sorts, you can define custom sorts of your own.



If a view is displayed using outlining or subsections, Open Plan sorts the items within the outline or subsection hierarchy.

Default Sort Order Rules

The following rules apply to the default sort order, which is in effect when there is no sort specified. Explicitly sorting on Activity ID will still sort alphabetically.

- The default sort order for all hierarchical fields (activity IDs, resource IDs, and codes) is interpreted numerically, if possible. Therefore, “1.2” is sorted before “1.10.” Character data is sorted alphabetically.
- Mixed character and numeric data is also sorted alphabetically, except that any trailing numeric digits are sorted numerically. For example, “A2” comes before “A10.” Since each component of the name is sorted independently, some data can be numeric and some not.
- IDs with leading zeros are sorted first. For example, “A01” comes before “A1.”

Also, when you have a table based upon a hierarchy, the **Refresh** button on the toolbar is enabled even when no sort or filter is specified.

The rules for the sort order are fundamental to the workings of the automatic numbering and indent/outdent features.



For information on automatic numbering and the indent/outdent features, refer to Chapter 20, “Spreadsheet Views.”



Refresh button

Using Sorts

Issuing the **Sorts** command displays a list of available sorts in the **Sorts** dialog box:

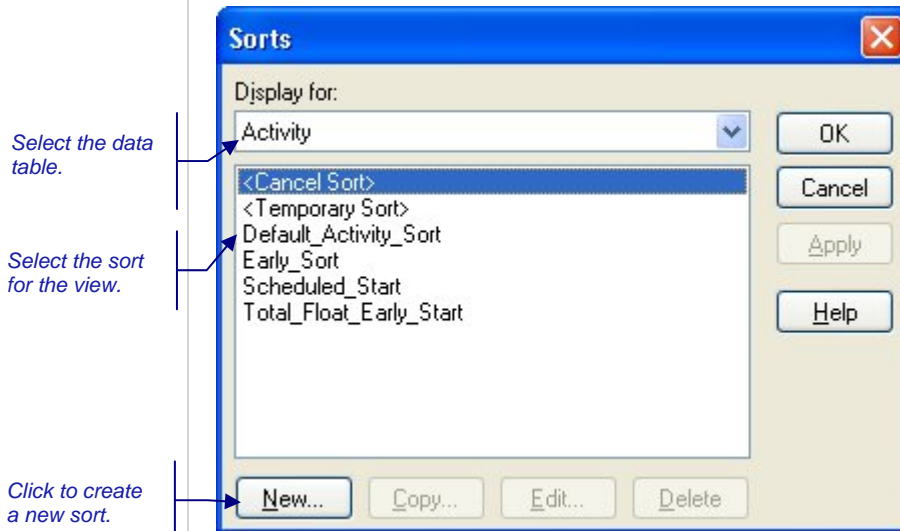

You can use this dialog box to apply an existing sort to the view as well as to cancel the sort currently in effect.

Each view for a project can have a different sort in effect. The name of the sort currently in effect appears in the status bar at the bottom of the Open Plan window:

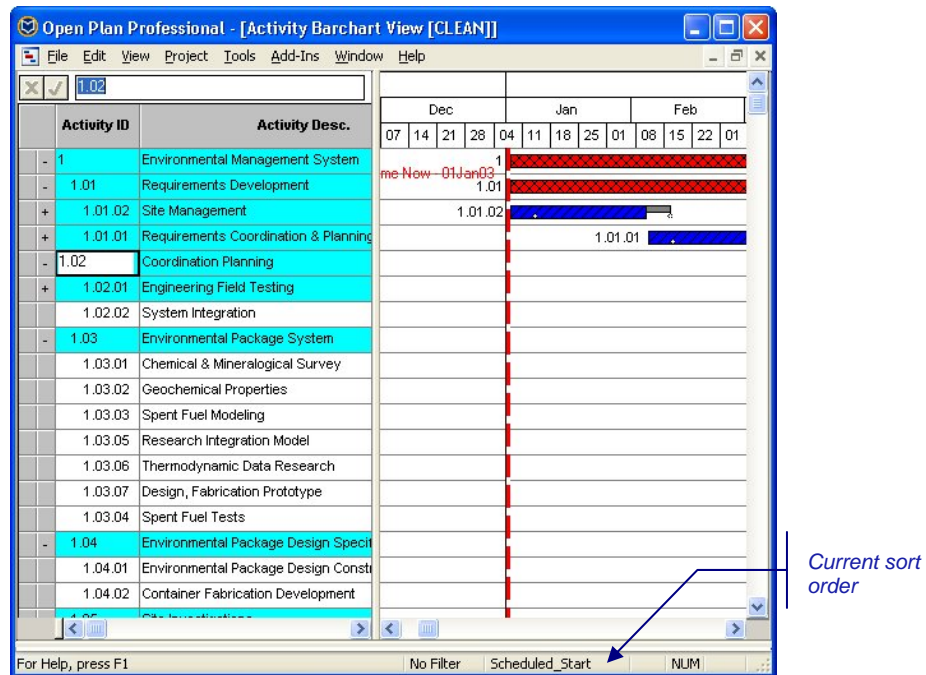

 Refresh button

To reapply the sort (or the filter) without exiting the view, click the **Refresh** button on the toolbar.

 Sorts do not affect the display of activities in a network view.

To apply a sort

1. Take one of the following actions:
 - On the **Tools** menu, click **Sorts**.
 - Right-click within the view, and click **Sorts** on the context menu.
2. From the **Sorts** dialog box, select the sort you want to apply, and click **Close**.

To refresh a sort

1. On the toolbar, click the **Refresh** button.



Refresh button

To cancel a sort

1. Take one of the following actions:
 - On the **Tools** menu, click **Sorts**.
 - Right-click within the view, and click **Sorts** on the context menu.
2. From the **Sorts** dialog box, select **<Cancel sort>**, and click **Close**.

Defining Custom Sorts

You can define custom sort sequences based on data from any activity- or resource-related data table. Custom sorts can also include any calculated fields for those tables.

When you create a new sort, Open Plan displays a dialog box in which you can enter a sort name and indicate the source of the sort fields.

Select a data table for the sort.

Once you have entered a name and selected a data table, Open Plan allows you to define the sort expression using the following dialog box.

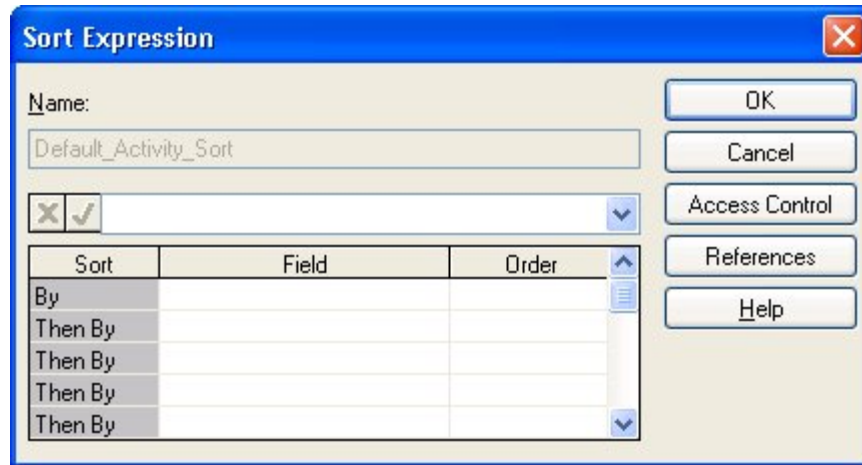

With this dialog box, you can build a sort expression by indicating each sorting field and whether Open Plan should use an ascending or a descending order when sorting activities using that field. You can choose to share this item with other users.

You can define sort expressions based on substrings of a text field (for example, the activity description) by creating a calculated field containing the substring and then including the calculated field in the sort expression.

You may use the **Access Control** option to grant rights to other users in the data source to use the expression.

You may use the **References** option to see a list of items that use the sort. This list of items includes the file type, name of the project or file, description, and owner.



For information about creating calculated fields, refer to the “Defining Calculated Fields” section in this chapter.

To add a sort

1. On the **Tools** menu, click **Sorts**.
2. On the **Sorts** dialog box, click **New**.
3. In the **New Sort** dialog box, enter a name, and select a source data table for the new sort expression.
4. Click **OK**.
5. In the **Sort Expression** dialog box, define the sort expression.
6. When the information for the expression is complete, click **OK** to return to the **Sorts** dialog box.

To edit a sort

1. On the **Tools** menu, click **Sorts**.
2. From the **Sorts** dialog box, select the sort you want to change, and click **Edit**.
3. In the **Sort Expression** dialog box, update the sort expression.
4. When the information for the expression is complete, click **OK** to return to the **Sorts** dialog box.

To copy a sort

1. On the **Tools** menu, click **Sorts**.
2. From the **Sorts** dialog box , select the sort you want to copy, and click **Copy**.
3. In the **Sort Expression** dialog box, enter a new name for the sort.
4. When the information for the new expression is complete, click **OK** to return to the **Sorts** dialog box.

To delete a sort

1. On the **Tools** menu, click **Sorts**.
2. From the **Sorts** dialog box , select the sort you want to delete, and click **Delete**.
3. When Open Plan asks you to confirm the deletion, click **Yes**.

Temporary Sorts

In addition to creating permanent sorts, you can also create temporary sorts. Temporary sorts are available only in the view in which they are defined and valid until they are superceded by another sort. You cannot make these temporary filters available to other projects or users.

You can create temporary sorts in the following ways:

- By clicking the column headings in a spreadsheet view if the **Click to Sort** option is enabled. Using this method you can sort the data in the spreadsheet based on either a single column or on multiple columns.



For more information on the **Click to Sort** option, refer to the "Click to Sort" section later in this chapter.

- By selecting **<Temporary Sort>** from the **Sorts** dialog box to display the **Temporary Sort Expression** dialog box.

The temporary sort created in the two manners described above can be applied to a primary table. In a multi-table spreadsheet view, you have the option of applying a sort to a secondary table using the **Define Link** tab of the **Spreadsheet Preferences** dialog box or by clicking the column headings as described above.



In a multi-table view, the primary table is the main table upon which the view is based. The secondary table is the linked table.

While you can simply type the sort expression in the text box of the **Temporary Sort Expression** dialog box, you can also use the **Fields** button to display a dialog box that you can use as an aid in building the sort expression.

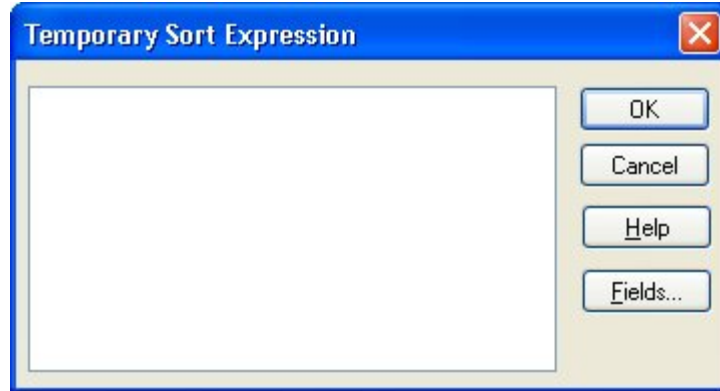

Open Plan temporary sorts are formed using the following syntax:

```
<sort_field1>,<sort order>|<sort_field2>,<sort order>|...
```

where:

- Each of the **<sort_fieldx>** values is either the name of an existing field on the appropriate table or the definition of a calculated field for that table.
- The **<sort order>** indicates an ascending (**0**) or a descending (**1**) sort.
- The piping symbol (|) separates the sorts you create.

The following is an example:

```
ORIG_DUR,0|ACT_ID,1
```

Would first sort ascending the original duration field and then within that would sort descending the activity ID field.

In addition to using temporary sorts in Open Plan views, you can also use temporary sorts in the following circumstances:

- Export scripts
- OLE automation

To define a temporary sort using the Temporary Sort Expression dialog box

1. Display the view to which you want to apply the temporary sort.
2. On the **Tools** menu, click **Sorts**.
Open Plan displays the **Sorts** dialog box.
3. Display the **Temporary Sort Expression** dialog box by taking one of the following actions:
 - Double-click <Temporary Sort>.
 - Select <Temporary Sort>, and click Edit.
4. Enter the temporary sort in the text box.





You can use the **Fields** and **Functions** buttons as an aid in building your sort expressions.

5. Click **OK**.

Temporary Sort on a Secondary Table

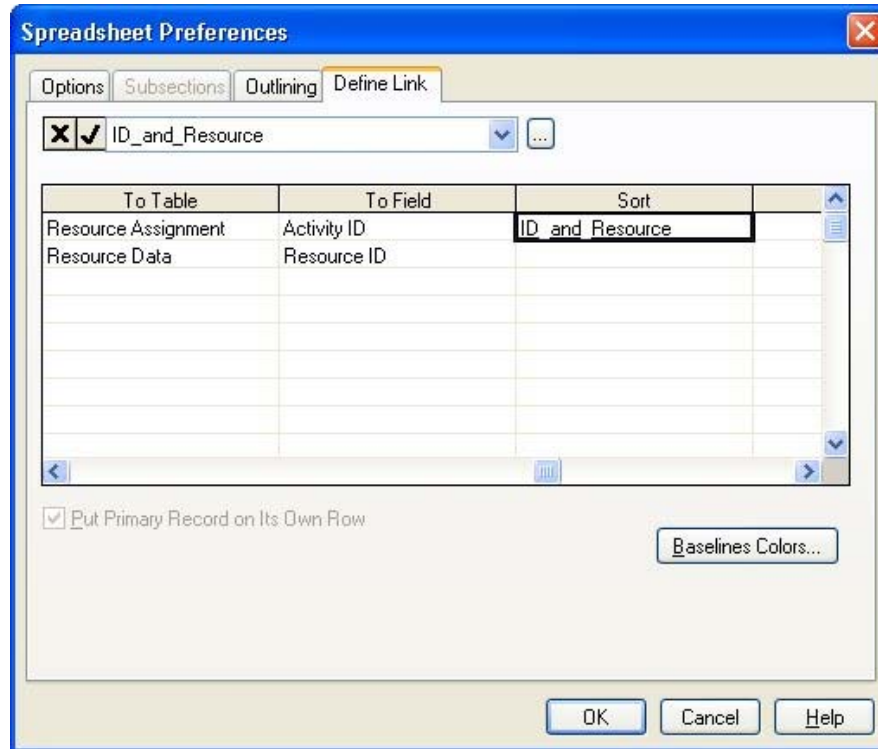
You can apply a temporary sort to a secondary table in the multi-table spreadsheet view by using the **Define Link** tab of the **Spreadsheet Preferences** dialog box:



 The **Define Link** tab applies to the Professional edition of Open Plan only.

The sort order for data from all subsidiary tables is controlled independently, so a new sort on a subsidiary table is in addition to a sort on a higher level.

 You can also create a temporary sort for a secondary table by applying the **Click to Sort** feature to column headings of the secondary table. The **Click to Sort** feature is discussed later in this chapter.

If you inadvertently enter the sort expression on the wrong row, Open Plan attempts to automatically move the sort expression to the correct row. This will be visible the next time that you display the **Define Link** tab.

To define a temporary sort on a secondary table in a multi-table view

 When you sort columns based on a secondary table, using the **Click to Sort** option records the temporary sort in the **Sort** column of the **Define Link** tab of the **Spreadsheet Preferences** dialog box.

1. Open the multi-table spreadsheet view to which you want to apply a temporary sort.
2. Take one of the following actions:

- On the **Tools** menu, click **Preferences**.
 - Right-click an empty area of the view, and click **Preferences** on the context menu.
3. On the **Spreadsheet Preferences** dialog box, click the **Define Link** tab.
 4. In the **Sorts** field, enter the temporary sort you want to apply, and click **OK**.

Open Plan applies the sort to the secondary table identified in the **To Table** column.



These temporary sorts are not displayed in the **Sorts** dialog box. They are not saved as part of the project. If you save the view while a temporary sort is in effect, Open Plan saves the view with the sort applied.

Click to Sort

In addition to the temporary sort, the spreadsheet and barchart views allow column sorting by clicking the column headings.

With the **Click to Sort** option enabled, you can click the column heading on which you want to base the sort. Clicking the same column heading again will toggle the sort operation between ascending and descending order.

To sort the data based on multiple columns, click the first column heading on which you want to sort. For non-adjacent columns, **Ctrl-click** additional columns until you have defined the entire sort expression. For adjacent columns, **Shift-click** additional columns until you have defined the entire sort expression.



When you sort columns based on a primary table in multi-table views, using the **Click to Sort** option records the temporary sort on the **Temporary Sort Expression** dialog box. If you sort the spreadsheet based on a secondary table, the sort expression is reflected in the **Sort** column on the **Define Link** tab of the **Spreadsheet Preferences** dialog box.

To enable the Click to Sort option

1. Take one of the following actions:
 - Right-click a column heading, and click **Click to Sort** on the context menu.
 - On the **View** menu, point to **Spreadsheet**, and click **Click to Sort** on the submenu.

To disable the Click to Sort option

1. Take one of the following actions:
 - Right-click a column heading, and click the **Click to Sort** option on the context menu to clear it.
 - On the **View** menu, point to **Spreadsheet**, and click **Click to Sort** on the submenu to clear it.

Calculated Fields

In Open Plan, the data fields displayed in a view are typically one of three types:

- Normal data entry fields — for example, an activity ID or description that can be updated by the user at any time
- Fields generated by Open Plan processes — for example, the early start and finish dates calculated by time analysis.
- Calculated fields defined by the user.

User-defined calculated fields allow you to calculate and display data not stored in the standard versions of the project database tables. With calculated fields, you can extend the flexibility of any view by displaying data that is the result of a custom calculation. Once defined, a calculated field can be treated as any other type of field. For example, you can display that field as a column in a spreadsheet view or in an activity box, just as you can any standard field. You can also include calculated fields in custom filter and sort expressions.

Calculated fields are available for display in both Professional and Desktop editions of Open Plan. To define a calculated field, however, you must use the Professional edition of Open Plan.



Open Plan does not store the results of calculated fields in the project database. Only the definition of the calculation is saved — the results are recalculated each time the field is required for display. Third-party applications that query the database cannot, therefore, access the results of calculated fields. You can, however, use the global edit feature (described later in this chapter) to place the contents of a calculated field into a user-defined field.

Defining Calculated Fields

If you are using the Professional edition of Open Plan, you can use the **Calculated Fields** command from the **Tools** menu to define a new calculated field at any time. When you define a new calculated field, Open Plan displays a dialog box in which you can enter a name for the field, the data table to which you want to associate the field, and the type of result produced by the field.

You can define a new calculated field to produce one of the following types of results:

- **Character** — Returns a character string to the calculated field
- **Date** — Returns a date to the calculated field

- **Decimal** — Returns a decimal number (for example, 7.89) to the calculated field
- **Duration** — Returns a duration to the calculated field
- **Finish Date** — Returns an activity finish date to the calculated field
- **Integer** — Returns a whole number to the calculated field
- **Logical** — Returns True or False to the calculated field

Once you provide a name, data table association, and result type for the calculated field, Open Plan allows you to enter the expression for the field.

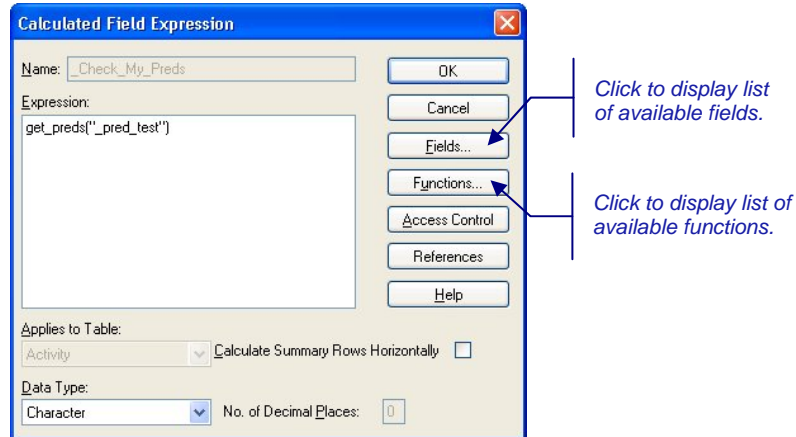

Use the **Fields** and **Functions** commands to display lists of items that you can insert into the expression you are editing.

The **Calculate Summary Rows Horizontally** option applies to calculated fields appearing in summary rows of spreadsheets using subsectioning. If you select this option, Open Plan calculates the value of the field based on the values of the summarized row, effectively disabling the rolling up of the field. If you leave the option unselected, Open Plan simply rolls up the values appearing in the column. For example, assume that you have defined a calculated field that compares two activity dates. When this calculated field appears in a summary row, it is likely that you want to display a value based on summarized dates rather than one that is the simple aggregation of the calculated values appearing in the column.

You can also change the table and data type assignment for the expression. For expressions that result in decimal data types, you can specify the number of decimal places in the result.



For a complete description of the operators and functions available for calculated fields, refer to Chapter 2, “Defining Calculated Fields,” in the *Deltek Open Plan Developer’s Guide*.

You can define calculated fields for both project and resource files. By default, Open Plan stores the calculated field with the project or resource file that is open when you define the field. (Open Plan may also store the field with the current view if the field is used by the view.)

Select the **Access Control** option to grant rights to other users in the data source to use the expression.

Select the **References** option to display the References dialog box, which has a list of items that use the calculated field. This list of items includes the file type, name of the project or file, description, and owner.

To add a calculated field

1. On the **Tools** menu, click **Calculated Fields**.
2. On the **Calculated Fields** dialog box, click **New**.
3. Enter the following information:
 - Field name
 - The data table to which you want to associate the field
 - The data type of the field



The data type of the field must match the result produced by the calculated field expression.

4. When the information for the field is complete, click **OK**.
5. In the **Calculated Field Expression** dialog box, enter the expression for the calculation.
To see a list of fields for the expression, click **Fields**.
To see a list of functions for the expression, click **Functions**.
6. When the expression is complete, click **OK** to return to the **Calculated Fields** dialog box.

To edit a calculated field

1. On the **Tools** menu, click **Calculated Fields**.
2. Select the calculated field you want to change, and click **Edit**.
If you do not see the appropriate calculated field listed in the dialog box, use the **Display For** list to select another data table.
3. In the **Calculated Field Expression** dialog box, update the expression for the field.
4. When the information for the expression is complete, click **OK** to return to the **Calculated Fields** dialog box.

To copy a calculated field

1. On the **Tools** menu, click **Calculated Fields**.
2. Select the calculated field you want to copy, and click **Copy**.
If you do not see the appropriate calculated field listed in the dialog box, use the **Display For** list to select another data table.
3. In the **Calculated Field Expression** dialog box, enter a new name for the field.
4. When the information for the new expression is complete, click **OK** to return to the **Calculated Fields** dialog box.

To delete a calculated field

1. On the **Tools** menu, click **Calculated Fields**.
2. Select the calculated field you want to delete, and click **Delete**.
If you do not see the appropriate calculated field listed in the dialog box, use the **Display For** list to select another data table.
3. When Open Plan asks you to confirm the deletion, click **Yes**.

Temporary Calculated Fields

In addition to allowing you to name and save calculated fields for future use, Open Plan allows you to create and use temporary calculated fields in the following circumstances:

- Export scripts
- Spreadsheet **Add**, **Insert**, and **Edit Column** dialog boxes
- Multi-table define links
- When defining the box layouts for the network and hierarchy views
- When defining box attributes for the network view
- OLE automation



These temporary calculated fields are not displayed in the **Calculated Fields** dialog box. They are not saved as part of the project. If you save the view while a temporary calculated field is in effect, Open Plan saves the view with the definition applied.

To define a temporary calculated field in a network view

1. Display the network view to which you want to apply the temporary calculated field.
2. Take one of the following actions:
 - On the **Tools** menu, click **Preferences**.
 - Right-click an empty area of the view, and click **Preferences** on the context menu.
3. On the **Preferences** dialog box, click the **Box Attribute** or the **Box Layout** tab.
4. Enter the temporary calculated field in the **Criterion** or **Field** column., and click **OK**.

Open Plan displays the results of the calculated field in the network view.

To define a temporary calculated field in a spreadsheet view

1. Display the spreadsheet view to which you want to apply the temporary calculated field.
2. Right-click the column heading, and click **Add**, **Insert**, or **Edit** column.
Open Plan displays the appropriate **Column** dialog box.

3. Enter the calculated field in the **Field Name** field and a column title in the **Title** field, and click **OK**.

Open Plan displays the results of the calculated field in the selected column.

Rollup

The Rollup utility provides the ability to perform a roll-up of date and numeric fields selected by the user. Rollups may be defined for Activities, Resources, and Codes.

Selecting **Rollup** from the **Tools** menu displays the following dialog box:

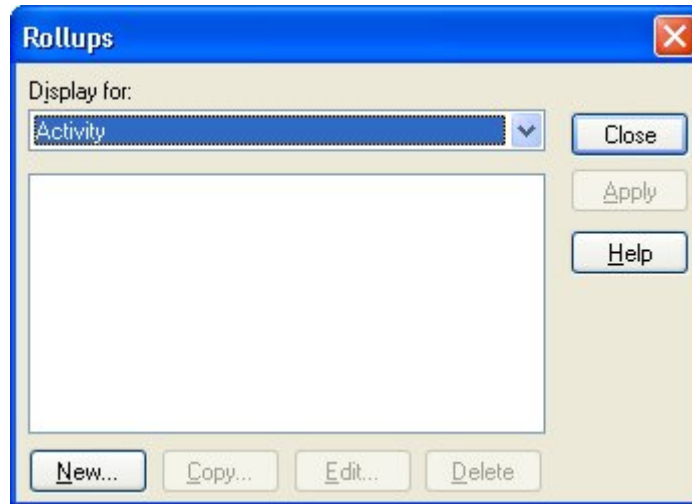

This dialog box allows you to perform a rollup of selected numeric and date fields for Activities, Resources, and Codes. For numeric fields, the parent object is the sum of its children. For date fields, the Start date of the parent object is the earliest date of its children, and the Finish date is the latest date of its children.



If any of the children have a blank finish date, a blank finish date is rolled up to the parent.

The **Display for** field allows you to select the table that contains the rollup definition you want to use.

When a table is selected, the dialog box is populated with all of the rollup definitions that have been created for that table. Selecting a rollup definition and clicking **Apply** performs the rollup for the current file.

For numeric fields, the parent object is the sum of its children. For date fields, the **Start** date of the parent object is the earliest date of its children, and the **Finish** date is the latest date of its children.

If any of the children have a blank finish date, a blank finish date is rolled up to the parent.

When you click **New** or select a rollup definition and click **Copy** or **Edit**, the **Rollup Definition** dialog box is displayed:

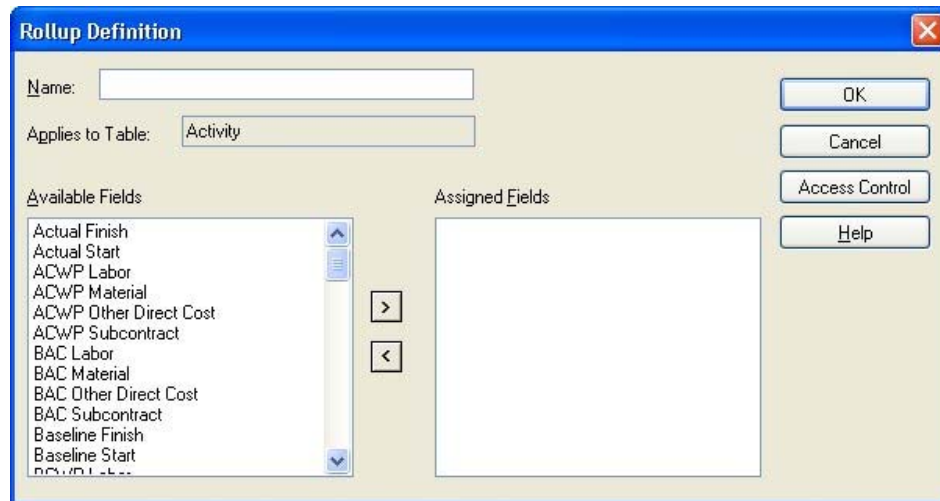

The **Rollup Definition** dialog box displays the following controls:

- **Name** — If you are creating a new definition, this field will display blank, allowing you to add a name. If you are copying an existing definition, this field will be populated with the name, preceded by *copy_ name*. You can either accept the new name or replace it with a different name. If you are editing a definition, the name will display dimmed, and cannot be changed.
- **Applies to Table** — This field is populated with the table name that was previously selected, and cannot be changed on this dialog box.
- **Available Fields** — This lists all date and numeric fields created for the selected table. To apply a field to the rollup you are defining, double-click the edit name or click the > button to move the listed edit to the **Assigned Fields** window.



To move the entire list, select the list by clicking the first name, then depress the **Shift** key and click the last name in the list, then click the > button. To select a random group from the list to move, press and hold the **CTRL** key and click the mouse pointer on the items to be moved to highlight, then click the > button.

- **Assigned Fields**— This lists the fields the rollup definition will use. You can also remove any or all of the items in the **Assigned Fields** list by either double-clicking the item name, or clicking it to highlight and then clicking the < button. This will move the selected item or items to the **Available Fields** list.
- **Access Control** — Select this option to grant rights to other users in the data source to use the definition.

After you have created or edited rollup definitions, the display returns to the **Rollups** dialog box.

To execute a rollup for the current file

1. Select a rollup definition from the **Rollups** dialog box.
2. Click **Apply**.

Group Process Rollups

You can also perform a rollup in **Batch Mode**. This allows you to use a rollup definition for multiple projects at one time. To use a rollup definition in **Batch Mode**, select more than one project from the **Details** pane of the Open Plan Explorer, and click **Rollup** on the **Tools** menu. The **Rollups [Batch Mode]** dialog box will be displayed. Select the rollup definition to use, and click **Apply**.

If a project is closed, Open Plan will open it in **Exclusive** mode, perform the process, save the changes, and then close the project. If a project cannot be opened in **Exclusive** mode (because another user has it open in **Exclusive** or **Shared** mode), it will be skipped.

If you have a project open when the batch process is run, rollup will be performed on the project, but the changes will not be saved and the project will remain open. You must manually save the changes yourself.

Global Edit

With the **Global Edit** utility, you can modify multiple activity, resource description, or resource assignment records with a single operation. Using the global edit utility you can, for example, increase all the durations in a project by 25% or change all the assignments for a specific resource. Global edit operations can modify all the records in a file or selected records based on a filter expression.

When you click **Global Edit** on the **Tools** menu, Open Plan responds with the following dialog box:

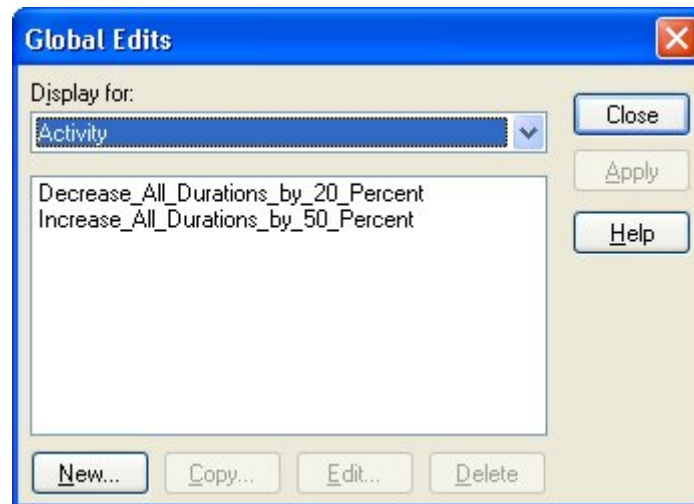

This dialog box displays a list of currently available global edits. Since they change all instances of the data, global edits may be applied regardless of whether or not any specific view is open.

The **Display For** field contains a list that segregates the global edits by type of data. For example, if you select **Project** from the list, the global edits that are displayed are project related.

You can display or apply a global edit using either the Professional or the Desktop edition of Open Plan. Defining or updating a global edit, however, requires the use of Professional edition of Open Plan.

To apply a global edit

1. Open the project or resource file to which you want to apply the global edit.
2. On the **Tools** menu, click **Global Edit**
3. Select the global edit you want to apply.

To display the expression for the edit, click **Edit** (if you are using the Professional edition of Open Plan) or **Display** (if you are using the Desktop edition of Open Plan).

4. Click **Apply**.

Defining Global Edits

If you are using the Professional edition of Open Plan, you can define a new global edit at any time.

You can define global edits for both project and resource files. By default, Open Plan stores the edit expression with the project or resource file that is open when you define the field. When you define a new global edit, Open Plan displays the following dialog box:

You can use the following controls to define the global edit:

- **Name** — If you have a project or resource file open, the default value in this field is **<temporary>**. By leaving this default value, you can create global edits without saving them.



In order to save a global edit, you must change the default **<temporary>** value to a different name. When you then save the global edit, the name you entered is displayed on the **Global Edits** dialog box.

If you have accessed this dialog box without first opening a project or resource file, the **Name** field is blank since there is no target for a temporary sort.

- **Applies to Table** — Controls the data table to which the new global edit applies. The choices from which you can select depend on whether you are creating a global edit for a project or for a resource file:

Project	Resource
Activity	Resource Availability
Relationship	Resource Description
Resource Assignment	Resource Escalation
Resource Cost	Summary Usage

Project	Resource
Resource Usage	
Risk Detail	
Subproject	

- **Replace Values in** — Controls the field of the data table to which the global edit applies.
- **Of Type** — Displays which of the following types of data is stored in the selected field of the data table:
 - Date
 - Decimal
 - Duration
 - Finish Date
 - Integer
 - Character
 - Logical
 - Enumerated values



For more information on enumerated field values, refer to the **Help** for this topic.

- **With Expression** — Controls the expression that will replace the data in the selected data table field. The expression must create data of the same type as the data it will replace. For example, if the global edit replaces a date, the global expression must also create a date.

An expression defining a global edit can include the following elements:

- Character operators
- Constants
- Duration operators
- Field names
- Functions
- Logical operators
- Mathematical operators
- Calculated fields
- Relational operators



For more information on the above elements, refer to the online **Help** for this topic.

- **Matching Filter** — The **ellipsis** button at the right edge of this field displays the **Filters** dialog box that you can use to apply a filter to the global edit. In this way, you can limit the records that will be affected by the global edit.
- **Access Control** — Select this option to grant rights to other users in the data source to use the definition.
- **References** — Displays the **References** dialog box, which has a list of items that use the global edit. This list of items includes the file type, name of the project or file, description, and owner.
- **Fields** — Displays a dialog box where you can select a field to include in the expression.
- **Functions** — Displays a list of available functions.
- **Values** — Displays the **Select a Value** dialog box that you can use to select a value to include in the global edit.

The expression for a global edit can use the same set of functions, operators, and field names that you use when creating calculated fields.



For more information, refer to Chapter 2, “Defining Calculated Fields,” in the *Delttek Open Plan Developer’s Guide*.

The following table shows some simple examples of operations you can perform on the original durations of activities in a project:

Expression	Result
ORIG_DUR- 1d	Subtract one day from each duration
ORIG_DUR*1.25	Increase durations by 25%
SCHED_DUR	Set original durations to scheduled durations

You can also specify a filter to limit the effect of the operation to a selected group of records.

To add a global edit

1. On the **Tools** menu, click **Global Edit**.
2. On the **Global Edits** dialog box, click **New**.
3. Enter the following information for the operation:
 - The name of the edit
 - The data table and field to modify
 - The expression for the operation
 - An optional filter for the operation

To see a list of fields for the expression, click **Fields**.

To see a list of functions for the expression, click **Functions**.

4. When the definition is complete, click **OK** to return to the **Global Edits** dialog box.



To create a new filter for the edit from the **Global Edit Definition** dialog box, click the **ellipsis** button displayed next to the filter text box. For information about creating a filter, refer to the “Defining Filter Expressions” section in this chapter.

To apply a global edit without saving the expression

1. Open the project or resource file for which you want to apply the temporary global edit.
2. On the **Tools** menu, click **Global Edit**
3. On the **Global Edits** dialog box, click **New**.
4. Enter the information for the expression, but leave the name as **<temporary>**.
5. When the expression is complete, click **Apply**.

To update a global edit definition

1. On the **Tools** menu, click **Global Edit**.
2. Select the global edit you want to change, and click **Edit**.
3. In the **Global Edit Definition** dialog box, update the definition.
4. When the information for the new edit is complete, click **OK** to return to the **Global Edits** dialog box.

To copy a global edit

1. On the **Tools** menu, click **Global Edit**.
2. Select the global edit you want to copy, and click **Copy**.
3. In the **Global Edit Definition** dialog box, enter a new name for the definition.
4. When the information for the new edit is complete, click **OK** to return to the **Global Edits** dialog box.

To delete a global edit

1. On the **Tools** menu, click **Global Edit**.
2. Select the global edit you want to delete, and click **Delete**.
3. When Open Plan asks you to confirm the deletion, click **Yes**.

Batch Global Edits

A global edit allows you to modify multiple activities or resources with a single operation. The **Batch Global Edit** dialog box allows you to create groups of global edits (batches) that can be applied to a file in a single operation. When you click **Batch Global Edit** on the **Tools** menu, Open Plan responds with the following dialog box:

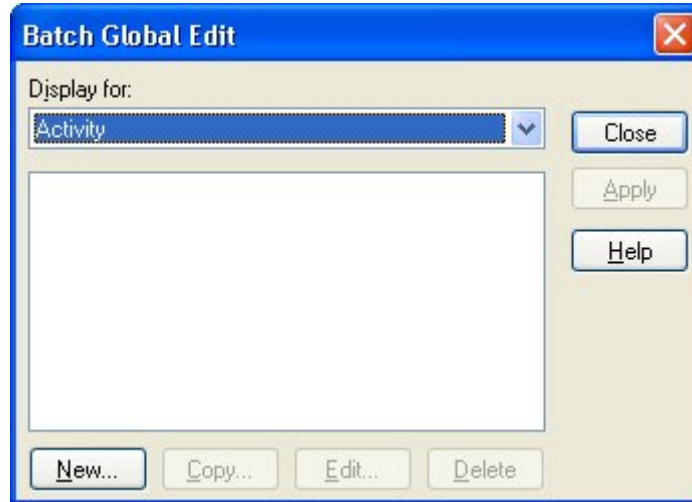

The **Batch Global Edit** dialog box displays a list of currently available definitions. The **Display For** field contains a list that segregates the batches by type of data. For example, if you select **Activity** from the list, the batches that are displayed are activity related.



In the Desktop edition of Open Plan, a **Display** button provides access to a dialog box where you can view the batch global edit definition.

When you click **New** or select a batch and click **Copy** or **Edit**, the **Batch Global Edit Definition** dialog box is displayed:

You can use this dialog box to select the global edits that the batch will use as well as the order in which the global edits are executed.

The **Batch Global Edit Definition** dialog box displays the following controls:

- **Name**—If you are creating a new definition, this field will display blank, allowing you to add a name. If you are copying an existing definition, this field will be populated with the name, preceded by *copy_ name of edit*. You can either accept the new name or replace it with a different name. If you are editing a definition, the name will display dimmed, and cannot be changed.
- **Applies to Table**—This field is populated with the table name that was previously selected, and cannot be changed on this dialog box.
- **Available Global Edits**—This field initially lists all global edits created for the selected table. To apply a global edit to the batch global edit you are defining, double-click the edit name or click the > button to move the listed edit to the **Assigned Global Edits** field.



To move the entire list, select the list by clicking the first name, then depress the **Shift** key and click the last name in the list, then click the > button. To select a random group from the list to move, press and hold the **CTRL** key and click the mouse pointer on the items to be moved to highlight, then click the > button.

- **Assigned Global Edits**— This field lists the global edits the batch definition will be used, and the order in which the global edits will be executed. To change the order of the list, select the item to be moved and click the up or down arrows adjacent to the list.

You can also remove any or all of the items in the **Assigned Global Edits** list by either double-clicking the item name, or clicking it to highlight and then clicking the < button. This will move the selected item or items to the **Available Global Edits** list.

- **Global Edits** — Clicking this button opens the **Global Edits** dialog box. You would use this option if the global edit you want to include in the batch definition does not exist or if you need to modify an existing global edit before including it in the batch.
- **Access Control** — Select this option to grant rights to other users in the data source to use the definition.

To create a batch global edit definition:

1. From the **Tools** menu, click **Batch Global Edit**.
2. From the **Display for** list on **Batch Global Edit** dialog box, select the table to which the batch global edit applies.
3. Click **New**.
4. From the **Available Global Edits** lists, select the global edits to include in the batch definition, and click the right arrow button.
5. You can select multiple global edits to include at once by clicking **Ctrl+ or Shift +** and selecting the global edits you want to include.
6. If the global edit you want to include is not listed, click the **Global Edits** button to display the **Global Edits** dialog box that you can use to create the appropriate global edit.
7. In the **Assigned Global Edits** list, use the up and down arrow buttons to determine the order in which the global edits are to be executed.
8. If you wish to share the batch definition with other users, select the **Share this Item with Others** option.
9. When you are finished defining the batch, click **OK**.



When a batch is applied, it is first reconciled to verify all referenced global edits exist. If missing global edits are detected, a message is displayed to let you decide if you want to continue to apply the batch or not. If you choose to continue, the batch is applied and the missing global edits are removed from the definition.

User Defined Fields

Open Plan allows you to create and use data fields that are not included in the product as delivered by Deltek. Because these fields can be used by most tables and are available in any view where you can select fields for display, they provide a great deal of flexibility and customizability.

At the same time, it is important to note that while user defined fields can be created very quickly, they are not the only way in which data fields can be added to the Open Plan database. It is also possible to add fields to the Open Plan tables. The question of which is the better avenue to take depends on how often the additional fields will be used:

- If the fields to be added will be used infrequently, user defined fields provide a quick and easy solution. However, because user defined fields may be used by many projects, they require identifying information in addition to their data. This means that there is much more information that must be processed each time the field is required. If the field is used frequently, performance may be adversely affected.
- If the additional field will be used frequently, the best answer may be to modify the structure of the affected Open Plan table. While this will take more effort than creating a user defined field, the improved performance may be significant. You may want to consult with your database administrator if you want to modify the structure of an Open Plan table.



For more information about the Open Plan data structures, refer to Chapter 17, "Standard File Structures," in the *Deltek Open Plan Developer's Guide*.

Clicking **User Defined Fields** on the **Tools** menu displays the following dialog box:

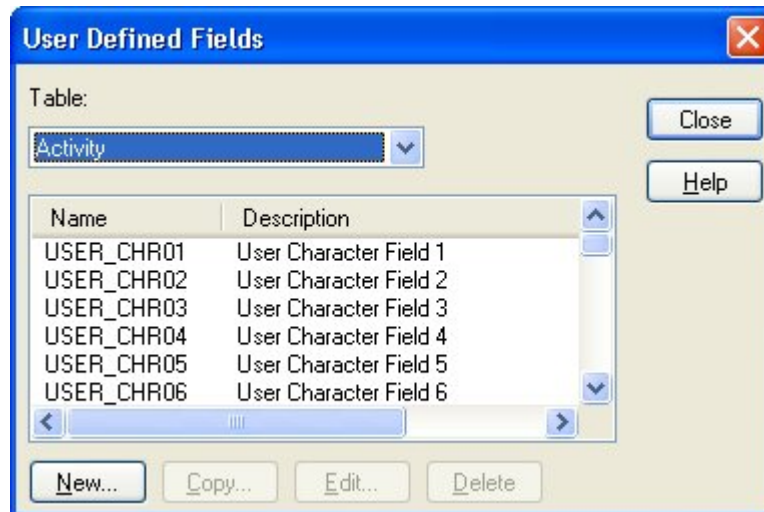

This dialog box displays a list of user defined fields that are available for the selected data table.

The **Table** field at the top of the dialog box allows you to select the data table to which the user defined field applies.



Data is not saved by Open Plan when the data is entered on interproject links for user defined fields created on the Relationship table.

Creating a User Defined Field

To create a user defined field, click **New** on the **User Defined Fields** dialog box to display the following:

This dialog box contains the following controls:

- **Name** — The name of the new user defined field. This is the internal name that Open Plan associates with the user defined field.
- **Data Type** — You can select from the following data types:
 - Character
 - Date
 - Finish Date
 - Decimal
 - Duration

In addition to specifying the type of data that you will be able to enter in the new user defined field, the data type also specifies the length of the field. For example, if you select **Character**, Open Plan creates the user defined field with a length of 60.

- **Description** — You can use this field to assign a longer, more meaningful description to the user defined field.
- **Also Create Field for Baseline** — This option is enabled only if you are creating a user defined field for the Activity table. If you select this option, Open Plan adds the new user defined field to the Baseline table.
- **Link Field to Lookup Table** — Selecting this option will link the field to a Lookup Table by selecting from the following list of options:
 - **Lookup Table Type** — Select the type of Lookup Table from the list.

- **Lookup Field Name** — Once the type is selected, you can select the specific field.
- **Lookup Table Name** — This option is available if you previously selected a Resource or Code Table type.

To create a user defined field

1. On the **Tools** menu, click **User Defined Fields**.
2. On the **User Defined Fields** dialog box, click **New**.
3. Enter the information for the new field, and click **OK**.

Open Plan adds the user defined field to the appropriate data table and includes it in the list displayed on the **User Defined Fields** dialog box.

Copying a User Defined Field

You can copy any existing user defined field by selecting a field and clicking **Copy** on the **User Defined Field** dialog box to display the following:

Using this dialog, you can change the **Name**, **Data Type**, and **Description** for the copy of the user defined field. You can also select or clear the **Also Create Field for Baseline** option.

To copy a user defined field

1. On the **Tools** menu, click **User Defined Fields**.
2. From the list on the **User Defined Fields** dialog box, select the field to copy.
3. Enter the information for the copy, and click **OK**.

Open Plan adds the user defined field copy to the appropriate data table and includes it in the list displayed on the **User Defined Fields** dialog box.

Editing a User Defined Field

You can edit the description of an existing user defined field using the following dialog box:

To edit an existing user defined field

1. On the **Tools** menu, click **User Defined Fields**.
2. From the list on the **User Defined Fields** dialog box, select the field to edit.
3. Enter a new description , and click **OK**.

Open Plan adds the user defined field copy to the appropriate data table and includes it in the list displayed on the **User Defined Fields** dialog box.

Deleting a User Defined Field

Provided you have the appropriate rights to it, you can delete a user defined field from the **User Defined Fields** dialog box.

To delete a user defined field

1. On the **Tools** menu, click **User Defined Fields**.
2. From the list on the **User Defined Fields** dialog box, select the field to delete.
3. Click **Delete**.
4. When Open Plan asks for confirmation of the delete, click **Yes**.

Spread Curves

Spread curves allow you to define the manner in which a resource assignment is distributed over the duration of an activity. When assigning a resource to an activity, you can use the **Curve** field on the **Resources** tab of the **Activity Details** dialog box to select a predefined spread curve.

When you click **Spread Curve** on the **Tools** menu, Open Plan displays the following dialog box:

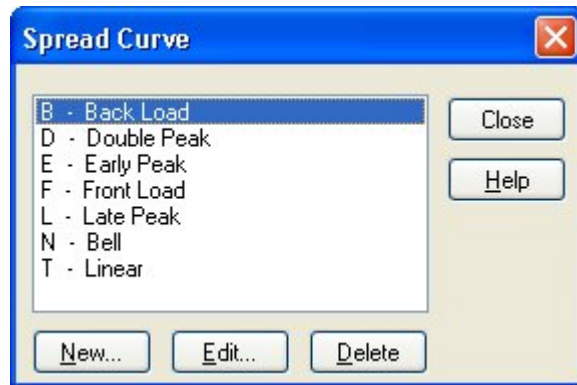

This dialog box lists the spread curves defined for Open Plan. Using this dialog box, you can create a new spread curve, edit a spread curve, or delete a spread curve.

Clicking **New** on the **Spread Curve** dialog box displays the **New Spread Curve** dialog box:

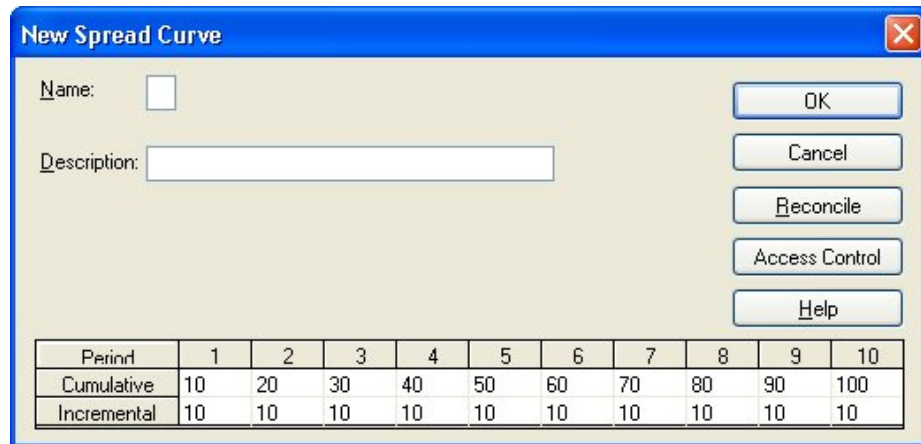

This dialog box features the following controls:

- Name** — Open Plan uses the (single) character entered in this field to identify the spread curve.

If you enter a character that is already in use for another spread curve, Open Plan issues a warning when you click **OK**.
- Description** — This field allows you to specify a more descriptive name for the spread curve. Once defined, the spread curve is identified by both its Name and its Description.

 You cannot leave this field blank. You must enter a description for the spread curve.

- **Cumulative** — As you enter values in the grid, Open Plan recalculates the values and displays the current total in column 10 of the **Cumulative** row.
- **Incremental** — The values in the **Incremental** row allow you to define the percentage to be applied to each specific period.
- **Reconcile** — If you click this button, Open Plan ensures that the value in column 10 of the **Cumulative** row equals 100%. If necessary, Open Plan redistributes the values in the remaining cells in such a manner as to honor your inputs to the extent that it is possible.

When you select an existing spread curve from the Spread Curve dialog box and click Edit, Open Plan displays the Edit Spread Curve dialog box:

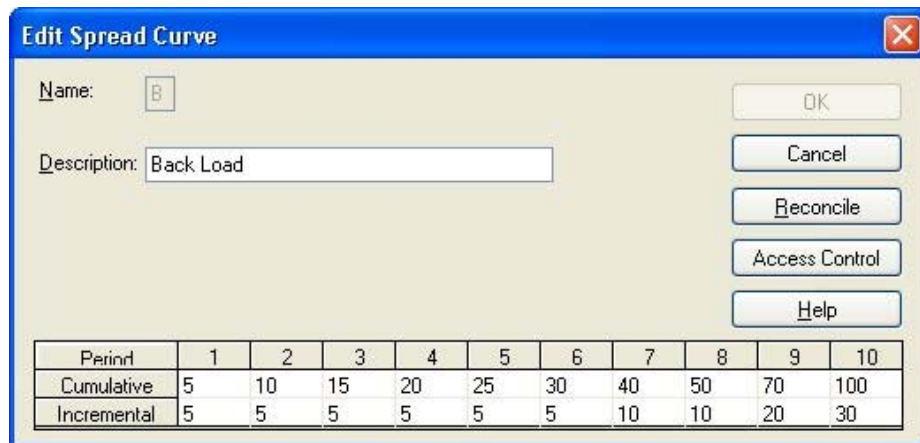

Period	1	2	3	4	5	6	7	8	9	10
Cumulative	5	10	15	20	25	30	40	50	70	100
Incremental	5	5	5	5	5	5	10	10	20	30

This dialog box is similar to the **New Spread Curve** dialog box except that the **Name** field is disabled. You can edit only the description and percentage values in the **Cumulative** and **Incremental** rows. Select the **Access Control** option to grant rights to other users in the data source to use the curve.

 Modifying or deleting a spread curve that is in use by another project will affect the project the next time resource scheduling is performed or a baseline is updated.

To create a new spread curve

1. On the **Tools** menu, click **Spread Curve**.
2. On the **Spread Curve** dialog box, click **New**.
3. In the **Name** field of the **New Spread Curve** dialog box, enter a single character to serve as the name.
4. In the **Description** field, enter a longer description for the spread curve.
5. In the grid at the bottom of the dialog box, enter the appropriate values in any combination of cells in the **Cumulative** and **Incremental** rows.
The total in the **Cumulative** row is displayed in column 10. This value must equal 100%.
6. Click **Reconcile** to ensure that the values in each column of the Cumulative row are correct.

7. Click **OK**.

To edit a spread curve

1. On the **Tools** menu, click **Spread Curve**.
2. From the **Spread Curve** dialog box, select the spread curve to edit.
3. Click **Edit**.
4. In the **Edit Spread Curve** dialog box, enter a new description and percentage values as desired.

The total in the **Cumulative** row is displayed in column 10. This value must equal 100%.

5. Click **Reconcile** to ensure that the values in each column of the Cumulative row are correct.
6. Click **OK**.

To delete a spread curve

1. On the tools menu, click **Spread Curve**.
2. From the **Spread Curve** dialog box, select the spread curve to delete.
3. Click **Delete**.

24

System Utilities

➤ Overview	585
➤ Custom Tools	586
➤ Email Advisor	587
➤ File Management	593
➤ Group Delete.....	608
➤ Open Plan Log Viewer	609
➤ Managing the Data Source	614
➤ Security	616
➤ User Notification in Open Plan.....	620
➤ Sending Project Information Via Email	621
➤ Shortcut Properties	622
➤ Spell Checker.....	624
➤ Web Publisher.....	626
➤ Working in a Multi-User Environment	631

Overview

Open Plan includes a number of special system-level utilities to provide features related to file management and security. Other utilities allow you to communicate project information using the Internet or email.

This chapter discusses each of the system utilities provided by Open Plan and concludes with a brief discussion of working with project data in a multi-user environment.

Custom Tools

By modifying the Addins.dat file, you can customize your installation of Open Plan to display up to 30 custom tools on the **Add-Ins** menu.

An Addins.dat file may be located in two folders:

- The same folder as the Open Plan executable file. Modifying this copy of the Addins.dat file creates menu items that are accessible to all users of the same installation of Open Plan. This copy of the Addins.dat file is installed by default.

Open Plan ships with several custom tools predefined in this copy of the Addins.dat.



For a complete list and description of these tools, refer to Chapter 4, "The Open Plan Configuration Files," in the *Deltek Open Plan Developer's Guide*.

- The User folder of your Open Plan installation. Modifying this copy of the Addins.dat file creates menu items that are accessible only to you. While this copy of the file is not installed by default, you can create it by copying the Addins.dat file located in the Open Plan executable folder and pasting it into your User folder.

You can add up to 30 custom tools to the **Add-Ins** menu in your installation of Open Plan by modifying either or both of these Addins.dat files.

For example, you can add an item to the **Add-Ins** menu that starts the WordPad program supplied by Windows. By making the required modification to the copy of the Addins.dat located in the executable folder, all users of the same installation of Open Plan will have access to this menu item.

You can also add an item to the **Add-Ins** menu that will start Outlook. Since your copy of Outlook may contain private information that you would not want everyone to see, you would make the required modifications to the Addins.dat located in your Open Plan User folder.



For more information on adding custom tools to the Add-Ins menu, refer to Chapter 4, "The Open Plan Configuration Files," in the *Deltek Open Plan Developer's Guide*.

Email Advisor

The **Email Advisor** sends automatically generated email messages from within Open Plan. While the **Email Advisor** can contain any information and can be sent to any person within your organization as well as to anyone with a valid email address, it is typically used to facilitate communication between planners and others involved in the project.

When a project is open, you can access the **Email Advisor** by clicking **Email Advisor** on the **Tools** menu. Doing so displays the following **Advisory Definitions** dialog box:

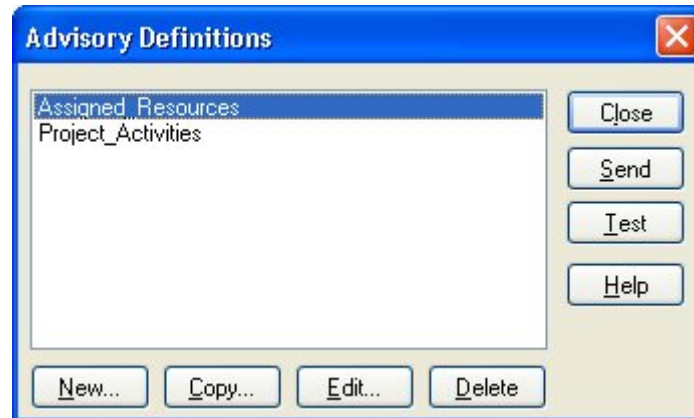

An advisory definition is the name assigned to a set of values that collect project information that can then be sent to recipients in an email.

The **Advisory Definitions** dialog box displays a list of previously defined advisory definitions that you can test and send.

If you are using the Professional or Enterprise edition of Open Plan, you can also use this dialog box to perform the following two functions:

- Delete a previously created advisory definition.
- Display the **Edit Advisor Emails** dialog box that you can use to create or edit an advisory definition.



While all Open Plan users can send a previously created email advisory, only users of the Professional edition can create, modify, or delete one.

You can display the **Edit Advisor Emails** dialog box from the **Advisory Definitions** dialog box in any of the following ways:

- By clicking **New**. This displays a blank **Edit Advisor Emails** dialog box that you can use to create a new advisory definition.
- By selecting an advisory definition and clicking **Copy**. This displays the selected advisory definition in the **Edit Advisor Emails** dialog box. The name of the selected advisory definition is preceded by the word “Copy_” in the **Name** field. You can then either accept this default name for the definition or change it before you save it.

- By selecting an advisory definition and clicking **Edit**. This displays the selected advisory definition in the **Edit Advisor Emails** dialog box and allows you to make changes to the advisory definition.

You can use this dialog box to create or edit an advisory definition using the following fields:

- Name** — Enter any descriptive name for your advisory definition. When saved, the name is listed in the **Advisory Definitions** dialog box.
- Subject** — Enter the subject of the message. In addition to being able to enter text, you can include any field or calculated field from the activity table. You can also enter a title block variable in this field.

For example you might enter **<Project Short Name>** to display the short name of the project in the subject of the email.



Fields, calculated fields, and title block variables must all be enclosed within angle brackets (<>).

- Header** — Enter a header for the message. You may enter constants, standard field names, symbolic field names, or leave the header empty. The header is displayed only once in an email.
- Message** — You can select any field from the list. When the email advisory is generated, Open Plan will address the advisory to any valid entries in the field that you select.

For example, assume that you have assigned CLEANOBS in the **C1** field for your project and that you have entered the following email addresses in a user character field (e.g., C1.USER_CHR01) for the E&D code in CLEANOBS:

johndoe@company.com;marydoe@company.com

Open Plan would generate an email advisory to both johndoe and marydoe for all the activities that have a code of E&D (and that have not been excluded by a filter).



Create a code file to hold addresses and assign this file to a project. Note: Code fields are not selectable from the address field.

You can also specify an addressee by selecting the following fields:

- **<Project Manager Email>** — Selecting this field sends the email advisory to the address specified in the **Project Manager Email Address** field on the **Summary** tab of the **Project Properties** dialog box for the project.
- **<Resource Managers Email>** — Selecting this field sends the email advisory to all resource managers identified in the resource file associated with the project
- **<Subproject Manager Email>** — If the project contains external subprojects, selecting this field sends the email advisory to the **Project Manager Email Address** defined in the specific external subproject containing the triggering event.

If you select **<Subproject Manager Email>** for a project containing no subprojects, Open Plan sends the advisory to the address specified by the **<Project Manager Email>** field.

The syntax for field names and symbolic field names has been extended. Now the user may optionally specify a column width in characters for a particular field that he has included in the message box. The new syntax is the following:

<field or symbolic field name [, OPTIONAL]column width (1..256)>

Note that column alignment is assured only if all columns in the message specify a column width, AND the font used in the email message is a standard monospaced font (i.e., characters are all of equal width). A standard text message in Outlook falls into this category. Also, if any column in the message box specifies the optional width parameter, the divider that normally appears between different activity items ("+++++") will be suppressed.

- **Footer** — Enter a footer for the message. You may enter constants, standard field names, symbolic field names, or leave the footer empty. The footer is displayed only once in an email.
- **Address format** — Describes the format of the **Address** field, and allows you to select from the following two options:
 - **Embedded in the field** — If you use this option, the address referenced in the **Address** field must be contained within square brackets as in the following format: **[mailto:jdoe@company.com]**. Multiple addresses may be used, but each address must be contained within its own set of square brackets as in the following example:
[mailto:jdoe@company.com][mailto:mdoe@company.com]



Use addresses embedded in the field when combining address and non-address text in the same field.

- **Listed in the field** — If you use this option, the addresses referenced in the Address field must be separated by semicolons (;) such as **;jdoe@company.com;moe@company.com**



When using lists, do not include any non-address text in the field.

- **Send one email per address combining all activities** — Select this option to send a single email that includes all of the activities referenced in the email to each addressee. A separator divides each message included in this email.
- **For activities matching filter** — Select a filter from the drop-down list to specify the activities that can generate an email advisory. An ellipsis has been added to the right of the Filter drop-down list. As in other dialogs, it allows the user to invoke the Filter Expression Dialog.

Clicking the buttons located along the right-hand side of the **Edit Advisor Emails** dialog box has the following actions:

- **Save** — Saves the advisory definition, lists its name on the **Advisory Definitions** dialog box, and closes the dialog box
- **Cancel** — Cancels any changes you may have made to the advisory definition and closes the dialog box
- **Send** — Generates the email advisory and sends it to the addresses specified in the definition using your default email application



Open Plan allows a maximum of 50 addresses for each email generated by the Send command.

- **Test** — Displays the **Test Advisory Definition** dialog box for verification of the subject, message, and results before you send the emails
- **Fields** — Displays the **Fields** dialog box that you can use to select data fields that you can embed in both the subject and the text of the **Advisor Email**. Using the **Fields** dialog box, you can, for example, embed the product manager's name and email address in the text of the advisory email.
- **abc** — Runs the spell-checking feature and checks the subject and message fields of the advisory definition.



For more information on the spell-checking feature in Open Plan, refer to the "Spell Checker" section later in this chapter.

- **Access Control** — Select this option to grant rights to other users in the data source to use the advisory definition.
- **Help** — Displays additional information about this dialog box.

To set up an email advisory address list

1. Open the project for which you want to set up an email advisory address list.
2. Display the appropriate view to display the field you want to use for the address. For example, if you want to use the **Code Description** field of a particular code, open the code file that contains that code.



For a list of fields you can use to contain addresses, display the list in the **Address** field of the **Edit Advisor Emails** dialog box.

3. Open the element that will contain the address list, and assign addresses to the field of your choice using any of the following methods:
 - Embedded addresses enclosed in brackets:
[mailto:marydoe@company.com]
 - Multiple addresses entered as a list and separated by semicolons:
john DOE@company.com;marydoe@company.com
 - Email addresses and nicknames referenced from your email address book

The following display shows email addresses added to the description field of a code file:

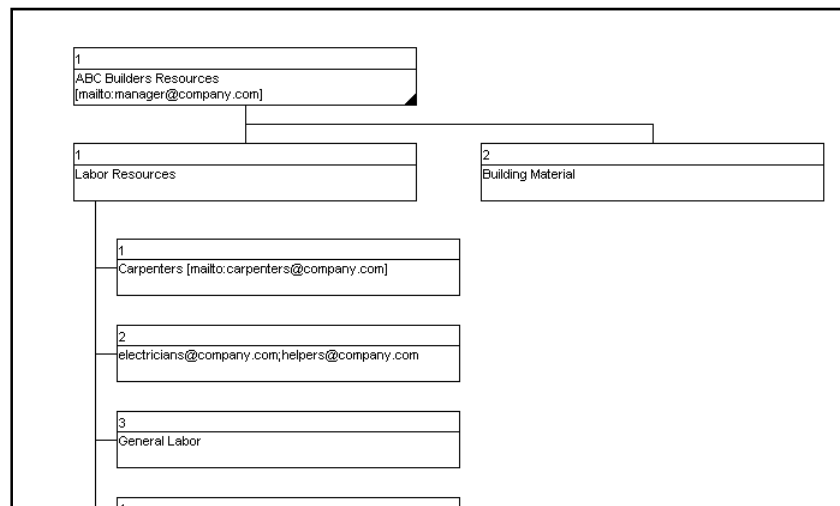

To use Email Advisor in a project

1. Open the project to which you want to create an email advisory.
2. Configure the **Email Advisory** address list.
3. On the **Tools** menu, click **Email Advisor**.
4. From the **Advisory Definition** dialog box, take one of the following actions:
 - Click **New** to create a new advisory definition.
 - Select an advisory definition, and click **Edit**.
5. In the **Edit Advisor Emails** dialog box, enter the definition for the advisory.

6. To review the advisory that will be sent, click **Test**.



This step is optional.

7. If you run the test, click **OK** to return to the **Edit Advisor Emails** dialog box.
8. Click **Save**.
Open Plan saves the advisory definition and returns you to the **Advisory Definitions** dialog box.
9. Select the advisory definition, and click **Send**.

File Management

To help you handle project-related data files, Open Plan provides five functions related to file management:

- Deleting data files
- Backing up projects and associated data files
- Restoring projects and associated data files
- Checking files in and out (Briefcasing)
- Changing a file's access mode

All of these functions are available from the **Manage Files** submenu of the **File** menu.

Deleting a File

With the **Delete File** command, you can delete any project or project-related data file from the data source. On the **File** menu, point to **Manage Files**, and click **Delete File** on the submenu to display the following dialog box:

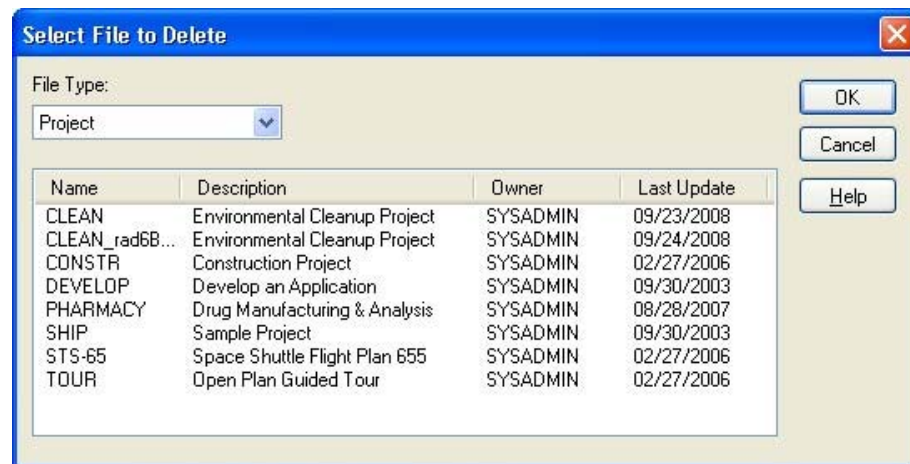

This dialog box displays a list of files based on the type of file you select in the **File Type** field. Also, depending on the file type, Open Plan performs one of the following actions when you delete a file:

- If the file is a project, all the project data is deleted from the data source. The links created in the Project folder to any auxiliary files are removed, but the auxiliary file data itself is not deleted. Any links to the project in your My Folder are also removed.
- If the file is a calendar file, resource file, code file, or view template, the actual data is deleted from the data source.



A file cannot be deleted if it is referred to by another file. For example, you cannot delete a resource file if a project still uses it.

To delete a data file

1. On the **File** menu, point to **Manage Files**.

2. On the **Manage Files** submenu, click **Delete File**.
3. Select the file you want to delete, and click **OK**.
4. When Open Plan asks you to confirm the deletion, click **Yes**.

Backing Up a File

The **Backup File** command allows you to create a backup copy of a project and any of the following associated with that project:

- Calendars
- Codes
- Resources
- System Library
- Views

If the project includes references to external subprojects that are open, these subprojects are included with the master project as well.

By default, all the information about a project and its auxiliary data files is stored by Open Plan in a single file with the extension .bk3. You can also use the **Backup File** command to back up calendar, code, project, resource, system library, and view files outside of the context of a project.



In order to back up a project, you must have write access to it.

On the **File** menu, point to **Manage Files**, and click **Backup File** to display the **Backup** dialog box:

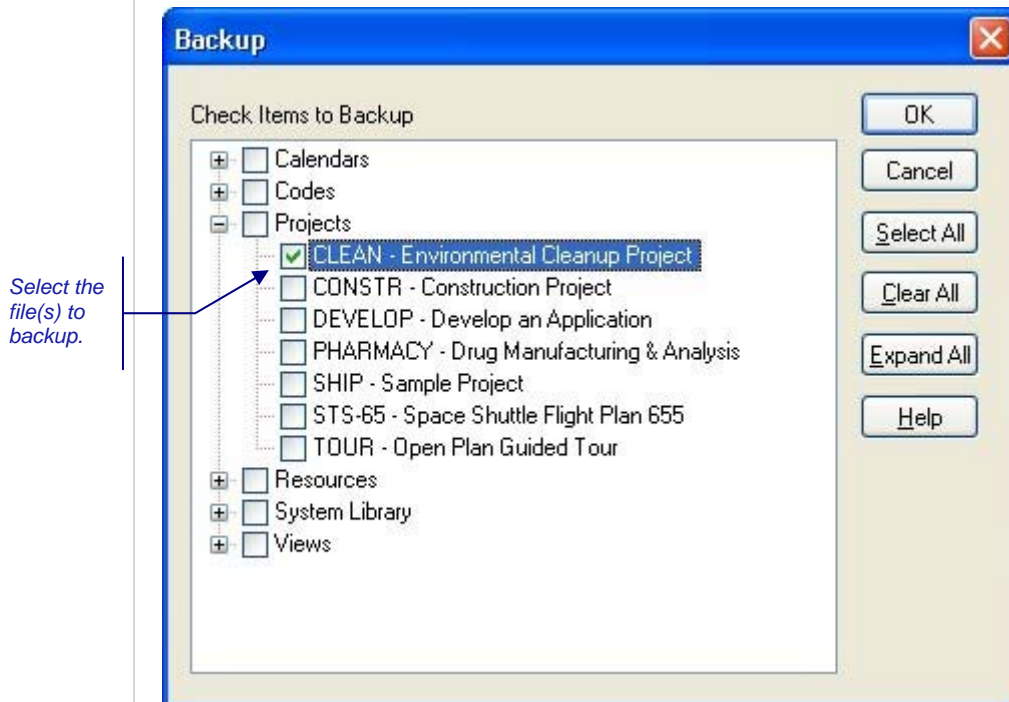

The **Backup** dialog box displays a hierarchical list of all the files in the data source. You can use this dialog box to select the file(s) to back up. After selecting the file(s)

for backup and clicking **OK**, Open Plan displays a **Save As** dialog box where you can enter a name and location for the backup file set.

The buttons along the right hand side of the dialog box have the following functions:

- **OK** — Creates the backup.
- **Cancel** — Closes the dialog box without creating the backup.
- **Select All** — Selects all the files in the list.
- **Clear All** — Clears the check mark from all selected files.
- **Expand All** — Expands all the levels of the hierarchical list for view.
- **Help** — Displays the help system.

To back up a file

1. On the **File** menu, point to **Manage Files**.
2. On the **Manage Files** submenu, click **Backup File**.
3. Select the file(s) you want to back up, and click **OK**.
4. In the **Save As** dialog box, enter a name and location for the backup to be stored.
5. Click **Save**.

Restoring a File

You can use the **Restore File** command to restore the information stored in a backup file set. When you restore a file, Open Plan allows you to provide a new name for the file. This feature is handy in cases where you do not want to overwrite existing versions of the files.

After selecting the backup file set to restore, Open Plan displays the first page of the **Restore** wizard:

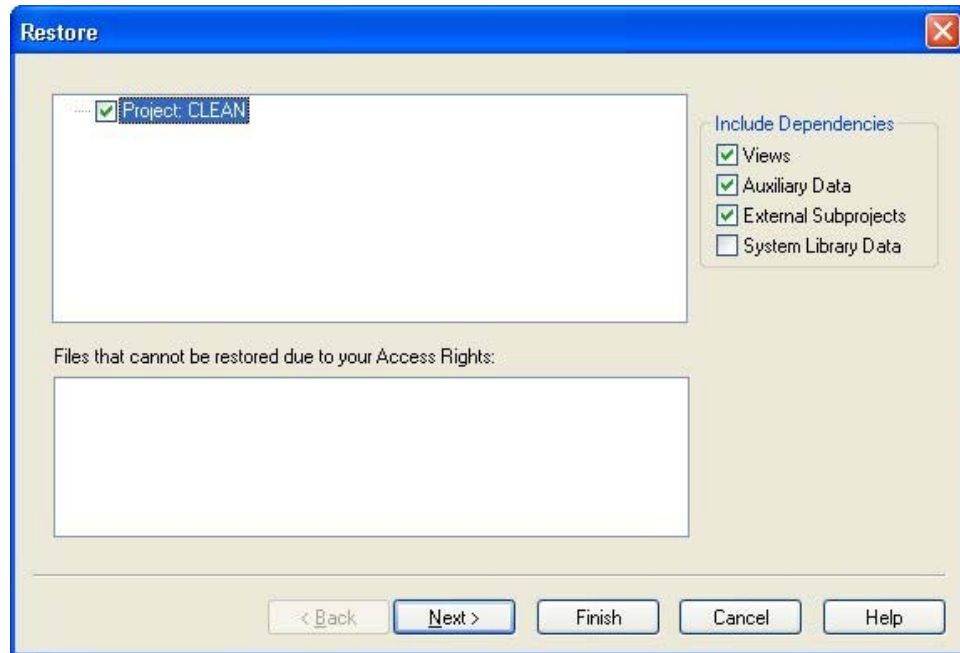

The top list box displays the names of the files in the backup file set. While you can select the items that you want to restore individually, the settings in the **Include** section of this dialog box can be used to simplify this task.

The following options control the categories of items in the hierarchy that Open Plan should select for the restore operation:

- **Views** —This option instructs Open Plan to select all the views associated with any item that will be restored.
- **Auxiliary data** —This option instructs Open Plan to select the Calendar, Resource, and Code items associated with the items to be restored.
- **External Subprojects** — This option instructs Open Plan to select all external subprojects associated with the project that will be restored.
- **System Library Data** — This option instructs Open Plan to select the system library data (such as global edits, filters, sorts, calculated fields, and email advisory definitions) associated with the project to be restored. By default, this option is not selected. Open Plan handles the restoring of system library data as follows:
 - If the system library data does not exist in the target data source (for example, it has been deleted), the data will automatically be restored.
 - If the data already exists in the target data source, it will be listed on the Details page of the Restore Wizard. This gives you the option to overwrite the existing data on a one-to-one basis. For example, if you have modified filters in the target data source, you may not want to overwrite them during the restore process.

You can clear any specific items that you do not want to restore.



If you are trying to restore a file to which you do not have access control rights, that file will appear in the **Files that cannot be restored due to your Access Rights** section of the dialog box.

If you click **Next**, Open Plan displays the **Details** page of the wizard:

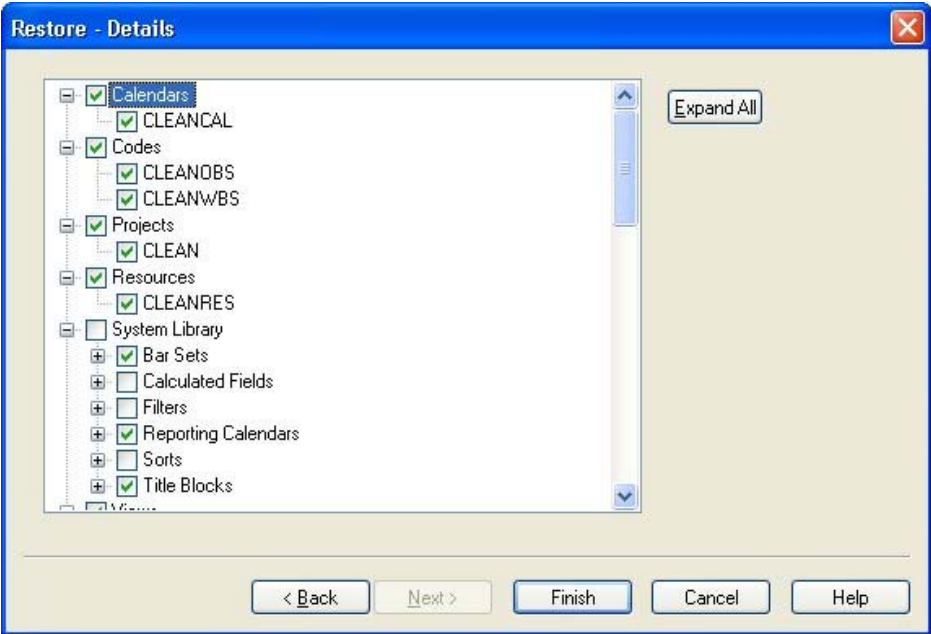

This page of the wizard provides more detailed information about the individual items that can be restored. (Files that cannot be restored due to your access rights do not appear on this page.) You can select or clear as many items as you want from this list.

 If you know that you have not made any changes to some of these items, you can save time by not restoring them.

When you click **Finish** on this page or the previous one, Open Plan checks for any differences between the backup set and the files that will be modified by the restore operation:

- If no differences are found, Open Plan restores the data.
- If any differences are found, Open Plan displays additional dialog boxes where you can instruct Open Plan how to proceed.

Open Plan displays the **Restore Target Exists** dialog box when differences are found between the backup set and the files in the data source:





Differences between the backup set and files in the data source are expected to occur. This dialog then gives you overwrite options you can use to rectify the problem.

You can use this dialog box to instruct Open Plan to do the following:

- **Skip restore of item** — Clicking this option and then clicking **Yes** instructs Open Plan to not restore the identified item. Open Plan redisplay the **Restore Target Exists** dialog box for the next item that will be modified by the restore operation.

If this is a dependent file, Open Plan will retain the link to the existing file of the same name.

Clicking **Yes to All** instructs Open Plan to not restore any of the remaining files in the backup set and closes the **Restore Target Exists** dialog box.

- **Overwrite existing item** — Clicking this option and then clicking **Yes** instructs Open Plan to overwrite the existing item with information from the backup file.

Clicking **Yes to All** instructs Open Plan to overwrite all remaining affected files with information from the backup file.

- **Rename and restore** — When you click this option and click **Yes**, Open Plan enables a text box that you can use to provide a new name for the restored file.

Also, if you choose not to include **Auxiliary Data** and **External Subprojects** when you restore a project and then click **Finish**, Open Plan checks to see if these files already exist in the target data source. If the files do exist, then the restore process proceeds normally. But, if the auxiliary files and external subprojects do not exist, Open Plan displays the following dialog box:



In order for the restore process to proceed, the files in the list on the **Restore Required** dialog box must be restored. Clicking **Restore** instructs Open Plan to automatically restore the files in the list and then proceed with the rest of the restoration process.

If the backup file being restored contains data fields that do not exist in the target data source, Open Plan displays the following dialog box that allows you to create the missing fields in the target data source:

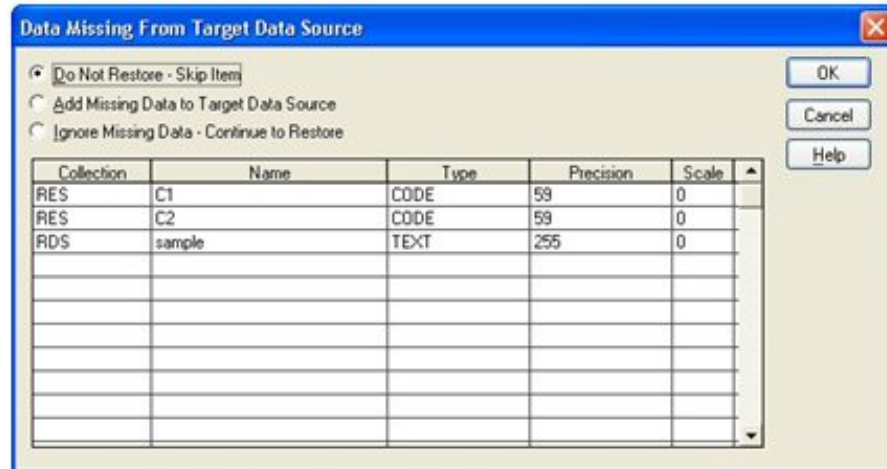

This dialog box features the following controls:

- **Do Not Restore – Skip Item** — Clicking this button instructs Open Plan to interrupt the restoration process and display the **Restore Process** dialog box that you can use to take one of the following further actions:
 - Cancel Restore Process
 - Re-select Restore Files
- **Add Missing Data to Target Data Source** — Clicking this button instructs Open Plan to add the missing data fields to the file that will be modified by the restore operation.
- **Ignore Missing Data – Continue to Restore** — Clicking this button instructs Open Plan to ignore the data that is missing and to continue with the restore operation.

The grid on this dialog box displays the following information for each data field that will be created if you choose to add the missing data to the target data source:

- **Collection** — Displays the name of the table for the missing data field
- **Name** — Displays the name of the data field that will be created
- **Type** — Displays the type of data field that will be created
- **Precision** — Displays the maximum character width of the data field that will be created
- **Scale** — Displays the number of decimal places to use if the missing data field to be created is a numeric field

If Open Plan determines that there are fields present in the backup that it cannot restore into the target data source, it will display the **Fields That Cannot be Restored** dialog box. Normally, if a user has added non-standard fields to Open Plan, their values are backed up during the backup process. Under most circumstances, these will usually be user-defined fields. It is possible, however, for a user to modify the structure of our tables and put non-standard fields in a table that does not support user-defined fields. In this event, Open Plan will not be able to add the missing fields as user-defined fields and displays the new dialog. This dialog will appear in very rare circumstances.

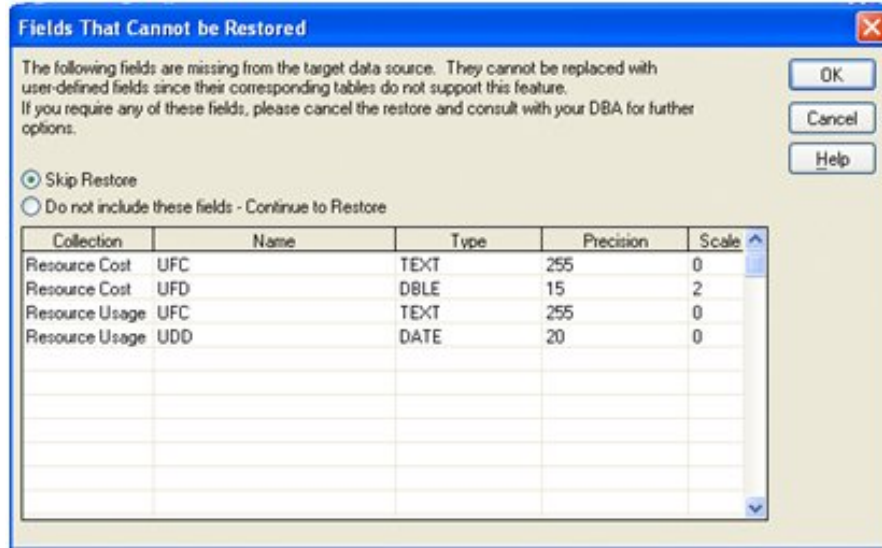

To restore a file

1. On the **File** menu, point to **Manage Files**.
2. On the **Manage Files** submenu, click **Restore File**.
3. From the **Open** dialog box, select the backup file to restore, and click **Open**.
4. Select the files from the backup set to restore using the **Restore** wizard, and click **Finish**.

Briefcasing a File

The Briefcasing feature of Open Plan allows you to check out a project, work on it, and then check it back in. Checking out a project is similar to opening a project in **Exclusive** mode in that while you have the project checked out, you are the only person who can save changes to it. There is, however, a difference:

- A project that is open in **Exclusive** mode is automatically closed when you exit Open Plan. At that time, other users with the appropriate rights can open the project in **Exclusive** or **Shared** mode, make changes, and save their changes.
- A project you check out cannot be modified by other users until you check it back in. Therefore, checking out a project is especially useful when you need to maintain exclusive rights to the project over a longer period of time.

In order to check out a project, you must be able to open it in **Exclusive** mode. This means that in addition to having the appropriate rights to the project, no other user can have it open in either **Exclusive** or **Shared** mode at the time you want to check it out.

Checking Out a File

On the **File** menu, when you point to **Manage Files** and click **Check Out**, Open Plan displays the following dialog box:

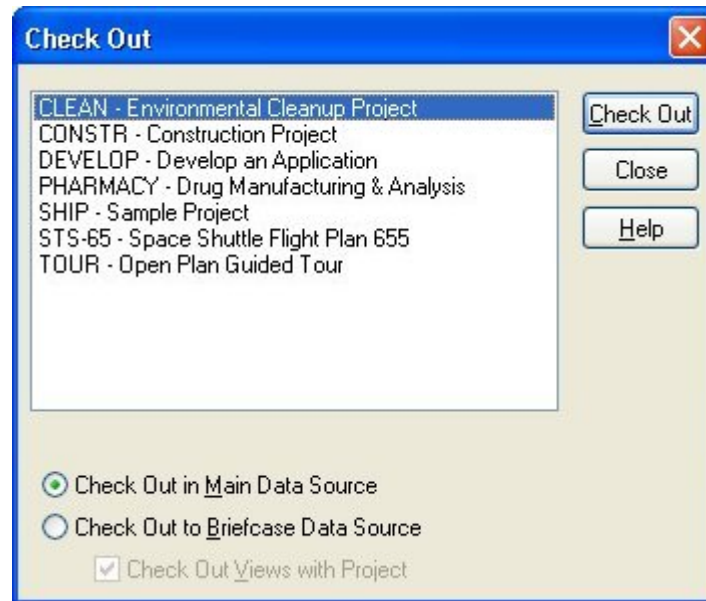

Open Plan allows you to check out a project in two ways:

- **In the Main Data Source** — When a project is checked out in the main data source, it is locked so that it cannot be modified by other users. When you later check in the project, Open Plan removes the lock.
- **To the Briefcase Data Source** — When a project is checked out to the briefcase data source, Open Plan copies the project and all its auxiliary files to your Briefcase data source, which must be running at that time. You also have the option of copying the views used by the project. Checking out a project in this manner allows you to work on your project on another computer.



Your briefcase data source must be called **BRIEFCASING**.

When you check out a project to the Briefcase data source, the copy of the project that remains in the Main data source is locked so that it cannot be modified by other users. When you later check in the project, Open Plan copies the project back to the Main data source and removes the lock. Open Plan also deletes the copy in the Briefcase data source.

When auxiliary files and views are copied to the Briefcase data source with the project, they are not locked in the Main data source since other users may need access to them. Therefore, the auxiliary files and views can be opened only in **Read Only** mode in the Briefcase data source.



You cannot modify or delete any external subprojects, foreign subprojects, or foreign activities a briefcased project may contain, nor can you create these items in the Briefcase data source.

If the project was previously checked out to your Briefcase data source, checking it out again overwrites the data in the Briefcase data source. (You can prevent this from occurring by clicking **No** or **No to All** to the alert that asks whether you want to overwrite the data. This cancels the check out procedure for the duplicated data.)

To check out a project



If the project you want to check out has been opened in **Exclusive** or **Shared** mode by another user, you will not be able to check out the project.

1. On the **File** menu, point to **Manage Files**, and click **Check Out** on the submenu.
2. On the **Check Out** dialog box, select the project you want to check out from the list.
3. Click one of the following options:
 - Check Out in Main Data Source
 - Check Out to Briefcase Data Source
4. If you are checking out to your Briefcase Data Source and want to include the project views, select **Check Out Views with Project**.
5. Click **Check Out**.

Checking In a File

On the **File** menu, when you point to **Manage Files** and click **Check In**, Open Plan displays the following dialog box:

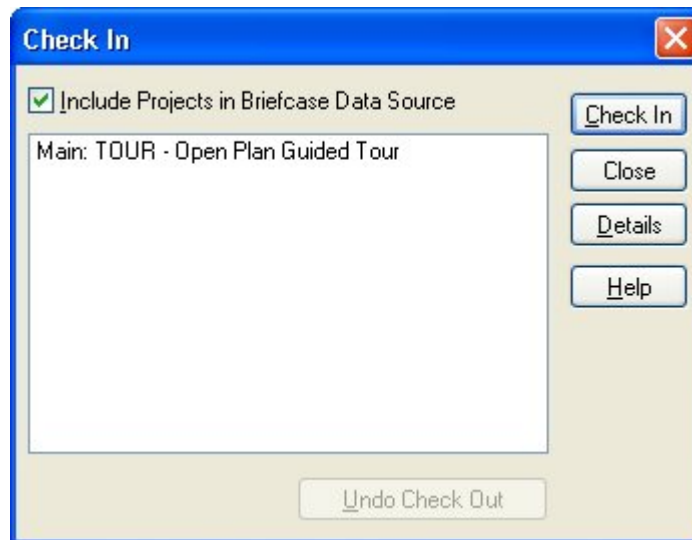

The **Check In** dialog box has the following options:

- **Include Projects in Briefcase Data Source** — Selecting this options will display projects checked out in the Main data source and projects checked out in the Briefcase data source as well as projects created in the Briefcase data source
- **Details** — Clicking this button displays the **Checked Out Projects** dialog box that provides the following information about the projects that are currently checked out:
 - Project
 - User ID

- Machine ID
- Checkout Date
- Data Source
- **Undo Check Out** — If the project was checked out in the Briefcase data source, this option removes the lock from the project in the main data source. Any changes made to the project while briefcased are not copied to the main data source. This option is not available for projects briefcased to the main data source

To check in a project

1. On **File** menu, point to **Manage Files**, and click **Check In** on the submenu.
2. From the list on the **Check In** dialog box, select the project to check in.
If the project was checked out to the Briefcase Data Source, select **Include Projects in Briefcase Data Source** to display the project in the list.
3. Click **Check In**.

Changing the Access Mode

The **Change Mode** command allows you to change the access mode in which you have a file open.

On the **File** menu, point to **Manage Files**, and click **Change Mode** on the submenu to display the following dialog box:

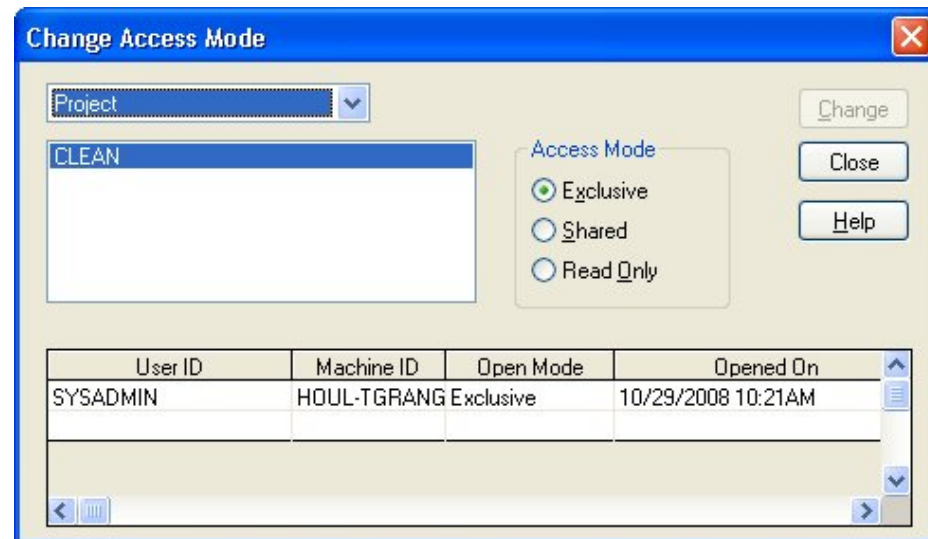

The list box at the top of the dialog box allows you to select the type of file to be displayed in the text box:

- Project
- Calendar
- Resource
- Code

When you select a file from the list, Open Plan displays the following information in a grid located at the bottom of the dialog box:

- **User ID** — This column displays the ID of all the users who currently have the file open.
- **Machine ID** — This column displays the ID of all the computers on which the file is currently open.
- **Open Mode** — This column displays the access mode in which each file is open.
- **Opened On** — This column displays the date on which each file was opened.

The **Access Mode** list displays the modes to which you can change the file. If the file is currently open by another user, the mode in which that user has the file open may impact the changes that you can make. For example, if using the Professional edition of Open Plan, both you and another user have a file open in shared mode, you can only change the mode to **Read-Only**. The **Exclusive** mode is disabled.

Once you have selected a new access mode for the file, you must click **Change** in order to put the new access mode into effect.

To change the access mode of an open file

1. On the **File** menu, point to **Manage Files**, and click **Change Mode** on the submenu.
2. From the **Change Access Mode** dialog box, select the file for which to change the access mode.
3. From the **Access Mode** list, select the new mode for the file.
4. Click **Change**.

Change Ownership and Access Rights

The **Change Ownership and Access Rights** dialog box allows you to change the ownership and/or access control information for one or more project, resource, code, calendar, or view objects. This option is available only to the object's owner or users with System Administrator rights.

This feature is accessed by pointing to **Manage Files** on the **File** menu and then clicking **Change Owner and Access Control**:

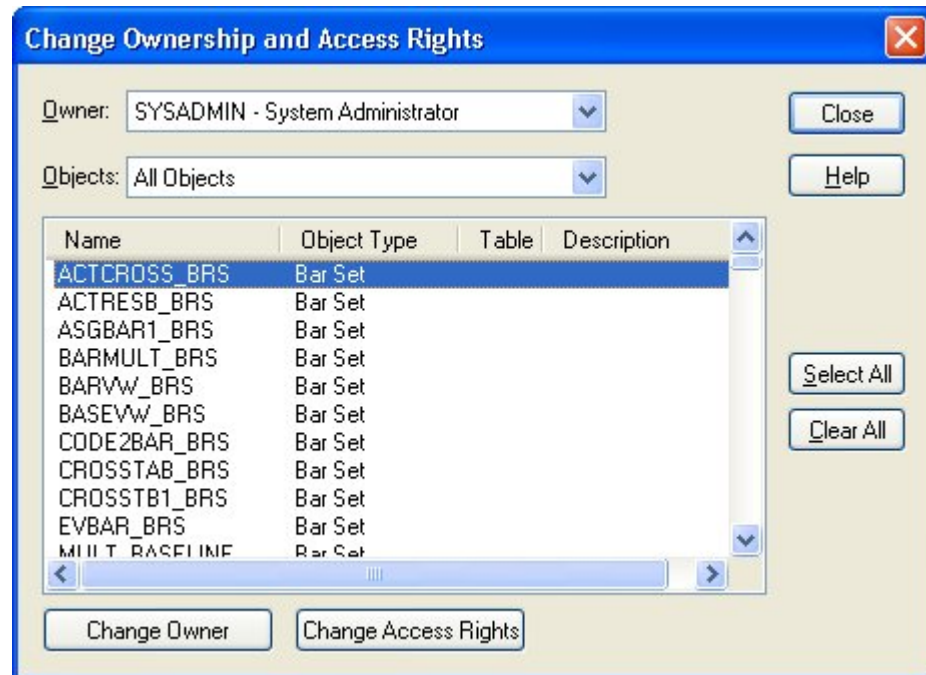

Using the appropriate option, you can filter the display of objects in the dialog box by owner and object type. You can also sort the displayed objects by column in either ascending or descending alphabetical order by clicking the column heading.

Change Owner

Clicking the **Change Owner** button on the **Change Ownership and Access Rights** screen displays the **Change Owner** dialog box:

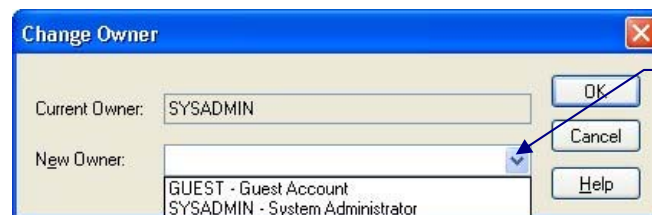

Click here to display a list of available owners.

To change the owner of an object

1. On the File menu, point to Manage Files, and click Change Owner and Access Rights.

Open Plan displays the **Change Owner and Access Rights** dialog box,

2. Select the object or objects for which you want to change the owner.



To select more than one object, use **Ctrl+click** or **Shift+click**. To select all the objects displayed, click **Select All**. Reverse the process to clear selected items, or click **Clear All**.

3. Click Change Owner.

4. From the New Owner list on the Change Owner dialog box, select a new owner.
5. Click OK to save the change.
6. Click Close twice.

Change Access Rights

Selecting one or more objects and then clicking the **Change Access Rights** button displays the following dialog box that you can use to change the access control information for the object(s):

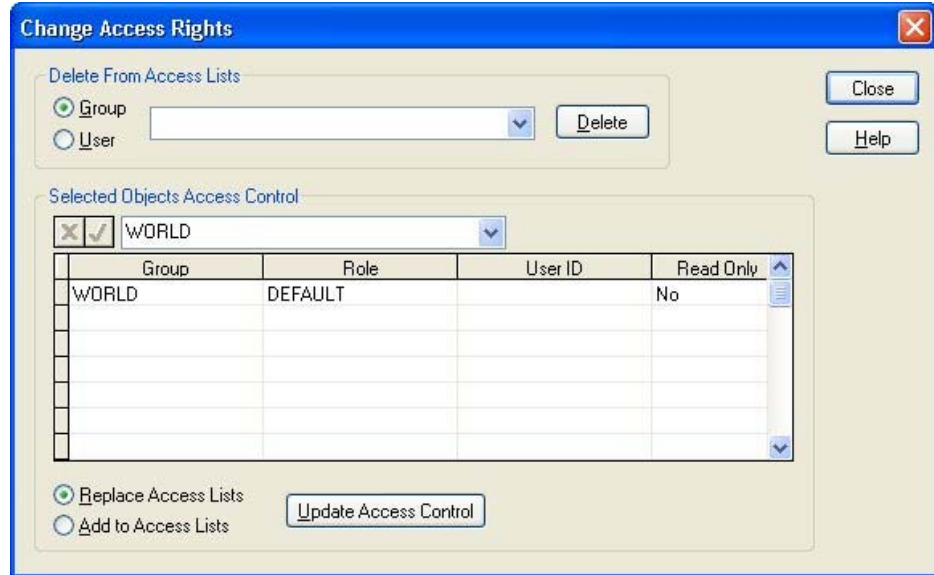

To change the access rights of an object

1. On the File menu, point to Manage Files, and click Change Owner and Access Rights.
Open Plan displays the **Change Owner and Access Rights** dialog box,
2. Select the object or objects for which you want to change the access rights.



To select more than one object, use **Ctrl+click** or **Shift+click**. To select all the objects displayed, click **Select All**. Reverse the process to clear selected items, or click **Clear All**.

3. Click **Change Access Rights**.
4. In the grid on the Change Access Rights dialog box, add or delete groups and users.
5. Select one of the following options:
 - **Add to Access Lists**
 - **Replace Access Lists**
6. Click **Update Access Controls**.
7. Click **Close** twice.

When changing access control information, individual access control entries can be added and deleted or all existing access control entries can be replaced with a new set of access control entries.

Group Delete

The **Group Delete** command allows you to delete a group of data records in an open project that share a common characteristic.

Clicking **Group Delete** on the **Tools** menu displays the **Group Deletion** dialog box.



This dialog box contains the following fields that allow you to apply a filter to a table in the open project and then delete the data records that are identified by the filter criteria.

The dialog box contains the following two fields:

- **Applies to Table** — Contains a list of all the tables in the open project.
- **Matching Filter** — Contains a list of all the filters defined for the open project.

Clicking the **ellipsis** button to the right of the **Matching Filter** field displays the **Filters** dialog box that you can use to create a new filter.

To delete a group of data records in an open project:

1. Open a project in Shared or Exclusive mode.
2. From the **Tools** menu, click **Group Delete**.
3. Select the table from which to delete the data records.
4. Select the filter to use, or click the ellipsis (...) button to create a new filter using the **Filters** dialog box.
5. Click **OK**. Open Plan informs you how many records match the filter criteria and asks you to confirm the deletion.
6. Click **Yes**.

Open Plan Log Viewer

The Open Plan Log Viewer is a stand-alone application that can be accessed in two ways:

- **Within the context of Open Plan** — Allows you to display the log files that have been created during the current session of Open Plan as well as previously saved log files.
- **Outside the context of Open Plan** — Allows you to display only saved log files.

 While you can navigate to the **User** folder and open any of the log files using a text editor such as Windows Notepad, the **Log Viewer** provides a more convenient way to review this information.

To open the **Open Plan Log Viewer** from within Open Plan, click **Log Viewer** on the **View** menu:

Name of the log file

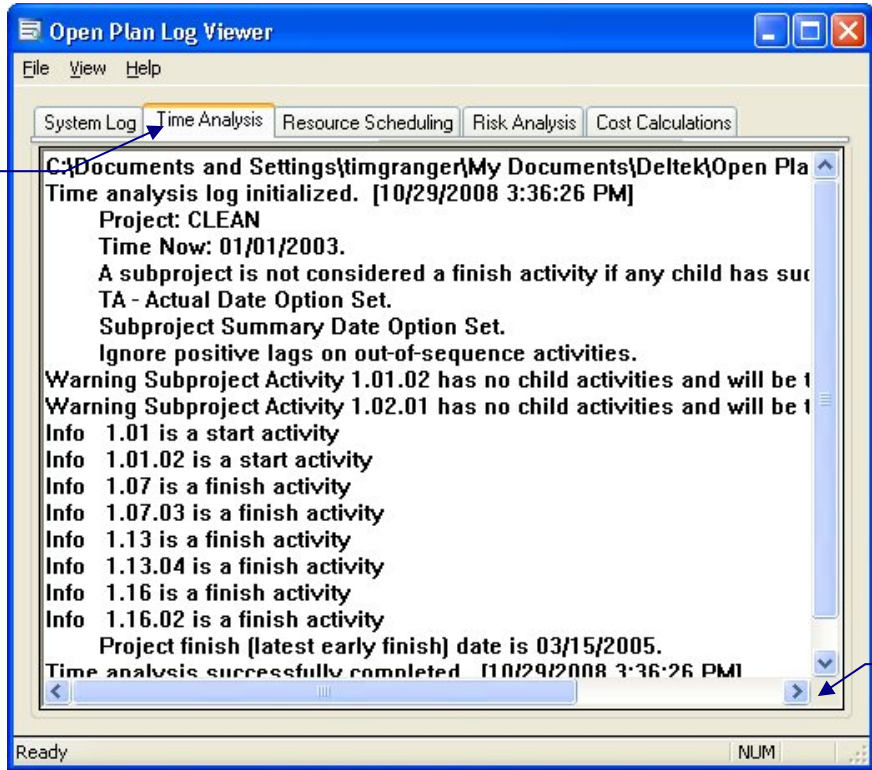

Vertical & horizontal navigation arrows

Open Plan creates a log file each time you run a procedure such as **Time Analysis** or **Resource Scheduling**. These log files provide information about the functions that have been performed.

If more logs are created than can be displayed at once in the **Open Plan Log Viewer**, Open Plan provides two navigation arrows you can use to scroll horizontally through the tabs.

Open Plan Log Viewer File Menu

From the **File** menu, you can:

- **Save** a log file
- **Open** a previously saved log file
- **Close** a log file
- **Print** a log file

When run from within Open Plan, the **Open Plan Log Viewer** features the following tabs:

- **System Log** — Unless you have performed a process such as **Time Analysis** or **Resource Scheduling**, the **System Log** is the only tab that is displayed. This tab allows you to view the **opwin.log** that provides information such as the time the Open Plan executable file was opened and the location of the **opwin.log**.



All the log files are stored in the same directory.

- **Time Analysis** — This tab is displayed when you run time analysis on a project. It allows you to view the **opp_ta.log** that provides information that was generated during the procedure. If you run time analysis on more than one project during your Open Plan session, the **Time Analysis** tab displays information about the last project on which you ran the procedure.
- **Resource Scheduling** — This tab is displayed when you run resource scheduling on a project. It allows you to view the **opp_rs.log** that provides information that was generated during the procedure. If you run resource scheduling on more than one project during your Open Plan session, the **Resource Scheduling** tab displays information about the last project on which you ran the procedure.
- **Risk Analysis** — This tab is displayed when you run risk analysis on a project. It allows you to view the **opp_risk.log** that provides information that was generated during the procedure. If you run risk analysis on more than one project during your Open Plan session, the **Risk Analysis** tab displays information about the last project on which you ran the procedure.
- **Cost Calculations** — This tab is displayed when you run cost calculations on a project. It allows you to view the **opp_cost.log** that provides information that was generated during the procedure. If you run cost calculations on more than one project during your Open Plan session, the **Cost Calculations** tab displays information about the last project on which you ran the procedure.
- **Progress Calculations** — This tab is displayed when you run progress calculations on a project. It allows you to view the **opp_prog.log** that provides information that was generated during the procedure. If you run progress calculations on more than one project during your Open Plan session, the **Progress Calculations** tab displays information about the last project on which you ran the procedure.
- **Backup/Restore** — This tab is displayed when you backup or restore Open Plan files. It allows you to view the **opp_bkp.log** that provides information that was generated during the backup or restore procedure. If you perform more than one backup or restore during your Open Plan session, the **Backup/Restore** tab displays information about the last operation.

- **Import/Export** — This tab is displayed when you transfer data between Open Plan and another application. It allows you to view the **opp_xfer.log** that provides information that was generated during the transfer operation. If you perform more than one import or export procedure during your Open Plan session, the **Import/Export** tab displays information about the last transfer operation.

With the exception of the **System Log**, each of these tabs is displayed only when you perform the relevant operation. If more logs are created than the **Log Viewer** can display at one time, Open Plan provides navigation arrows that you can use to scroll through the tabs, or you can maximize the window to view all the tabs at once.

If you have the **Open Plan Log Viewer** running when you run an Open Plan procedure that creates a log, the log viewer, by default, will automatically refresh its display at a user-defined time interval. You can manually refresh the display by clicking **Refresh** on the **View** menu or by pressing F5.



If you run the **Open Plan Log Viewer** outside the context of Open Plan, refreshing the display will have no effect.

When you open a previously saved log file, the tab created for the opened log file displays the log file's name.

While you cannot edit the information in any of the log files using the **Open Plan Log Viewer**, you can copy text from a log and paste it into another Windows application.

Find In Log Dialog Box

Clicking the **View** menu and selecting **Find** displays the **Find in Log** dialog box:

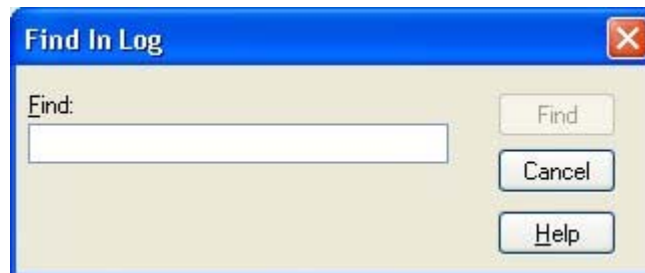

You can use this dialog box to find a specific text string in the log displayed in the viewer. You can press **F3** or click the **Find Next** button to find the next occurrence of the specified text string in the log.



The **Find in Log** dialog box is not case sensitive.

Log Viewer Options

Clicking **Options** on the **View** menu displays the **Options** dialog box.



The **Options** dialog box allows you to set the following options for the **Open Plan Log Viewer**:

- **Enable automatic refresh** — While in Open Plan, if you have the **Open Plan Log Viewer** running when you execute one of the Open Plan processes which creates a log, the log viewer becomes out of sync with the new log information. For example, assume you just performed **Time Analysis** and have viewed the log file. Also assume that while the **Open Plan Log Viewer** is still running, you perform **Time Analysis** again. The new time analysis log generated by the process does not overwrite the currently displayed (old) time analysis log. To view the new log, you have to refresh the **Open Plan Log Viewer** display.

The **Enable automatic refresh** option will refresh the display automatically according to a user-defined time interval. This option is selected by default. If you deselect this option, you can still manually refresh the display using one of the following methods:

- From the **View** menu, click **Refresh**.
- Press **F5**.
- Close the **Log Viewer**, and reopen it.



If you are running the **Open Plan Log Viewer** outside the context of Open Plan, refreshing the display will not have any effect.

- **Enable autoscroll** — If you have a log file that is longer than the display screen, this option will automatically scroll to the end of the log file when you first view it.
- **Refresh files every X seconds** — If you are using the **Enable automatic refresh** option, you can set the time interval in seconds that the **Open Plan Log Viewer** uses when automatically refreshing the display. For example, if you wanted the display to refresh every 2 minutes, you would enter 120 seconds. By default, this option is set to 10 seconds.
- **Default log file path** — The log file path you enter in this field is the starting location the **Open Plan Log Viewer** uses when you execute the **Open** command.



While you can change the path in this field as many times as you want, clearing this field does not automatically revert the path back to the default path. The last path name entered is remembered regardless if you clear it from this field.

You can either type the full path name directly in this field, or you can click the **ellipsis** button to display a dialog box that you can use to select the desired location.

Closing Open Plan removes all the tabs from the **Open Plan Log Viewer**.

Managing the Data Source

Open Plan allows you to manage your data source using the Data Sources dialog box. Clicking Data Sources on the Tools menu displays the following:



This dialog box features the following:

- **Data Sources** — Displays a list of data sources to which you can connect.
- **Add** — Clicking this button displays the Windows **Data Link Properties** dialog box that you can use to configure a data source and add it to the list displayed in the **Data Sources** dialog box.
- **Edit** — Selecting a data source from the list and clicking this button displays the **Edit Data Source** dialog box that you can use to modify settings for the selected data source.
- **Delete** — Selecting a data source from the list and clicking this button deletes the data source.

You can easily change to a different data source by selecting it from the list.

To change to a new data source

1. On the **Tools** menu, click **Data Sources**.
Open Plan displays a list of available data sources.
2. Select the data source to which you want to connect, and click **OK**.
Open Plan informs you to restart the program to use the new data source.



You will have to complete the normal log-on sequence upon restarting Open Plan to successfully complete the connection.

Editing a Data Source

When you select a data source from the **Data Sources** dialog box and click **Edit**, Open Plan displays the following dialog box:

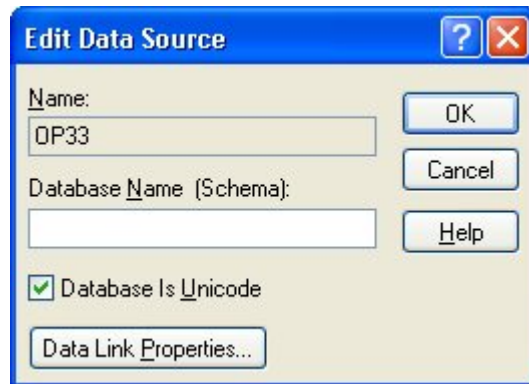

The **Edit Data Source** dialog box has the following controls:

- **Name** — The name of the currently selected data source is displayed in this field. You cannot edit this field.
- **Database Name (Schema)** — Use of this field is optional. If you wish, you can enter the schema name of the selected database in this field.



If you do not enter a schema name in this field, the Datasources.dat file must identify an Initial Catalog for the database.

- **Database is Unicode** — Select this option only if the database is in Unicode. MS Access databases are always in Unicode. Additionally, this option is used for double-byte languages such as Chinese, Russian, and Hebrew.
- **Data Link Properties** — Clicking this button displays the Windows **Data Link Properties** dialog box that you can use to specify how to link to the server where the database is stored.

If you are currently connected to the data source you are modifying, your changes will not take effect until the next time you start Open Plan.

To edit a data source

1. On the **Tools** menu, click **Data Sources**.
2. On the **Data Sources** dialog box, select the data source that you want to edit.
3. Click **Edit**.
4. In the **Edit Data Source** dialog box, make any needed modifications.
5. Click **Data Link Properties**.
6. In the Windows **Data Link Properties** dialog box, enter the appropriate settings for the data source.
7. Click **OK** to return to the **Edit Data Source** dialog box.
8. Click **OK** again to return to the **Data Sources** dialog box.

Security

You can perform the following security-related operations from within Open Plan:

- Define access rights for project data
- Change your user password

These operations are described in the following sections.

Defining Access Rights

You can define the access rights to any project, resource file, calendar file, code file, view template, and baseline file for which you are the “owner.” By default, the owner of a file is the user who creates the file. By creating the file, the owner is automatically given full read/write access rights to the data and can grant rights to other users.



Both the current owner and any user in the SYSADMIN group can transfer ownership of the file to another user.

Security access rights are granted the same way for all files except a baseline. The following example shows the **Access Control** tab (in this case for a project) that you can use to grant access rights to other users:

Group	Role	User ID	Read Only
WORLD	DEFAULT		No



For information on defining access rights to a baseline, refer to Chapter 16, “Status Information.”

As the owner, you can use the following fields to grant access rights to other users:

- **Owner** — If you are the owner or have SYSADMIN privileges, you can select a new owner for the file from this list.
- **Group** — This field allows you to grant access rights to an entire user group. User groups are created within Security Administrator.
- **Role** — You can use this field to assign a role to either a group or individual user. By assigning a role, you can control how the group or user manipulates your file. Roles are created within Security Administrator, and groups are

assigned default roles. With this setting, you can override the default role of a group.

- **User ID** — This field allows you to grant access rights to individual users. User IDs are created within Security Administrator.
- **Read Only** — Selecting **Yes** for this field limits the group or individual to read-only status for the file regardless of the role assigned.

If you provide access rights to a group for a project, members of that group automatically inherit read rights to all resource files, calendar files, code files, and external subprojects assigned to that project. Note, however, it is possible that after you change the ownership of a project to another user, you may not have rights to save the project. If this occurs, simply close the project without saving.



Provided that you are the owner or have SYSADMIN rights, you do not have to open a project or file in order to grant access rights to it on this tab.

To define access rights to a project



You must be the owner of the project or have SYSADMIN rights in order to define access rights to it.

1. Select the project for which you want to define access rights.
2. Take one of the following actions:
 - On the **Project** menu, click **Properties**.
 - Right-click the project folder, and click **Properties** on the context menu.
3. Click the **Access Control** tab.
4. Assign access rights to the project.
5. When finished, click **OK**.

To define access rights to a resource file, calendar file, code file, or view template



You must be the owner of the file or view template in order to define access rights to it.

1. In the Open Plan Explorer, right-click the appropriate file or view template, and click **Properties** on the context menu.
2. Click the **Access Control** tab.
3. Assign access rights to the file.
4. When finished, click **OK**.

Changing Your User Password

To change your user password (that is, the password you enter when you start Open Plan), use the **Change Password** command to display the following dialog box:

To change your user password

1. On the **File** menu, click **Change Password**.
2. In the **Old Password** field, enter your old password.
3. In the **New Password** field, enter your new password.
4. In the **Re-enter New Password** field, re-enter your new password for verification.
5. Click **OK**.

Security Administrator

The Deltek family of products provides a comprehensive set of security-related features that allow a system administrator to control access to both an application and its data. These features are accessed through the **Security Administrator**, a common security utility designed to work with Deltek's software applications. Security features that might affect an Open Plan user are described in this section.

Login Lockout

Using the **Security Administrator**, a user with system administrator access can prevent users from logging into Open Plan. When users try to log into Open Plan, they receive a message stating that the system administrator has disabled logins to the data source. Clearing the message returns the users to the Open Plan Login dialog box, where they can cancel the login attempt completely or use **Ctrl+Login** to select another data source.

This function would be useful, for example, if maintenance needed to be performed on the database. If even one user was logged in, the maintenance could not be performed.

Login Message

Using the **Security Administrator**, a user with system administrator access can specify a message that is displayed to all users when they log into Open Plan. This function would be useful, for example, to warn users of scheduled downtime for upcoming database maintenance.

Session Termination Function

Using the **Security Administrator**, a user with system administrator access can remotely terminate the Open Plan session for any user logged into the program. When a user's session is terminated, the user receives a warning that Open Plan has been terminated by the system administrator and will automatically close in 10 seconds.

Please note that any unsaved changes to Open Plan are lost when the program is remotely terminated by the system administrator. Once the termination message is displayed, users cannot perform any actions in Open Plan. Hopefully, the system administrator sent a message to the users informing them to save their information before issuing the session termination.

User Notification Function in Security Administrator

Using the **Security Administrator**, a user with system administrator access can send a message to any user logged into Open Plan. Messages can be sent to individual users or several users at once.

This function is similar to the **Send Message** command on the Open Plan **File** menu.

This function would be useful, for example, if the system administrator needed to inform all users to log out so that database maintenance could be performed.



For more information on the **Security Administrator**, see the *Security Administrator Guide*.

User Notification in Open Plan

An Open Plan user can send a message to another user who is logged in to Open Plan. To send a message, click **Send Message** on the **Tools** menu to display the **Send Message** dialog box:

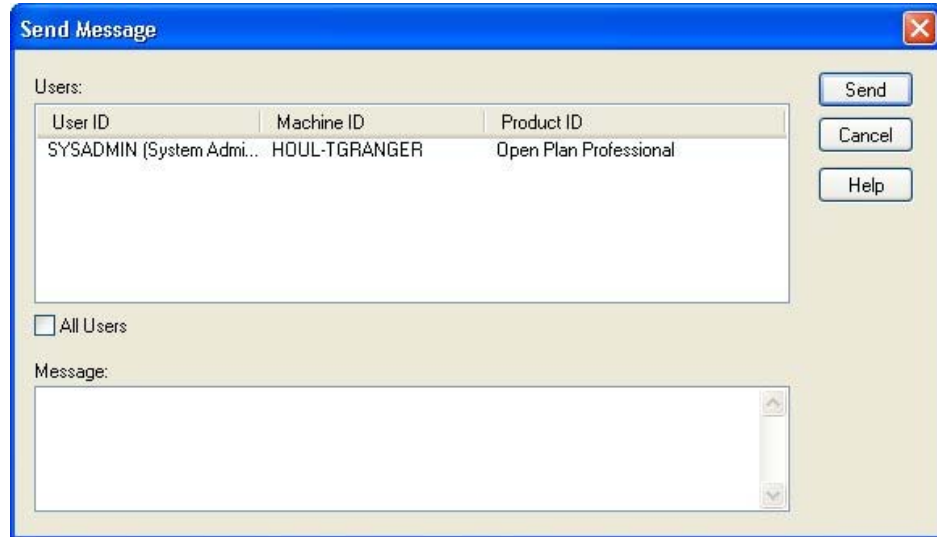

When the message is sent, a message box pops up on the recipient's screen. The message box displays your user name and date/time the message was sent along with the message.

To send a message to a user

1. From the **Tools** menu, click **Send Message**.
2. From the Users pane on the **Send Message** dialog box, select the recipient(s) of your message. Select **All Users** to send a message to all logged in users.
3. Type your message in the Message pane (maximum 250 characters).
4. Click **Send**.



You cannot send a blank message or a message without a recipient.

Sending Project Information Via Email

If your installation of Windows specifies a MAPI-compliant application (such as Microsoft Outlook) as your default email system, you can use the Open Plan email feature to send project, resource, or code information using electronic mail.

When you click **Send** on the **File** menu, Open Plan creates a backup file of the current data, invokes your email application, and creates a blank email message with the backup file as an attachment. If you have a view open at the time you click the **Send** command, Open Plan attaches the view as well.

To email a project

1. Open the project, resource file, or code file that you want to attach to an email.
2. On the **File** menu, click **Send**.



This command is not available if you do not have a MAPI-compliant email application designated as your default email system.

3. On the **Backup Items To Send** dialog box, verify the file you are sending, and click **OK**.

You can change which files are sent by selecting or clearing the appropriate files.



For information on backing up a file, refer to "Backing Up a File" earlier in this chapter.

4. On the **Save As** dialog box, enter a name and location for the backup, and click **Save**.



Choosing the default name and location Open Plan uses will save the file in the Windows\Temp folder.

Open Plan invokes your email application, creates a blank message, and attaches the appropriate files.

Shortcut Properties

You can change the properties of a shortcut by displaying its **Properties** dialog box. There are two different dialog boxes that are displayed depending on the type of shortcut it is.

If the shortcut is to a Windows application or file, a dialog box similar to the following is displayed:



This dialog box has the following controls:

- **Target** — Specifies the name of the item to which this shortcut points
- **Arguments** — Specifies optional parameters that are passed on to the target
- **Start in** — Specifies the folder that contains the original item or some related files
- **Run** — Specifies how you want the window to display this item when you open the shortcut:
 - In a standard window (Normal)
 - In a full screen (Maximized)
 - As a button on the taskbar (Minimized)

If the shortcut is to a URL, the following dialog box is displayed:



You can use this dialog box to change the target URL for the shortcut.

To edit the shortcut properties

1. In the Open Plan Explorer, locate the shortcut.
2. Right-click the shortcut, and click **Properties** on the context menu.
3. On the **Properties** dialog box, make the desired changes.
4. Click **OK**.

To change the name of a shortcut

1. In the Open Plan Explorer, locate the shortcut.
2. Right-click the shortcut, and click **Rename** on the context menu.
3. Type a new name for the shortcut.
4. Press **Enter**.

Spell Checker

The full-featured spell checker allows you to specify the dictionaries that you want to use. You can use up to 32 dictionaries. If you have defined special terms in a dictionary, you can simply assign that dictionary to the Open Plan spell checker. Open Plan also allows you to assign many different language dictionaries so that you can check the spelling of words in other languages.

In addition to using the dictionary files shipped with Open Plan, you can create your own custom project dictionary. This dictionary can be any of the following types.

- **.tlx** – The default dictionary type for the Open Plan spell checking feature
- **.dic** – The default dictionary type of Microsoft Word and other word processing programs
- **.txt** – The default dictionary of custom dictionaries and dictionaries containing acronyms



You can add acronyms as shortcuts for other words. The spell checking feature finds the acronym and offers you suggested replacement words. For example, you can define 'sw' as a shortcut for software. If you have existing acronym dictionaries, you can import these dictionaries and use them in Open Plan.

The following spell check button has been added to the **Email Advisor** and all **Notes** tabs:

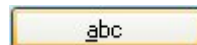

When using the spell checking feature, the following dialog box is displayed whenever a word is encountered that cannot be found in the current dictionaries.

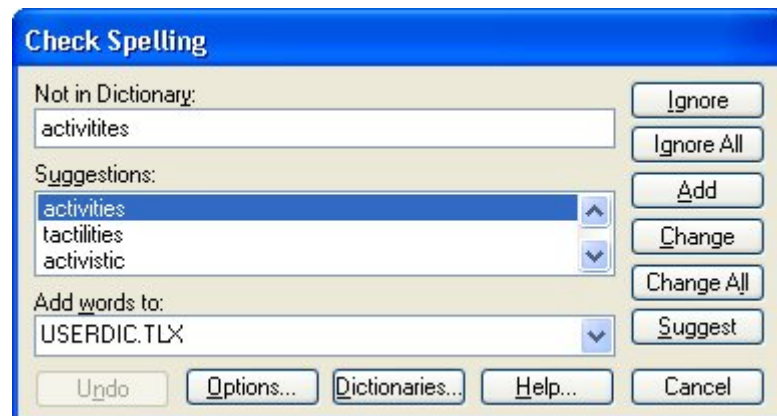

In addition to highlighting unrecognized words, this dialog box also suggests words that you might want to use as replacements.

Two buttons located at the bottom of the dialog box provide access to customizable spell checker features: **Options** and **Dictionaries**

Clicking the **Options** button displays the following dialog box that you can use to specify the options you want to use:

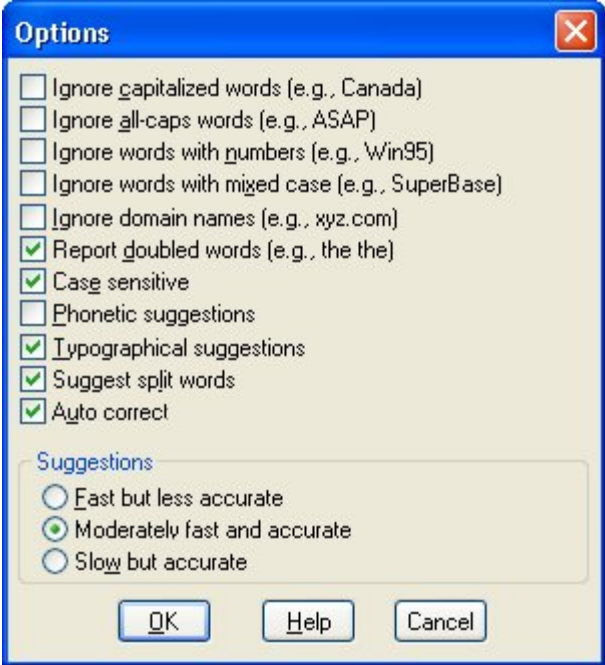

Clicking the **Dictionaries** button displays the following dialog box that you can use to add new dictionaries and to add or delete words from the current dictionary:

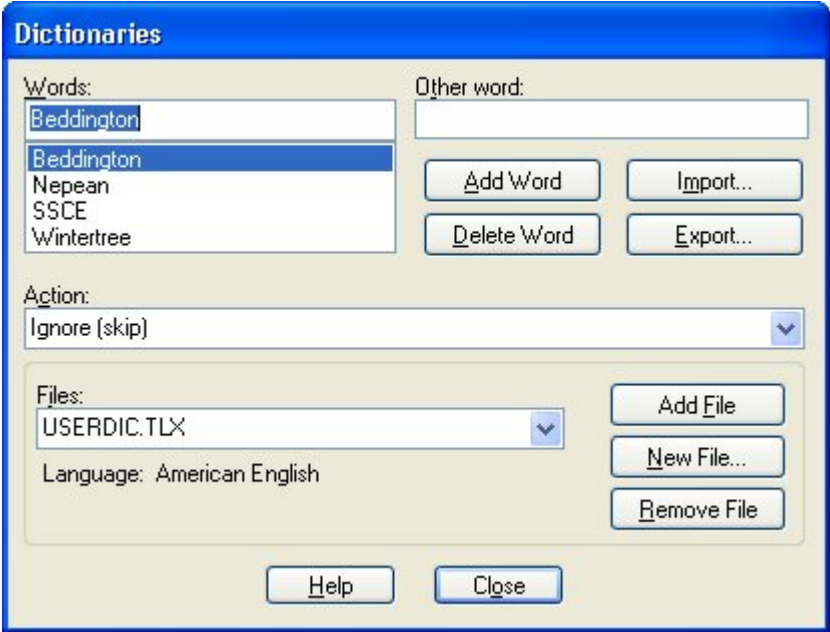

 For more information on enhancing the spell checking feature, click **Help** on the **Check Spelling** dialog box.

Web Publisher

The **Open Plan Web Publisher** allows you to publish any Open Plan view or report as a document that can be viewed by most common World Wide Web browsers. By producing reports using the industry-standard Hyper Text Markup Language (HTML) and Adobe Acrobat's Portable Document Format (.pdf), you can provide electronic versions of the most up-to-date project information to any project member.



Adobe Acrobat Writer is needed for the creation of HTML reports using the Open Plan Web Publisher and is not included with your installation of Open Plan.

For example, assume that one of your responsibilities as a project manager is to gather information each month about the current status of one or more projects, update a set of standardized reports to reflect the revised schedule, and make these reports available to the appropriate managers in your organization.

With the Open Plan Web Publisher, you can assign a group of project views to a report batch and then have Open Plan output each report as a .pdf file. These files can be displayed by any user who has the Adobe Acrobat Reader software, which is available for a number of different hardware platforms. In addition to the reports in the batch, Open Plan produces an HTML document that lists each report in the batch:

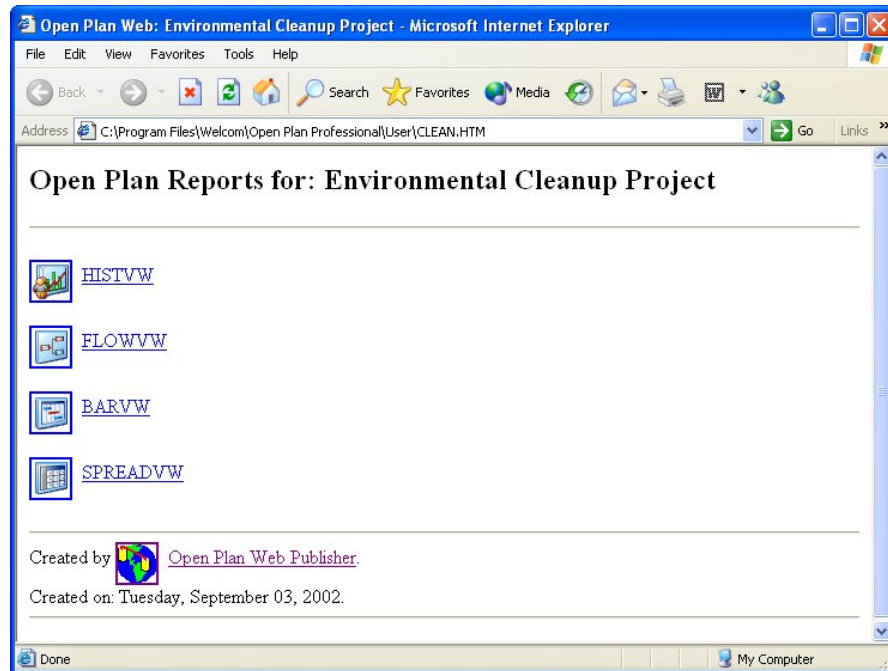

Each icon in the HTML document serves as a Uniform Resource Locator (URL) link to a .pdf file generated from a view. This HTML document can then be placed on any Web server, making the views available to all users with access to that server. To display a view listed in the HTML file, simply click the appropriate icon.

To produce reports for publication on the Web, you must have the Adobe Acrobat PDFWriter (included in packages such as Adobe Acrobat Exchange) installed as an output device for your Windows system.

To view a report produced in the .pdf format, you must have an installed copy of Adobe Acrobat Reader. This software is available at no charge from Adobe (<http://www.adobe.com>). The Windows version of Acrobat Reader is included with your copy of Open Plan.

To view a report produced in the .pdf format on the Web, your Web browser must support the use of Acrobat Reader as a helper application.

In addition to producing reports for the Web, the Open Plan Web Publisher can also be used as a facility for defining and running report batches that can be produced to any output device defined for your Windows system.

 For information about customizing the operations of the Open Plan Web Publisher, refer to Chapter 15, "Customizing the Open Plan Web Publisher," in the *Deltek Open Plan Developer's Guide*.

Creating a Report Batch

To use the Open Plan Web Publisher to create a report batch, open the project you want to process, and click **Web Publisher** on the **Tools** menu.

If you do not have a project open at the time you click the command, the Open Plan Web Publisher prompts for a project to open before proceeding.

Once you have selected a project, the Open Plan Web Publisher displays the following dialog box:

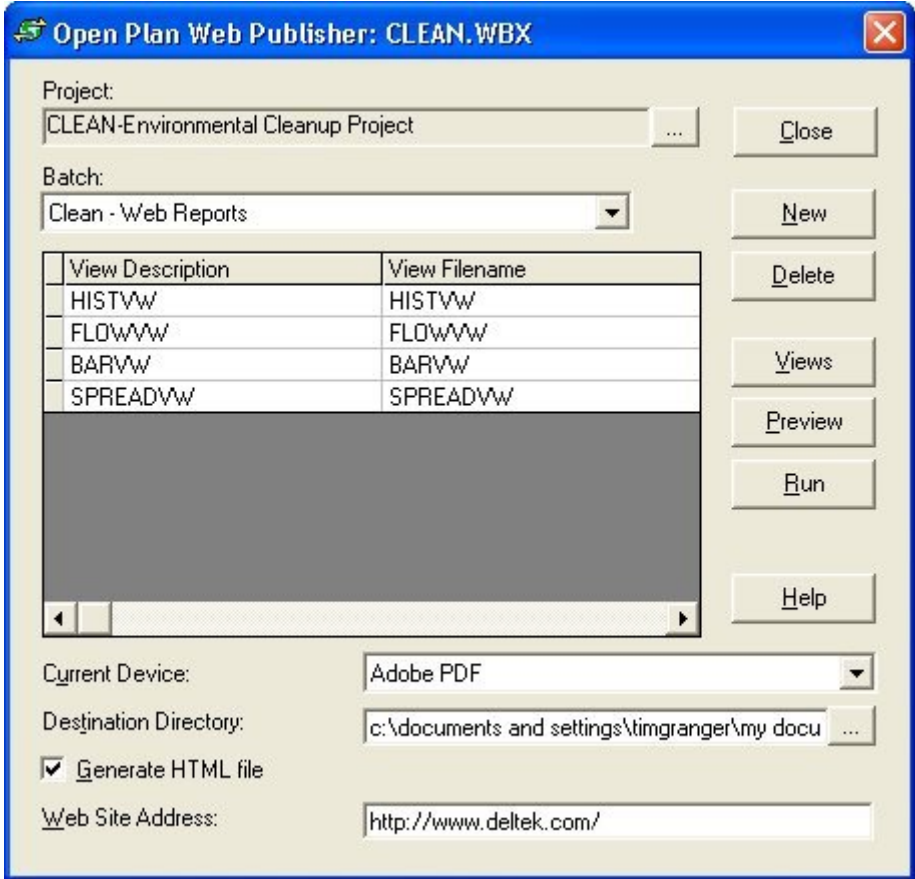

Use this dialog box to display a list of the views currently included in a report batch.

 To see the file name for the views, scroll the list horizontally.

To create a new batch, click **New**, and provide a name for the batch. When you return to the **Open Plan Web Publisher** dialog box, click **Views** to define the views to include in the batch. The Open Plan Web Publisher responds by displaying the following dialog box:



Use the controls in the dialog box to create a list of views to be published with this batch as follows:

- To include all of the project views in the report batch, click **All>>** .
- To remove all the views from the report batch, click **<<All**.
- To include specific views in the report batch, select the items from the list of available views, and click **Include >>**.
- To remove specific views from the report batch, select the items from the list of views to publish, and click **<< Remove**.

 You can also include or remove views from a list by either double-clicking the name of the view or selecting the view and pressing the space bar.

When you have finished defining the views for the batch, click **OK** to return to the **Open Plan Web Publisher** dialog box.

In addition to creating new report batches, you can use the **Open Plan Web Publisher** dialog box to update, delete, preview, and run existing batches.

To create a report batch

1. Open the project for which you want to create a report batch.
2. On the **Tools** menu, click **Web Publisher**.
3. On the **Open Plan Web Publisher** dialog box, click **New**.

 If there are no report batches for this project, Open Plan automatically invokes this procedure.

4. Enter a name for the new report batch, and click **OK**.
5. On the **Open Plan Web Publisher** dialog box, click **Views**.
6. In the **Add or Remove Views** dialog box, select the views to add to the report batch, and click «**Include**.
7. When the information for the batch is correct, click **OK** to return to the **Open Plan Web Publisher** dialog box.

To update a report batch

1. Open the project containing the report batch you want to update.
2. On the **Tools** menu, click **Web Publisher**.
3. From the **Open Plan Web Publisher** dialog box, select the report batch to update.
4. Click **Views**.
5. In the **Add or Remove Views** dialog box, update the list of views contained in the batch.
6. When the information for the batch is correct, click **OK** to return to the **Open Plan Web Publisher** dialog box.

To delete a report batch

1. Open the project containing the report batch you want to delete.
2. On the **Tools** menu, click **Web Publisher**.
3. From the **Open Plan Web Publisher** dialog box, select the report batch to delete.
4. Click **Delete**.
5. When Open Plan asks you to confirm the operation, click **OK**.

To preview a report

1. Open the project containing the views you want to preview.
2. On the **Tools** menu, click **Web Publisher**.
3. From the **Open Plan Web Publisher** dialog box, select the report batch containing the views you want to preview.
4. From the list of views, select the view to preview, and click **Preview**.
5. Open Plan responds by displaying the print preview window.
6. To return to the **Open Plan Web Publisher** dialog box, press **Alt+Tab**.

To run a report batch

1. Open the project containing the report batch you want to run.
2. On the **Tools** menu, click **Web Publisher**.
3. From the **Open Plan Web Publisher** dialog box, select the report batch, and click **Run**.

Open Plan produces the reports in the batch, using the output device specified in the **Open Plan Web Publisher** dialog box.

Defining Output Options

In addition to defining the views contained in a report batch, you can use the **Open Plan Web Publisher** dialog box to control the publication of the batch with the following settings:

- **Current Device** — The output device for the batch. If you specify an output device other than the Acrobat PDFWriter, you cannot enter information for the **Destination Directory**, **Generate HTML File**, and **Web Site Address** settings.



When producing a batch using an output device other than the Acrobat PDFWriter, the definition for that device in Windows determines if user intervention is required to produce each report in the batch.

- **Destination Directory** — The location of the directory for storing the .pdf files generated by the batch. Open Plan will also use this location for storing the HTML file (if created) as well as the .gif files for the various icons included in an HTML file. Clicking the **ellipsis** at the right edge of this field displays the **Destination Directory** dialog box that you can use to quickly select the target directory.
- **Generate HTML File** — Select this option if you want Open Plan to create an HTML file (file extension .htm) containing an inventory and links to the .pdf files created by the batch. If you choose to create this file, Open Plan stores it in the destination directory.
- **Web Site Address** — If you are generating an HTML file for the batch and want the URL links to include the address of a specific Web site, you can specify the address of the Web site with this setting. (If you do not specify the Web site address with this setting, you can still manually update the URL addresses contained in the HTML file produced by the batch.)

Working in a Multi-User Environment

Open Plan allows multiple users simultaneous access to project data. If you are using the Desktop edition of Open Plan, you can open project data in the **Exclusive** and **Read Only** modes; users of the Professional edition of Open Plan can open project data in the **Shared** mode as well.

The following sections discuss the three access modes used in Open Plan.

Opening Files

Each time you open a file in Open Plan using the **Open File** dialog box, you can select the access mode for the operation.

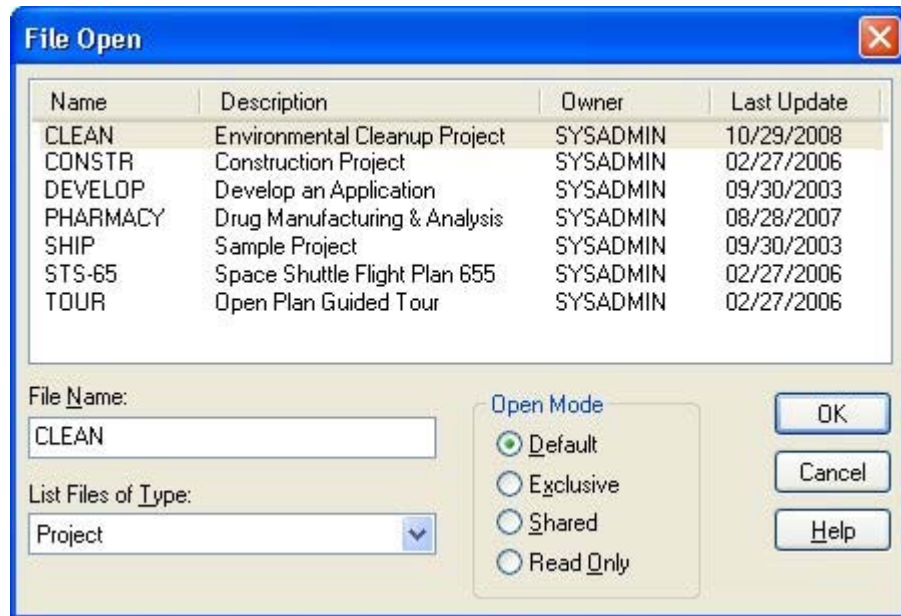

You use this dialog box to define the following settings:

- **File Name** — The name of the file to open. Select the file to open from the list displayed in the pane.
- **List Files of Type** — The type of files (project, calendar, resource, or code) displayed in the list.
- **Exclusive** — Opening a file in this mode puts a lock on the data preventing other users from being able to change the data. Other users can only open the file in **Read Only** mode.
- **Shared** — Opening a file in this mode allows multiple users to access and change the data of the file.
- **Read Only** — Opening a file in this mode allows you to only view the data and not make any changes.



The following sections provide more information on the three access modes.

When you select a file from the list, Open Plan indicates which modes are available for that file by enabling/disabling the appropriate selections. For instance:

- If you select a program that another user has opened in **Exclusive** mode, the **Exclusive** and **Shared** options are disabled (dimmed), and the **Read Only** option is active.
- If you select a file that another user has opened in **Shared** mode, the **Exclusive** mode is disabled, and the **Shared** and **Read Only** modes are active.
- If you select a file that another user has opened in **Read Only** mode, all three modes are active.

In some cases, however, it may be impossible for Open Plan to fulfill your request. This can happen if another user has opened the same file that you want between the time it takes you to you display the **File Open** dialog box and make your selection. Open Plan issues a warning when it cannot fulfill your request. For example, assume you display the **File Open** dialog box and select a project to open in **Exclusive** mode. Before you click **OK**, another user selects the same file to open in **Exclusive** mode and hits **OK**. Since the other user beat you to the punch, the project opens for him or her, and you receive a warning indicating that you cannot open the file.

When you open a project (regardless of the access mode you select), the auxiliary files associated with the project are opened in the default access mode established on the **Preferences** tab of the **Project Properties** dialog box. If you open an auxiliary file outside the context of a project, right-clicking the file and clicking **Default** on the **Open** submenu opens the auxiliary file in the default access mode established on the **Properties** dialog box for that file.

Working in the Exclusive Mode

If you open a file using the **Exclusive** mode, the file cannot be opened by other users except in the **Read Only** mode. In the **Exclusive** mode, changes are not saved to a file until you use either the **Save** or the **Save As** command. This means that you can abandon your changes at any time by simply closing the file without saving the information.



You cannot perform **Save As** on a file if there is another file open which refers to it. For example, if you open project CLEAN and then try to perform a **Save As** on the calendar file CLEANCAL, you are given the following warning: "Cannot perform Save As on Calendar File CLEANCAL because there are open objects referring to it." Since CLEAN refers to CLEANCAL, you need to close the project before you can perform **Save As** on CLEANCAL.

Working in the Shared Mode

If you are using the Professional edition of Open Plan, you can work with project data in the **Shared** mode. In this mode, it is possible for two or more users to access the data concurrently. To handle this situation, Open Plan uses an optimistic concurrency control approach that is based on the assumption that the probability of two users updating the same data item at the same time is relatively small.

If multiple users are updating the same set of records, it is possible that the information for a record has already been updated by another user. For example, assume you are updating project data using a dialog box. If you attempt to edit data that has already been changed by another user, Open Plan displays a

message to that effect and asks if you want to view the updated information for the item before continuing. If you click **Yes**, Open Plan displays the new information for the record and allows you to reenter your edit; if you click **No**, Open Plan returns you to the current view without saving any changes.

Because changes are saved to the file as you make them, the **Save** command is not available in the **Shared** mode. However, you can always use the **Save As** command to save the file under a different name.

In the **Shared** mode, user-entered data (for example, activity information or costs) is stored, but data calculated by Open Plan (for example, dates generated by time analysis or resource scheduling) is not stored. As a result, you must open the project in the **Exclusive** mode in order to save the results of a calculation.

In addition to calculated information, Open Plan does not allow you to save changes to information stored at the project level in the **Shared** mode. Thus, you cannot change the auxiliary files assigned to a project information

Working in the Read Only Mode

If you have opened a file in the **Read Only** mode, it is possible for other users to have access to the same file in any mode. If another user who has the file open in **Exclusive** or **Shared** mode makes changes to the information, you cannot see the effect of those changes unless you close the file and reopen it. Also, you cannot make any changes to the file while in this mode.

Setting the Default Access Mode

Although you can always select an access mode when opening a file from the **Open File** dialog box, it is also possible to open files from a context menu without displaying this dialog box. Right-clicking on a project folder or auxiliary file in the hierarchical view and pointing to **Open** on the context menu displays the following submenu:

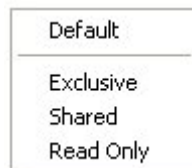

If the file has been opened by another user, the appropriate modes will be enabled or disabled on this submenu. You can open the file in its default access mode by clicking **Default**.



If you are using the Desktop version of Open Plan, the **Shared** mode is automatically disabled.

You can use the **Project Properties** dialog box to set the default access mode for a project and its auxiliary files when the project is opened in default mode. You can also use an auxiliary files **Properties** dialog box to set its default access mode when the file is opened outside the context of a project.

For a project, display the **Preferences** tab of the **Project Properties** dialog box:

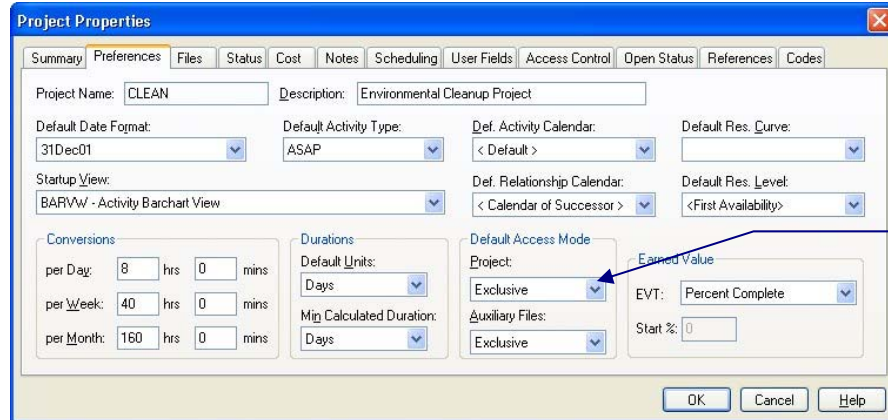

You can use the lists for the **Project** and **Auxiliary Files** fields to select the **Default Access Mode**.



If you are using the Desktop version of Open Plan, **Shared** mode is not available for selection from the **Project** or **Auxiliary Files** field list.

For a calendar, resource, and code file, display the **General** tab of the **Properties** dialog box:

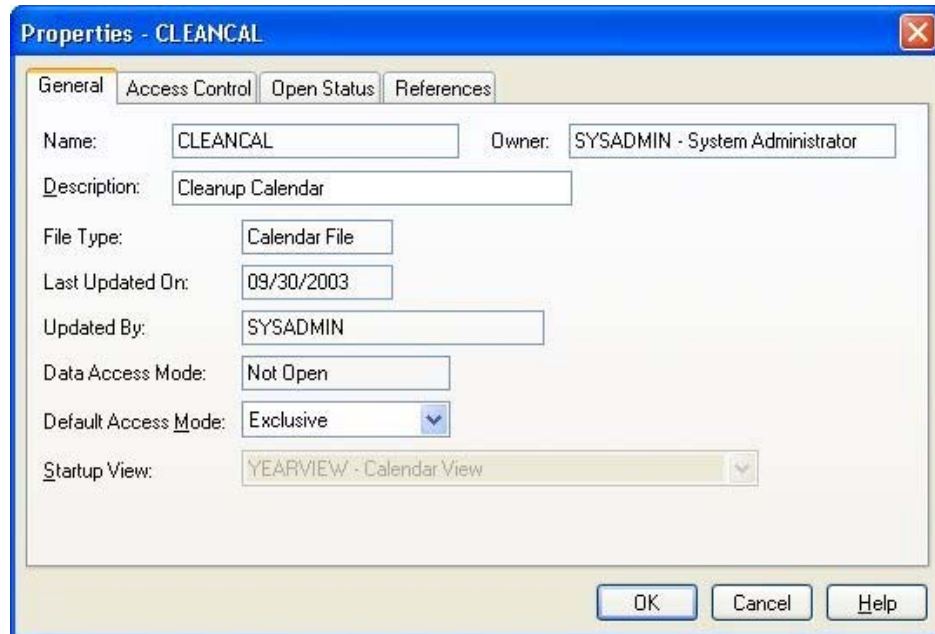

You can use the **Default Access Mode** list to select the new mode for the file.



If you are using the Desktop version of Open Plan, **Shared** mode is not available for selection from the **Default Access Mode** field list.

To set the default access mode for a project

1. In the Open Plan Explorer, select the project folder to which you want to change the default access mode.
2. Take one of the following actions:

- On the **Project** menu, click **Properties**.
 - Right-click the project folder, and click **Properties** on the context menu.
3. On the **Project Properties** dialog box, click the **Preferences** tab.
 4. Set the default access mode for **Project** and **Auxiliary Files**, and click **OK**.

To set the default access mode for a calendar, resource, or code file.

1. In the Open Plan Explorer, right-click the file to which you want to change the default access mode, and click **Properties** on the context menu.
Open Plan displays the **Properties** dialog box for that file.
2. On the **General** tab of the **Properties** dialog box, select a new mode from the **Default Access Mode** list.
3. Click **OK**.

25

System Defaults

➤ Overview	639
➤ System Options	640

Overview

Open Plan ships with standard system options defined. You can change these default settings at any time by using the **Options** dialog box.

This chapter discusses the different tabs of the **Options** dialog box.

System Options

You can set system-wide options in Open Plan by clicking **Options** on the **Tools** menu to display the **Options** dialog box. You can then navigate among the various tabs to set the system options for Open Plan.

To change system options

1. On the **Tools** menu, click **Options**.
2. Navigate the tabs and change the desired settings, and click **OK**.

The following sections describe each tab of the **Options** dialog box.

General Tab

On the **Tools** menu, click **Options**, and then click the **General** tab to display the following dialog box:

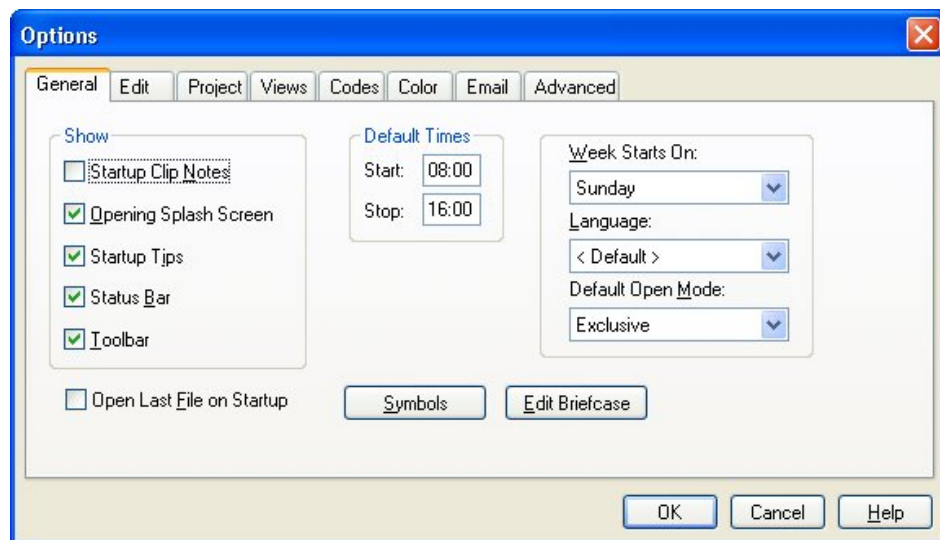

Use this tab to change the following system options:

- **StartUp Clip Notes** — You can control the automatic display of help information when opening an empty view.
- **Opening Splash Screen** — You can control the display of the opening splash screen when you start Open Plan.
- **Startup Tips** — You can control the display of the Tip of the Day window when you start Open Plan.
- **Status Bar** — You can control the display of the status bar along the bottom of the screen.
- **Toolbar** — You can control the display of the toolbar along the top of the screen.
- **Default Times** — These fields control the standard work day that Open Plan uses when you create a project using default settings. You can override this setting in the **New File Wizard**.



For more information on using the **New File Wizard**, refer to Chapter 4, “Creating a New File.”

- **Week Starts On** — The selection you make from this list controls the day of the week that Open Plan uses as the starting day of each work week.
- **Language** — You can specify the language used by Open Plan for dialog boxes, commands, and system messages.
- **Default Open Mode** — The selection you make here controls the default access mode Open Plan uses for a project when you create a project using default settings. You can override this setting in the **New File Wizard**.



For more information on using the **New File Wizard**, refer to Chapter 4, “Creating a New File.”

- **Open Last File on Startup** — You can have Open Plan automatically start with the last project or data file you opened in the previous session.
- **Symbols** — Clicking this button displays the **Manage Symbols** dialog box.



For more information on using the **Manage Symbols** dialog box, refer to Chapter 17, “Views and Reports.”

- **Edit Briefcase** — Clicking this button displays the **Edit Data Source** dialog box for the Briefcase data source. You can use this dialog box to make changes to your Briefcase data source.



For more information on using the **Edit Data Source** dialog box, refer to Chapter 24, “System Utilities.”

Edit Tab

On the **Tools** menu, click **Options**, and then click the **Edit** tab to display the following dialog box:

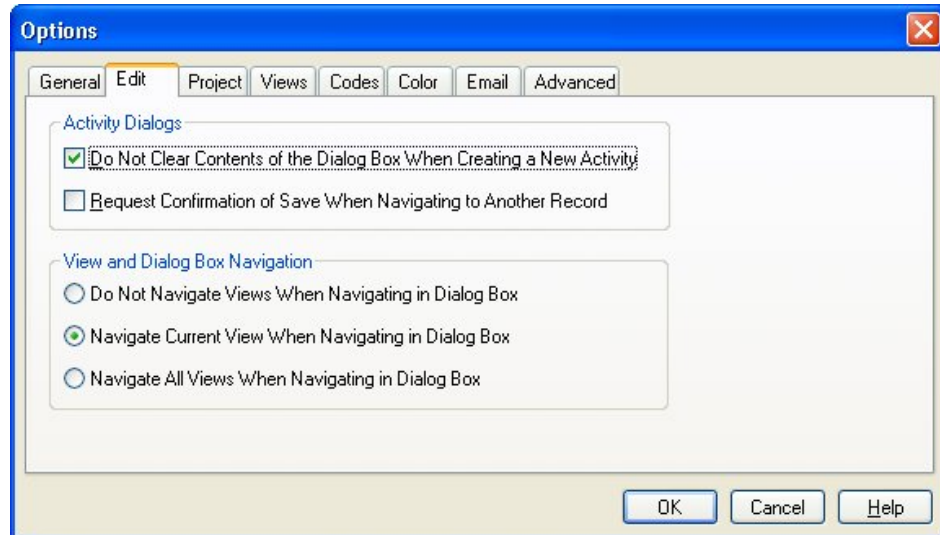

Use this tab to change the following system options:

- **Do Not Clear Contents of the Dialog Box When Creating a New Activity** — This option controls whether the contents of a dialog box are cleared when you create a new activity:
 - If this option is selected, Open Plan does not remove the existing contents of an **Activity Details** dialog box when you create a new activity. This effectively copies the data to the new activity.
 - If this option is cleared, the dialog box that is displayed when you create a new activity is empty. This is the default.
- **Request Confirmation of Save When Navigating to Another Record** — This option controls whether Open Plan should generate a message asking you to confirm that you want your changes saved when you navigate to another record:
 - If this option is selected, Open Plan issues a message when you navigate to another record that asks you whether you want your changes saved.
 - If this option is cleared, Open Plan saves your changes without asking you to confirm the action. This is the default.

You can also control how Open Plan should synchronize modeless dialog boxes with views using the following options:

- **Do Not Navigate Views When Navigating in Dialog Box** — Selecting this option instructs Open Plan not to navigate the open views when clicking the navigation buttons in a dialog box.
- **Navigate Current View When Navigating in Dialog Box** — Selecting this option instructs Open Plan to navigate the open view that has focus when clicking the navigation buttons in a dialog box. For example, assume you have a barchart view and a spreadsheet view open. Also assume that you display the **Activity Details** dialog box for an activity from the spreadsheet view. Since the spreadsheet view has focus, when you use the navigation buttons in the

dialog box to display another activity, the new activity will automatically be highlighted in the spreadsheet view but not the barchart view.

- **Navigate All Views When Navigating in Dialog Box** — Selecting this option instructs Open Plan to navigate all open views when clicking the navigation buttons in a dialog box. For example, assume that you have a barchart view and a spreadsheet view open and you display the **Activity Details** dialog box for an activity. Using the navigation buttons in the dialog box to display another activity will automatically highlight the new activity in the two open views.

Project Tab

On the **Tools** menu, click **Options**, and then click the **Project** tab to display the following dialog box:

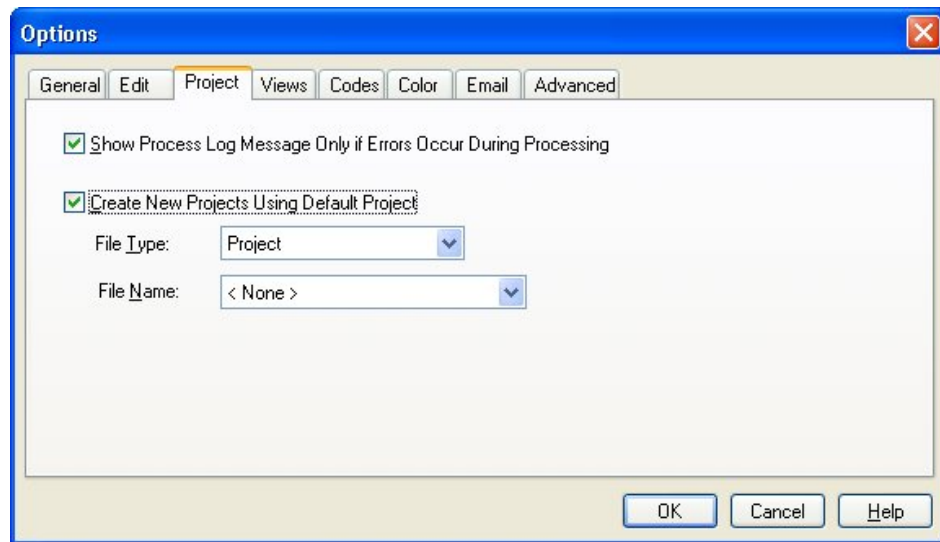

Use this tab to change the following system options:

- **Show Process Log Message Only if Errors Occur During Processing** — This option controls whether you are always prompted to view a log produced by operations such as time analysis and resource scheduling.
 - If this option is selected, Open Plan prompts you to view the operation log only if errors occur during processing. This is the default setting.
 - If this option is cleared, Open Plan always prompts you to view the operation log regardless of whether errors occurred during the process.
- **Create New Project Using Default Project** — This option controls whether new projects are created as copies of a default project.
 - If this option is selected, Open Plan opens the default project when you create a new project. After you have entered information for the new project, you can save your changes using the **Save As** command on the **File** menu.

Selecting this option enables two fields:

- **File Type** — Select Project or Project Template
- **File Name** — Select the file name from the list

If the **Create New Project Using Default Project** option is cleared, Open Plan does not open a default project when you create a new project.

Views Tab

On the **Tools** menu, click **Options**, and then click the **Views** tab to display the following dialog box:

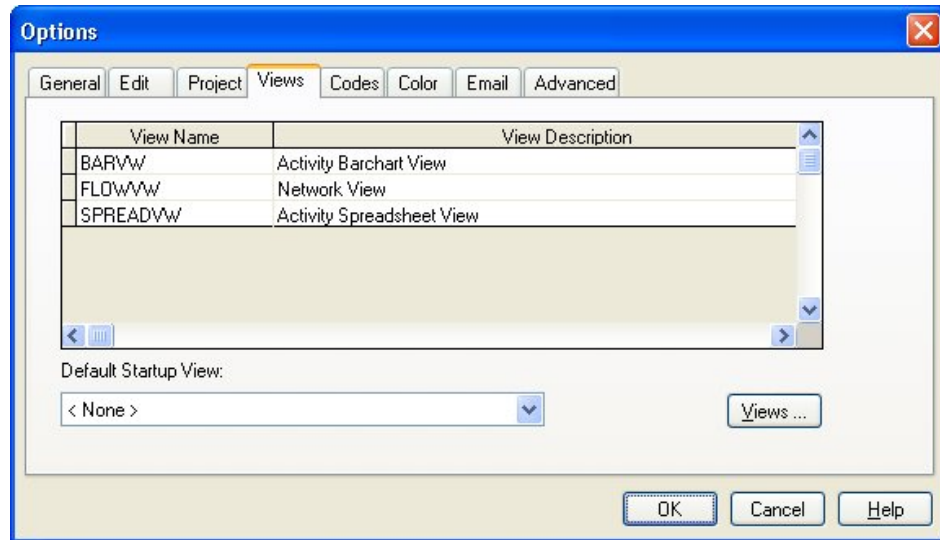

The top half of the **Views** tab is a grid that lists the views that will automatically be assigned when a new project is created. These views are selected using the **Views** button.

This tab also includes the following controls:

- **Default Startup View** — This field contains a list of the currently defined standard views that are displayed in the grid. You can select a view from this list to instruct Open Plan to display that view by default whenever the project is opened.
- **Views** — If you click this button, Open Plan displays the **Select Standard Views** dialog box that you can use to specify which view(s) Open Plan should automatically assign to a newly created project:

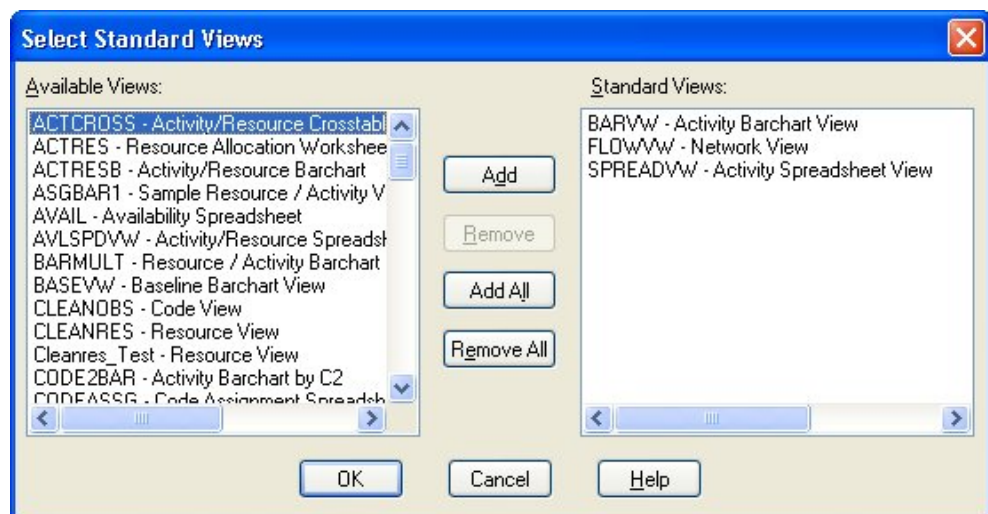

To add a view to the Standard Views list

1. On the **Tools** menu, click **Options**.
2. On the **Views** tab of the **Options** dialog box, click **Views**
3. Open Plan displays the **Select Standard Views** dialog box.
4. From the **Available Views** list, select a view, and click **Add**.



You can select more than one view at a time and click **Add** to move all of them to the **Standard Views** list at once.

If you are adding all the views from the list, you can click **Add All** without having to first select the views.

5. When finished, click **OK**.

To remove a view from the Standard Views list

1. On the **Tools** menu, click **Options**.
2. On the **Views** tab of the **Options** dialog box, click **Views**
3. From the **Standard Views** list, select a view, and click **Remove**.



You can select more than one view at a time and click **Remove** to move all of them to the **Available Views** list at once.

If you are removing all the views from the list, you can click **Remove All** without having to first select the views.

4. When finished, click **OK**.

Codes Tab

On the **Tools** menu, click **Options**, and then click the **Codes** tab to display the following dialog box:

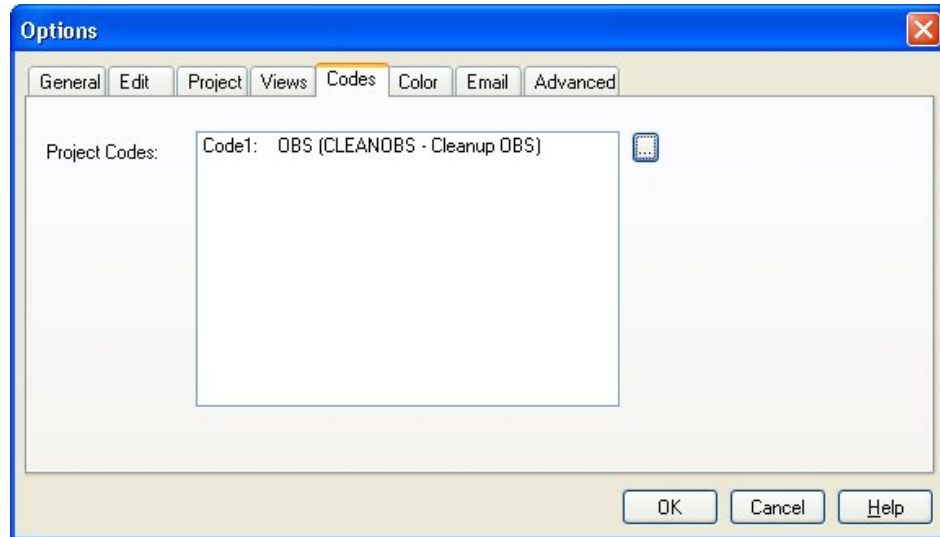

The **Codes** tab of the **Options** dialog box allows you to specify project-level code files that Open Plan should automatically assign to all projects.

Project-level code files might represent entities such as geographic region, client, business objective, division or other project-level reporting values.

Once codes have been specified on this tab of the **Options** dialog box, you can use the **Codes** tab on the **Project Properties** dialog box to assign values to the code fields.

The **Project Codes** text box displays the following information about each currently assigned code file:

- The code field to which the code file is assigned
- The prompt associated with the code file
- The code file name

The **ellipsis** button provides access to the **Assign Code** dialog box that you can use to assign code files to code fields and to specify a prompt for each code file.

Color Tab

On the **Tools** menu, click **Options**, and then click the **Color** tab to display the following dialog box:

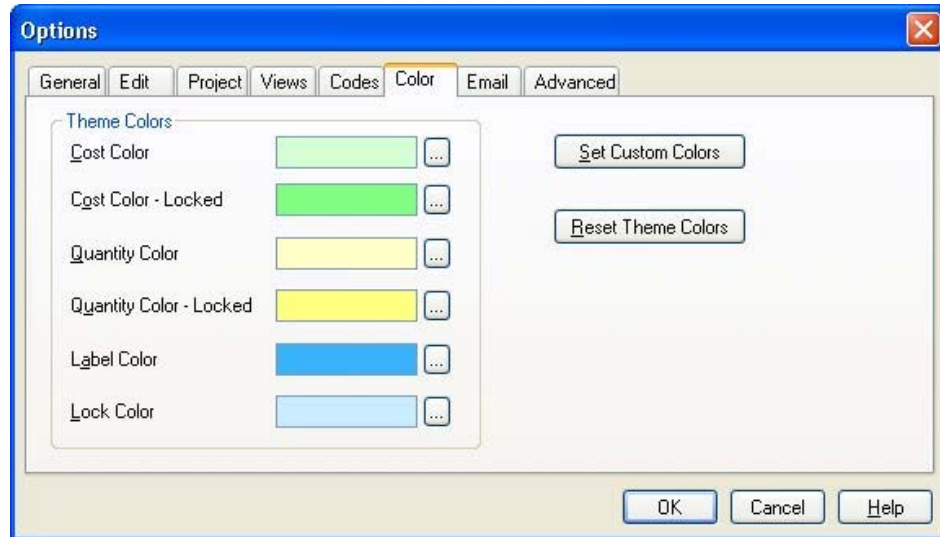

Use this tab to change the following system options:

- **Theme Colors** — You can set the color for each field by clicking its **ellipsis** button to display the **Color** dialog box:



You can use this dialog box to select a new color for the field.



Notice that the **Define Custom Colors** button is disabled. You can only add to the custom colors by using the **Set Custom Colors** option.

- **Set Custom Colors** — This button displays the same **Color** dialog box as above but with the **Add Custom Colors** button is enabled:

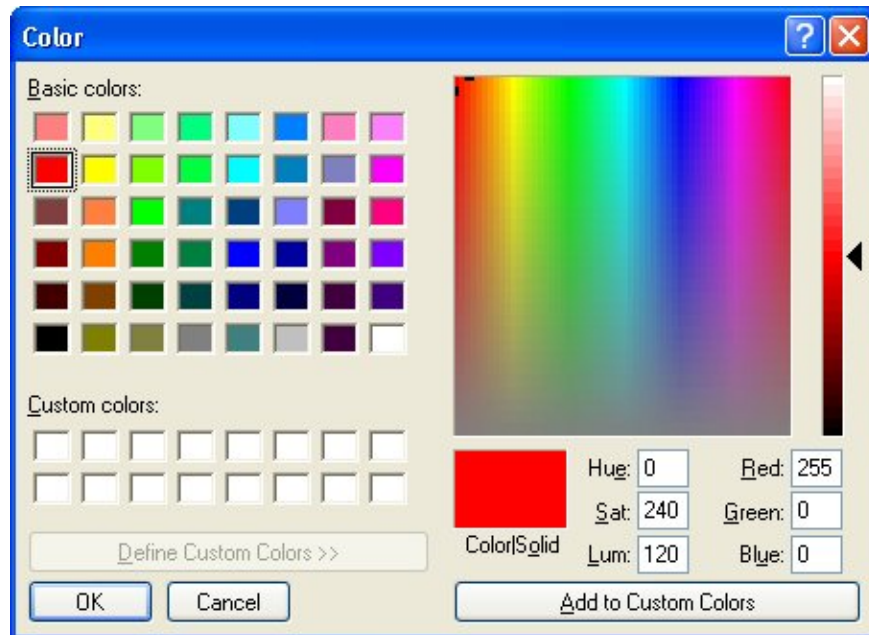

You can add custom colors with this dialog box, which then become available for selection when you click the **ellipsis** buttons next to the **Theme Colors** fields.

- **Reset Theme Colors** — This button resets the colors of the fields to the Open Plan default colors.

Email Tab

On the **Tools** menu, click **Options**, and then click the **Email** tab to display the following dialog box:

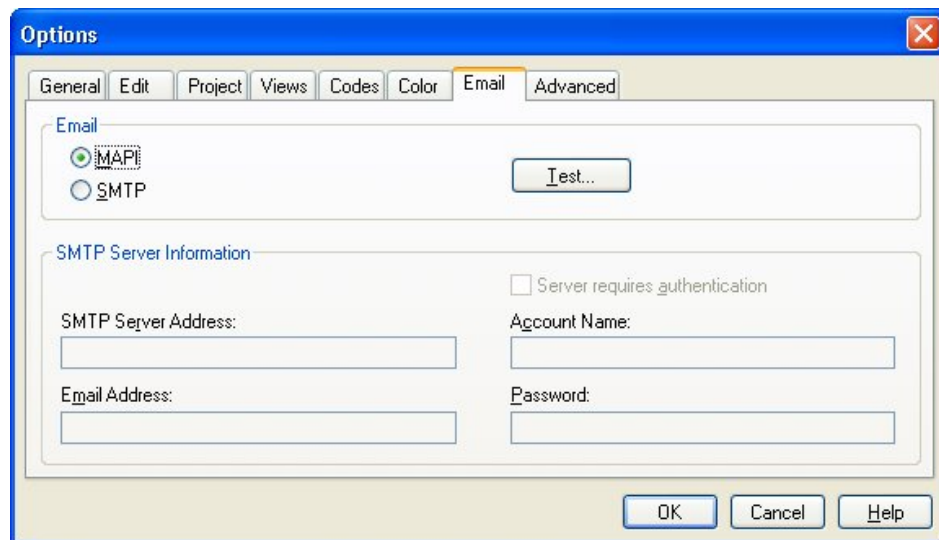

The **Email** tab of the **Options** dialog box allows the system administrator to configure email alerts to use either **MAPI** or **SMTP** to transmit email. The Email tab contains two sections: Email and SMTP Server Information.

Email

There are two email options available:

- MAPI
- SMTP

By default, the **MAPI** option is selected. When **MAPI** is selected, the controls in the **SMTP Server Information** group box are disabled. When the **SMTP** option is selected, the controls in the **SMTP Server Information** group box are enabled.

- Test

When the **Test** button is selected and the **MAPI** option is selected, the message page provided by the default system **MAPI** provider is invoked:

- The Subject text defaults to the string **Test**.
- The Body text defaults to the string **This is a test message**.
- If the test message is sent, a message box indicating success or failure is displayed after the message is sent.

When the **Test** button is selected and the **SMTP** option is selected, Open Plan attempts to connect to the SMTP server using the settings specified in the **SMTP Server Information** group box.

- If the connection to the SMTP server is successful, the SMTP Message dialog is displayed.
- If the connection to the SMTP server is not successful, an error message is displayed.

The **Test** button is always enabled.

SMTP Server Information

The following options are available for SMTP Server Information configuration:

- **SMTP Server Address** — SMTP Server Address stores the address of the SMTP Server.
- **Email Address** — Email Address stores a default sender email address.

The Email Address supports the use of the replaceable parameters `%WINUSERNAME%` and `%OPPUSERNAME%` to allow for simplified deployment scenarios (for example, [%WINUSERNAME%@deltek.com](#)).

If the Email Address is left blank, Open Plan will attempt to obtain the email address associated with the Open Plan User ID.

The maximum length of the user name portion of the email address cannot exceed 64 characters and the domain name portion of the email address should not exceed 255 characters.

- **Server requires authentication** — By default, the Server requires authentication checkbox is not selected.

The Account Name and Password controls are disabled when the Server requires authentication option is not selected.

- **Account Name** — Account Name allows the user to enter an SMTP server account name if required by the SMTP server.

There are no limits on the length of the server account name.

- **Password** — Password allows the user to enter a SMTP server password if required by the SMTP server.

There are no limits on the length of the server password.

Advanced Tab

On the **Tools** menu, click **Options**, and then click the **Advanced** tab to display the following dialog box:

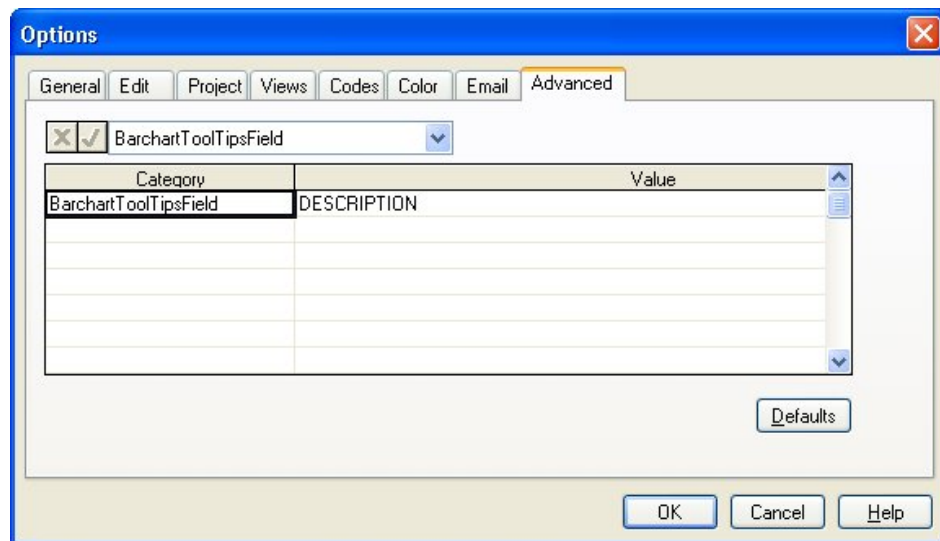

This tab allows you to specify the predefined options you want enabled. The options that you enable are stored in the **User Preferences** table.

For example, selecting the **BarchartToolTipsField** from the **Category** list and defining a single field as the **Value** allows you to define text to be displayed as a Tool Tip for the barchart. This category requires that you enter a single field as the **Value**. However, in addition to allowing you to enter a standard field, Open Plan also allows you to specify a calculated field that contains exactly the information that you want displayed.



For more information on calculated fields, refer to Chapter 23, "Project Utilities."

A **Defaults** button displays the **System Preferences Defaults** dialog box that a system administrator can use to define system-wide preferences from which a user can select.

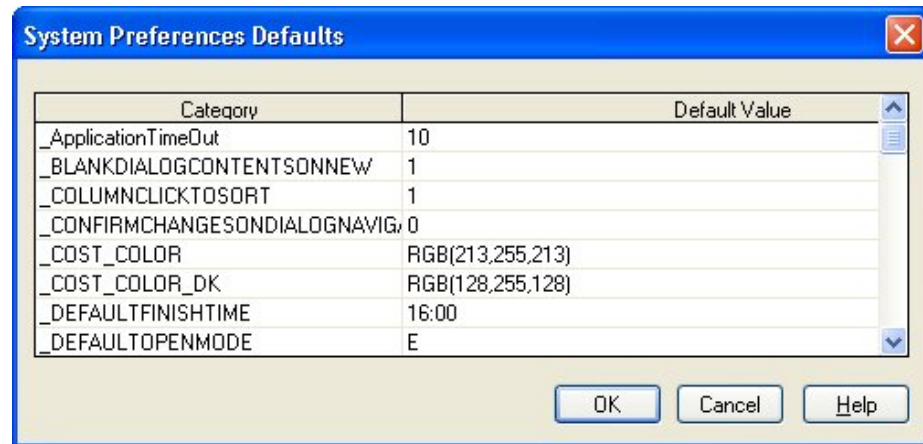

The entries that the system administrator makes in this dialog box are stored in the **System Preferences Default** table.



In previous versions of Open Plan, the settings on this tab of the **Options** dialog box were set by entries in the .ini file.

The following is a list of standard Open Plan options:

- _ALLOW_EDIT_READONLY
- _ApplicationTimeOut
- _BLANKDIALOGCONTENTSONNEW
- _CONFIRMCHANGESONDIALOGNAVIGATION
- _COPY_ACL_ON_SAVEAS
- _COST_COLOR
- _COST_COLOR_DK
- _DEFAULTFINISHTIME
- _DEFAULTOPENMODE
- _DEFAULTSTARTTIME
- _LABEL_COLOR
- _LOCK_COLOR
- _LOGVIEWTHRESHOLD
- _NOTIFICATIONPOLLINGINTERVAL
- _OPENLASTFILE
- _QTY_COLOR
- _QTY_COLOR_DK
- _SPLASHSCREENENABLE
- _STATUSBAR
- _SUPPRESSEMPYCLIPNOTE

- `_SUPPRESSLOOPDETECTION`
- `_SYNCDIALOGNAVIGATION`
- `_TIPSTARTUP`
- `_TOOLBAR`
- `_USEDEFAULTPROJECT`
- `ALLOWACTIVEXINBROWSERVIEW`
- `ALLOWSCRIPTINBROWSERVIEW`
- `ALLOWZEROBASELINEUSAGE`
- `BARCHARTTOOLTIPSFIELD`
- `BARPRINTMODE`
- `CALCOMPFIX`
- `HISTOGRAMARRAYLIMIT`
- `RISKPERCENTILEARRAYSIZE`
- `SHOWSQLLOG`
- `SUPPRESSCOMBINEVERTICALS`



Option settings displayed on the Advanced tab of the Options dialog are specific to the user who defines them.

Option settings displayed in the System Preferences Defaults dialog apply to all users and can be set only by someone with system administrator rights.

`_Allow_Edit_ReadOnly`

When you open read-only files within Open Plan, this option allows you to make changes to these files and save them using a new name, preserving the original read-only file. There are two settings:

0 = Do not allow modifications to read-only files.

1 = Enable users to modify read-only files, saving under a different name.

Because the process of applying this option differs from the way the predefined options are applied, the process is listed below:

To Set Edits to Read-only Files

1. From the **Tools** menu, select **Options**.
2. On the **Options** dialog, select the **Advanced** tab.
3. Choose the **Defaults** button.
4. Scroll to the end of the grid.
5. Enter the value `_ALLOW_EDIT_READONLY` in the **Category** column.
6. Enter the desired numeric value in the **Default Value** column.
7. Click **OK** to dismiss the **System Preferences Defaults** dialog.
8. Click **OK** to dismiss the **Options** dialog.

_ApplicationTimeOut

This option is used to set the amount of notice given to users (in seconds) whose sessions are about to be terminated. The default period of time for notification is 10 seconds.

_BLANKDIALOGCONTENTSONNEW

This option controls the display of the contents of a dialog. There are two settings:

- 0** = Blanks out the contents of the dialog when the user presses the New button.
- 1** = Leaves the existing contents of the dialog when the user presses New, effectively copying the data to the new activity.

The default setting is 1.

_CONFIRMCHANGESONDIALOGNAVIGATION

This option makes Open Plan display a confirmation message to save changes when the user presses a navigation button or closes a modeless dialog through the Windows Close button (X). There are two settings:

- 0** = Does not display a confirmation message.
- 1** = Displays a confirmation message.

The default setting is 0.

_Copy_ACL_On_SaveAs

This option allows access control information to be copied when Save As is used to save a file. There are two settings:

- 0** = Do not copy access control lists when performing a Save As.
- 1** = Copy access control lists when performing a Save As.

The default setting is 1.

Because the process of applying this option differs from the way the predefined options are applied, the process is listed below:

To Enable the Option to Copy Access Control Lists When Performing a Save As

1. From the **Tools** menu, select **Options**.
2. On the **Options** dialog, select the **Advanced** tab.
3. Choose the **Defaults** button.
4. Scroll to the end of the grid.
5. Enter the value **_COPY_ACL_ON_SAVEAS** in the Category column.
6. Enter the value **1** in the **Default Value** column.
7. Click **OK** to dismiss the **System Preferences Defaults** dialog.
8. Click **OK** to dismiss the **Options** dialog.

_COST_COLOR

This holds the RGB value of the Cost Color setting.

__COST_COLOR_DK

This holds the RGB value of the Locked setting.

__DEFAULTFINISHTIME

Allows the user to specify a default time to be added to finish dates that are entered without a specified time. The format of the time is HH:MM. The default setting is 16:00.

__DEFAULTOPENMODE

This option controls the default mode for File | Open. This option also sets the default access mode for new projects. Shared access is not supported by Open Plan Desktop. If the user specifies Shared, OP Desktop substitutes Exclusive. There are three modes:

1 = Exclusive.

2 = Shared.

3 = Read Only.

The values are **E**, **S**, and **R**. The default setting is **E**.

__DEFAULTSTARTTIME

Allows the user to specify a default time to be added to start dates that are entered without a specified time. The format of the time is HH:MM. The default setting is 08:00.

__LABEL_COLOR

This holds the RGB value of the Label Color setting.

__LOCK_COLOR

This holds the RGB value of the Lock Color setting.

__LOGVIEWTHRESHOLD

This option controls when the user is prompted to view messages produced by operations such as time analysis and resource scheduling. There are two settings:

0 = Always prompt to view messages – regardless of severity.

1 = Only prompt to view messages when error messages have been generated.

The default setting is 1.

__NOTIFICATIONPOLLINGINTERVAL

This option controls how often (in seconds) Open Plan checks to see if the session has been terminated or if there are any new messages. Note that this is an application-wide setting that will affect all users. The default setting is 10 seconds.

__OPENLASTFILE

This option controls whether the last file used is opened on start-up. There are two settings:

0 = Does not open the last file used on start up.

1 = Opens the last file used on start up.

The default setting is 0.

_QTY_COLOR

This holds the RGB value of the Quantity Color setting.

_QTY_COLOR_DK

This holds the RGB value of the Quantity Color – Locked setting.

_SPLASHSCREENENABLE

This option controls the display of the Open Plan splash screen at start-up.

0 = Disables the splash screen.

1 = Enables the splash screen.

The default setting is 1.

Because the process of applying this option differs from the way the predefined options are applied, the process is listed below:

To Set the Splash Screen

1. From the **Tools** menu, select **Options**.
2. On the **Options** dialog, select the **Advanced** tab.
3. Choose the **Defaults** button.
4. Scroll to the end of the grid.
5. Enter the value **_SPLASHSCREENENABLE** in the **Category** column.
6. Enter the desired numeric value in the **Default Value** column.
7. Click **OK** to dismiss the **System Preferences Defaults** dialog.
8. Click **OK** to dismiss the **Options** dialog.

_STATUSBAR

This option controls the display of the Open Plan status bar.

0 = Hide Open Plan status bar.

1 = Show Open Plan status bar.

The default setting is 1.

_SUPPRESSEMPYCLIPNOTE

A clip note is a help item that comes up when you create a new project, pool, calendar, code, or view within Open Plan. This option allows the display of these help items to be suppressed.

0 = Open Plan displays the clip notes.

1 = Open Plan does not display the clip notes.

The default setting is 1.

_SUPPRESSLOOPDETECTION

This option allows full automatic loop detection in Open Plan to be turned off (by setting a value of 0) or restricted (by setting a value less than the total number of activities) for large networks or networks with large numbers of complex relationships. Full loop detection will still be performed during Time Analysis.

The default value for `_SUPPRESSLOOPDETECTION` is 1000. The number is a threshold value that determines at what point loop detection will be turned off. Thus, for the default value of 1000, loop detection is enabled as long as the total number of activities does not EXCEED 1000.

_SYNCDIALOGNAVIGATION

This option controls whether the modeless dialogs are synchronized when the user displays another record by pressing a navigation button on the dialog. The Open Plan setup program automatically enables this option.

0 = Does not synchronize the dialogs.

1 = Synchronizes the navigation of the dialogs.

The default setting is 1.

_TIPSTARTUP

This option controls whether the Tips dialog is displayed on startup.

0 = Does not display tips on startup.

1 = Displays tips on startup.

The default setting is 1.

Because the process of applying this option differs from the way the predefined options are applied, the process is listed below:

To Set the Tips Dialog

1. From the **Tools** menu, select **Options**.
2. On the **Options** dialog, select the **Advanced** tab.
3. Choose the **Defaults** button.
4. Scroll to the end of the grid.
5. Enter the value `_TIPSTARTUP` in the **Category** column.
6. Enter the desired numeric value in the **Default Value** column.
7. When finished, click **OK** to close the **System Preferences Defaults** dialog.
8. Click **OK** to close the **Options** dialog.

_TOOLBAR

This option controls the display of the Open Plan toolbar.

0 = Hide Open Plan Toolbar.

1 = Show Open Plan Toolbar.

The default setting is 1.

_USEDEFAULTPROJECT

This option specifies whether the template project specified in DefaultProjectName should be used when creating new projects.

0 = Do not use template project to create new projects.

1 = Use template project when creating new projects.

The default setting is 0.

AllowActiveXInBrowserView

When you view a Web page locally from within Open Plan, this option allows the local page to access OLE objects and ActiveX controls without issuing a warning.

0 = A warning is issued if the local page contains OLE objects and/or ActiveX controls. You are also prompted as to whether or not you want to allow the interaction for this Web page.

1 = OLE objects and ActiveX controls are allowed without issuing a warning.



If you link to a page outside the local zone, this setting no longer applies, and your browser's default security takes over.

AllowScriptInBrowserView

When you view a Web page locally from within Open Plan, this option allows the local page to run scripts without issuing a warning.

0 = A warning is issued if the page contains scripts.



It is possible that your browser is already configured to run scripts without first issuing a warning. If this is the case, setting this option to 0 does not override the browser setting.

1 = No warning is issued if the page contains scripts.



If you link to a page outside the local zone, this setting no longer applies, and your browser's default security takes over.

AllowZeroBaselineUsage

This option helps with Cobra integration by allowing Open Plan to save a zero to the Baseline Usage table for a resource. To enable this option, select **AllowZeroBaselineUsage** from System Preferences Defaults table and set the default value to 1.

BarchartToolTipsField

This option allows you to define text to be displayed as a Tool Tip for the barchart. It requires that you enter a single field as the **Value**. However, in addition to allowing you to enter a standard field, Open Plan also allows you to specify a calculated field that contains exactly the information that you want displayed.

The default value is **Description**.



For more information on calculated fields, refer to Chapter 23, "Project Utilities."

BarPrintMode

This option is used to correct problems on certain devices when drawing barchart views that contain bars that use hatch patterns.

0 = Use normal bar drawing method. This is the default setting.

1 = Use alternate bar drawing method.

CalCompFix

This option prevents Open Plan from printing segmented bars which are known to cause problems with certain Calcomp plotter drivers due to a problem with the driver support of the GDI Polygon function. This eventually results in a general protection fault in Open Plan.

0 = Print segmented bars. This is the default setting.

1 = Do not print segmented bars.

HistogramArrayLimit

This option defines the maximum number of array elements in the histogram. Each array element represents a time unit as defined by the date scale of the view.

Valid values are 1000 – 15000. The default value is **3000**.

RiskPercentileArraySize

This option is used to specify the size of the array used to store percentile values for key activities during risk analysis.

Valid values are 5 – 1000. The default value is **21**.

ShowSQLLog

This option allows you to view the SQL Log in the Open Plan Log Viewer. The log is created when you start your Open Plan session and is automatically updated whenever the database is accessed.

0 = The log is not displayed in the Open Plan Log Viewer. This is the default setting.

1 = The log is displayed in the Open Plan Log Viewer on the **SQL Log** tab.



If you wish to view the SQL Log outside the context of Open Plan, you can use any text editor (such as Windows Notepad) to open the *sql.log* file located in the \User directory of your Open Plan installation.

SuppressCombineVerticals

By default, when performing automatic placements, Open Plan combines vertical relationship lines when showing relationships using the **Routed** line style as in the following example:

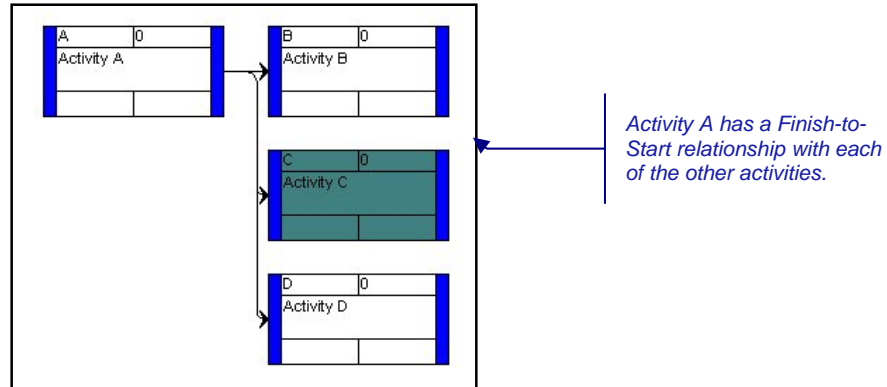

The **SuppressCombineVerticals** option instructs Open Plan to display each relationship line separately:

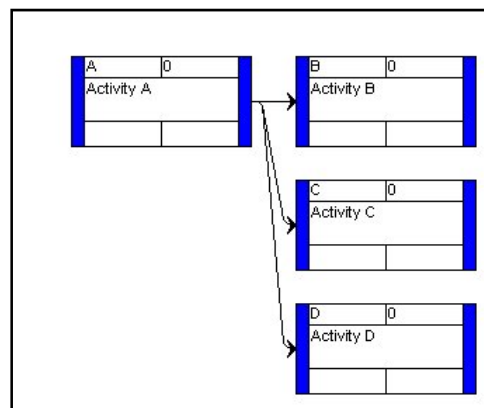

0 = Open Plan combines vertical relationship lines. This is the default setting.

1 = Open Plan suppresses the combining of vertical relationship lines.

The following options are no longer used by Open Plan:

_COLUMNCLICKTOSORT

This option is no longer used. The setting is stored in each individual view.

_DISPLAYSTATUSVIEWER

This setting is no longer used.

Appendix A - Glossary

Activity	<p>The smallest self-contained unit of work used to define the logic of a project.</p> <p>In general, activities share the following characteristics:</p> <ul style="list-style-type: none"> ▪ They have a definite start and finish date. ▪ They may have logical relationships to other activities in a project. ▪ They use resources such as people, materials, or facilities. ▪ They have an associated cost.
Activity File	The data tables corresponding to the ACT file in other versions of Open Plan.
Activity ID	A unique code identifying each activity in a project.
Activity Status	<p>The state of completion of an activity:</p> <ul style="list-style-type: none"> ▪ Planned — The activity has not yet started. ▪ In Progress — The activity is in progress. ▪ Complete — The activity is complete.
Actual Cost of Work Performed (ACWP)	The actual cost expended on an activity, a part of a project, or an entire project.
Actual Finish	The date on which an activity was completed.
Actual Start	The date on which an activity was started.
Alternate Resource	<p>A resource that Open Plan may substitute for an activity requirement during resource scheduling, if the requested resource is not available. An alternate resource may be an individual, a pool, or a skill.</p>
As-Late-As-Possible (ALAP)	An activity for which Open Plan sets the early dates as late as possible

	without delaying the early dates of any successor.
As-Soon-As-Possible (ASAP)	An activity for which Open Plan sets the early dates to be as soon as possible. This is the default activity type.
Assignment Profile Curve	A profile that describes how a resource assignment is spread through the duration of an activity. Open Plan provides seven standard assignment profile curves: back load, double peak, early peak, front load, late peak, linear, and normal (bell).
Asymmetrical Distribution	A probability distribution not symmetrical about its central tendency. Same as skewed distribution.
Average	A measure of central tendency of a sample or a probability distribution, obtained by adding the individual values in a sample and dividing by the sample size. Same as mean or expected value.
Backward Pass	A procedure within time analysis to calculate the late start and late finish dates of all activities in a project.
Barchart View	A view that uses horizontal bars on a time scale to depict activity information. In Open Plan, a barchart view is a composite view that displays an activity barchart, a spreadsheet, and, if resources are assigned to the project, a histogram. A barchart is frequently called a Gantt chart.
Baseline	A copy of the project data for baseline comparison use.
Beta Distribution	A family of continuous probability distributions in which the random variable varies in the range of 0 to 1 and with a skew and kurtosis (“peakedness”) that depends on a pair of parameters. In the context of Open Plan, the definition of the beta distribution has been expanded to allow random variables distributed

	between any pair of user-specified values, instead of always between 0 and 1.
Breakdown Structure	A hierarchical, validated structure for codes that allows you to summarize project data for reporting requirements.
Budget	The planned cost for an activity or project.
Budget at Completion (BAC)	The sum total of the time-phased budget.
Budgeted Cost of Work Performed (BCWP)	A measure used in cost control that allows you to quantify the overall progress of the project in monetary terms. BCWP is calculated by multiplying the physical percent complete by the planned cost. Another term for BCWP is “earned value.”
Budgeted Cost of Work Scheduled (BCWS)	Planned cost multiplied by the percentage of completion that should have been achieved according to the project baseline dates.
Calendar	A definition of valid working periods for a group of project activities.
Calendar File	A file containing calendar information for one or more calendars.
Central Tendency	The central area of a probability distribution, usually corresponding to the mode (“most likely”) or mean (“average”) value of the random variable. Most of the results of Open Plan processing use the mean to measure central tendency.
Child	A lower-level element in a hierarchical structure.
Code File	A file used in reporting that contains information associated with codes entered on an activity record or a resource record.
Confidence	The likelihood of a statistical deduction from empirical data. Confidence is usually expressed as a percentage and applied to a range of possibilities. See also Confidence Interval.

Confidence Interval	A pair of values bracketing an estimate (usually derived from sampled data), indicating that there is some stated percentage probability that the true value falls within that range. For example, a 99% confidence interval would be a pair of values such that there was a 0.5% chance of the true value being less than the lower value, and a 0.5% chance that the true value is above the higher value.
Consumable Resource	A type of resource that remains available until consumed (for example, a material).
Controlling Relationship	A relationship that controls the early date of the successor activity. In Open Plan, a controlling relationship can be detected by its free float being zero.
Cost Variance (CV)	The difference between the budgeted and actual cost of work performed.
Critical Activity	An activity is termed critical when it has zero or negative float.
Critical Path	Series of consecutive activities that represent the longest path through the project.
Criticality Index	In Open Plan, a measure of the probability that a particular activity is on the critical path of a project. Expressed as a percentage.
Cumulative Distribution	The representation of a probability distribution as a cumulative curve. Each point on the curve represents the probability that the random variable will be no greater than the value represented by that point. By definition, the height of such a curve must be non-decreasing, starting at zero and increasing to one.
Default Calendar	If no user-created calendar file is associated with the project, the default calendar is used for date calculations. The default calendar is defined as Monday through Friday, 8 A.M. to 4 P.M., and no holidays.

Delaying Resource	<p>In resource scheduling, inadequate availability of one or more resources may require that the completion of an activity be delayed beyond the date on which it could otherwise be completed.</p> <p>The delaying resource is the first resource on an activity that causes the activity to be delayed.</p>
Discontinuous Activity	<p>An activity in which the interval between the start and finish dates is allowed to exceed its duration in order to satisfy start-to-start and finish-to-finish relationships with other activities.</p>
Distribution	<p>See Probability Distribution.</p>
Duration	<p>The number of working periods required to perform the work represented by an activity. In risk analysis, this corresponds to “most likely” duration.</p>
Earliest Feasible Date	<p>The earliest date on which the activity could be scheduled to start based on the scheduled dates of all its predecessors, but in the absence of any resource constraints on the activity itself. This date is calculated by resource scheduling.</p>
Early Dates	<p>Calculated in the forward pass of time analysis, early dates are the earliest dates on which an activity can start and finish.</p>
Early Finish	<p>The earliest date on which an activity can finish. This date is calculated by time analysis.</p>
Early Start	<p>The earliest date on which an activity can start. This date is calculated by time analysis.</p>
Earned Value Cost Control	<p>An approach to project cost control that quantifies the overall progress of the project in monetary terms. Earned value is calculated by multiplying the physical percent complete by the planned cost. Another term for earned value is budgeted cost of work</p>

	performed (BCWP).
End Activity	An activity with no logical successors. Also known as a finish activity.
Escalation	A feature that allows you to specify different resource unit costs and the date on which each new cost takes effect.
External Subproject	A complete project represented as a single activity in a higher-level project.
Extra Work Day	An exception to the standard non-working day. For example, assume that a calendar defines Monday through Friday as days on which work is normally performed. In this case, a specific Saturday might be identified as an extra work day if work is to be performed on that day.
Finish Activity	An activity that has no successor. Also known as an end activity.
Finish Float	The number of work periods between the early finish date and the late finish date.
Finish Milestone	A milestone activity signifying the end of a project phase.
Finish-to-Finish Relationship	<p>The relationship between activities that specifies that the finish of the successor activity depends on the completion of the predecessor activity.</p> <p>In most cases, this means that the successor activity cannot be completed before the predecessor activity is completed.</p>
Finish-to-Start Relationship	<p>The relationship between activities that specifies that the start of the successor activity depends on the completion of the predecessor activity.</p> <p>In most cases, this means that the successor activity cannot start until the predecessor activity is completed. This is the default relationship.</p>
Fixed Format Significant Coding Structure	A coding structure that relies on the length of the code to represent the

	hierarchical level.
Float	The number of time periods by which an activity can be delayed without affecting other activities in a project.
Foreign Activity	A placeholder activity used to represent relationships with projects that are not currently open.
Forward Pass	A procedure within time analysis to determine the early start and early finish dates of activities.
Free Float	The maximum amount by which an activity can be delayed beyond its early dates without delaying any successor activity beyond its early dates. In the absence of finish targets, free float is always less than or equal to total float.
Hammock	An activity that plays no part in time analysis, but which provides the means to report on the start and finish of a group of activities.
Hard Zeros	In resource scheduling, there is a distinction made between resource availabilities specified as zero but which can be exceeded under certain circumstances, and hard zeros, which can never be exceeded.
Hierarchical Coding Structure	A coding system that can be represented as a multi-level tree structure in which every code except those at the top of the tree has a parent code.
Hierarchical Project	A project that allows you to break down project information into multiple levels using the activity ID. With hierarchical projects, you enter project data at the lowest level of the project hierarchy, then summarize it to appropriate levels for reporting purposes.
Hierarchical Resource Structure	Resource definitions organized in a hierarchical structure in which every resource except those at the top of the tree has a parent.

Histogram View	A view in which resource or risk information are shown against a time scale. In Open Plan, a resource histogram can be displayed both alone and in combination with a barchart view.
Holiday	An exception to the standard working day. For example, assume that a calendar defines Monday through Friday as days on which work is normally performed. In this case, a specific Monday (such as September 1, 1997) might be identified as a holiday if the office would be closed on that day.
Immediate Activity	An activity that can be forced to start on its earliest feasible date by resource scheduling, even if that means overloading a resource.
In Progress	An activity partially completed.
Internal Subproject	A group of activities represented as a single activity in a higher level of the same project.
Iteration	In Open Plan, one complete trial of Monte Carlo simulation of a project (that is, sampling a value for each activity duration, performing a time analysis with this sampled data, and storing the results). The Monte Carlo technique accumulates the results from a large number of these iterations.
Key Activity	In Open Plan, an activity specified by a user about which the program is to store detailed information generated by risk analysis.
Kurtosis	A technical term used to define a characteristic of the shape of a probability distribution, identified with the thickness of the tails of the distribution.
Labor Resources	Open Plan permits certain resources to be flagged as representing labor. The significance of this is that only resources so flagged will be included in the labor percent complete

	calculations.
Ladder	A style for displaying children in a breakdown structure.
Lag	A time delay associated with a relationship in a project. Lag can be either positive or negative. Negative lag is sometimes called “lead.”
Late Dates	Calculated in the backward pass of time analysis, late dates are the latest dates on which an activity can start and finish.
Late Finish	The latest date on which an activity must be completed if the project completion date and any finish targets are to be met. This date is calculated by time analysis.
Late Start	The latest date on which an activity must start if the project completion date and finish targets are to be met. This date is calculated by time analysis.
Loop	In networks, a consecutive set of activities that are mutually dependent.
Mean	The most common and useful measure of central tendency for a probability distribution. The mean value is the same as the “average” or “expected” value.
Median	A measure of the central tendency of a probability distribution such that there is a 50% chance of a value sampled from the distribution is less than the median.
Milestone	An activity with zero duration — must be designated as either a start milestone or a finish milestone.
Military Time	A means of representing time by use of a 24-hour clock.
Mode	A measure of central tendency for a probability distribution, being the most likely single value for a variable sampled from that distribution. For a theoretical distribution, the mode is represented by the peak of the curve. The mode is the same as the “most

	likely” value.
Monte Carlo Simulation	The technique used in Open Plan to estimate the likely range of outcomes from a complex random process by simulating the process a large number of times.
Most Likely Value	See Mode.
Multiple Ends Processing Option	The multiple ends processing option causes time analysis to treat each end activity as if it was the end of an independent project, so that the float would normally be zero.
Negative Float	The amount of time by which the early date of an activity exceeds its late date.
Network View	A project drawing in which the project logic is the sole determinant of the placements of the activities in the drawing. Frequently called a flowchart, PERT chart, logic drawing, or logic diagram.
Non-Working Day	The standard non-working day on the calendar. For example, assume that a calendar defines Monday through Friday as days on which work is normally performed. In this case, a Saturday that has not been identified as an extra work day would be a non-working day.
Normal Distribution	A family of symmetrical continuous probability distributions defined by two parameters representing the mean and standard deviation of the distribution. In Open Plan, the sampling method for normal distributions is an approximation that curtails the curve at three standard deviations either side of the mean. (In theory there would be approximately a 1% chance of values falling outside of this range.)
Open Plan Auxiliary File	A resource, code, or calendar file associated with an Open Plan project.
Organizational Breakdown Structure (OBS)	A hierarchical structure designed to pinpoint the area of an organization responsible for each cost element in a project.

Out-of-Sequence Progress	Progress that has been reported even though activities that have been deemed predecessors in project logic have not been completed.
Pad Character	A character that is used to fill out a code in a fixed-format significant breakdown structure so that all codes are the same length.
Parent	A higher-level element in a hierarchical structure that summarizes lower-level elements.
Percent Complete	One measure of completion used in Open Plan to determine the remaining duration of a partially completed activity.
Performance Measurement Baseline (PMB)	A baseline that is used for cost calculations. If a PMB exists, it is used even if it is not one of the selected baselines. By always using the PMB when it is available, Open Plan provides consistency and reliability.
Perishable Resource	A consumable resource with an expiration date.
Physical Percent Complete	The percentage of the work content of an activity that has been achieved. See also Budgeted Cost of Work Performed.
Placements	The automatic calculation of coordinates for activities in a network view.
Planned Activity	An activity not yet started.
Precedence Diagram Method (PDM)	One of the two popular methods of representing projects as networks, in which the activities are represented by nodes and the relationships between them by arcs.
Predecessor	An activity that logically precedes another activity. Normally, this term refers to an immediate predecessor, that is, one directly implied by the project data.

Priority Rule	A rule used to determine the order of processing in resource scheduling algorithms.
Probability	The measure of the chance of a particular outcome resulting from a random process. If the process can be performed a number of times, then the proportion of times that a particular outcome results should converge on a value, called the probability, as the number of trials increases.
Probability Distribution	The representation of the range and relative probabilities of the possible outcomes from a random process. A probability distribution may be in the form of a table, a curve, or a histogram.
Progress	The partial completion of a project, or a measure of same. Also, the act of entering progress information for a project.
Project	A set of activities directed to an overall goal. Also, the collection of data relating to the achievement of that goal. More specifically, a network of activities, or the file(s) containing such a network.
Project Logic	The relationships between the various activities in a project.
Punctuated Significant Coding Structure	A coding structure in which a specific character (usually a period) is used to separate the part of the code that corresponds to the different levels in the breakdown structure.
Reprofiling	In resource scheduling, it is possible to indicate that the specified resource requirement profile may be modified to fit the availability, without changing the total amount required.
Relationship	A logical connection between two activities.
Relationship Float	Open Plan permits the calculation of both free and total float on relationships, which are analogous to the float fields on the activities.

Remaining Duration	The remaining portion of an in-progress activity's duration.
Requested Resource	The preferred resource requirement for an activity.
Resource	An item required by an activity. Resources can be people, equipment, facilities, funding — anything needed to perform the work of a project.
Resource Allocation	A feature, used in conjunction with alternate resources, pools, and skills, that allows you to selectively replace a requested resource with one suggested by Open Plan. During resource allocation, you can also selectively lock the allocation of either the requested, or the suggested resource.
Resource Assignment	The requirement for a particular resource by a particular activity, or part of an activity. Sometimes called a resource requirement.
Resource Availability	The level of availability of a resource, which may vary over time.
Resource Breakdown Structure (RBS)	A feature of hierarchical resources.
Resource Level	A specified level of resource units required by an activity per time unit.
Resource Leveling	The resource scheduling process of determining scheduled dates such that neither the project completion date nor any target finishes are jeopardized while minimizing the maximum extent to which any resource availability is exceeded.
Resource-Limited Resource Scheduling	The production of scheduled dates in which the resource constraints are considered as absolute and project completions are delayed as necessary to avoid exceeding resource requirements.
Resource Offset	The number of work periods between the start of the activity and when the resource is first required.
Resource Period	The number of work periods for which a resource is required.

Resource Pool	A higher-level resource in a resource breakdown structure.
Resource Scheduling	The process of calculating a set of scheduled dates that takes into account the resource requirements of each activity and the availability of these resources.
Resource Thresholds	In resource-limited scheduling, it is possible to specify that a particular resource may be exceeded, if necessary, by an amount not to exceed the specified threshold for that resource.
Resource Total	A specified total of resource units required by an activity over a period of time.
Risk Analysis	Any technique designed to quantify the impact of uncertainty. Usually, but not necessarily, associated with the Monte Carlo simulation technique used in Open Plan.
Schedule Dates	The start and finish dates calculated by the resource scheduling program, having regard to resource constraints as well as project logic.
Schedule Variance (SV)	A summary measure of lateness for a project or part of a project.
Scheduled Duration	The scheduled duration of an activity is calculated by resource scheduling, and takes into account such advanced activity management techniques as activity splitting, stretching, or reprofiling.
Scheduled Finish	The date calculated by the resource scheduling program as the earliest date on which an activity can finish, having regard to resource constraints as well as project logic.
Scheduled Float	Calculated during resource scheduling, the scheduled float of an activity is the difference between the late finish date and the scheduled finish date of the activity. In some circumstances, scheduled float may be shared with other activities in the

	logical flow of the project.
Scheduled Start	The date calculated by the resource scheduling program as the earliest date on which an activity can start, having regard to resource constraints as well as project logic.
Skew	A measure of the degree of asymmetry in a probability distribution. For symmetrical distributions, the skew is zero.
Smoothing	A resource-scheduling option that modifies the way time-limited scheduling (and resource-limited scheduling with thresholds) works.
Splitting	In resource scheduling, it is possible to indicate that the specified duration may be divided into two or more pieces, while retaining the specified profile for resource requirements relative to this split duration.
Spreadsheet View	A view in which data is shown in a tabular format. There are single-table spreadsheets and multi-table spreadsheets. An activity spreadsheet is always shown as one of the windows in a barchart view.
Standard Calendar	The default calendar in a calendar file.
Standard Deviation	A measure of the amount of random variation in a random variable, calculated as the square root of the variance. Same as root mean square deviation.
Standard Work Week	The working hours and days defining the basic work pattern for a calendar.
Start Activity	An activity that is not logically dependent on any predecessor activity.
Start Milestone	A milestone activity signifying the start of a project phase.

Start-to-Finish Relationship	<p>The relationship between activities that specifies that the finish of the successor activity depends on the start of the predecessor activity.</p> <p>In most cases, this means that the successor activity cannot be completed before the start of the predecessor activity.</p>
Start-to-Start Relationship	<p>The relationship between activities that specifies that the start of the successor activity depends on the start of the predecessor activity.</p> <p>In most cases, this means that the successor activity cannot be started before the start of the predecessor activity.</p>
Stochastic	Random variation that cannot be predicted other than in statistical terms.
Stretching	In resource scheduling, it is possible to indicate that the specified duration may be increased, while the specified profile is reduced proportionately.
Subsection	A block of data in a spreadsheet that typically begins with a subheading, and ends with a subtotal.
Successor	An activity that logically follows another activity. Normally, this term refers to an immediate successor, that is, one directly implied by the project data.
Symmetrical Distribution	A probability distribution in which variations from the central tendency by a given amount in either direction is equally likely.
Target Date	A date imposed on an activity or project by the user. There are two types of target dates: target start dates and target finish dates.
Target Finish	A finish date imposed on an activity or project by the user.
Target Start	A start date imposed on an activity or project by the user.
Target Type	Open Plan allows you to specify four types of target dates for activity start

	<p>and finish dates:</p> <ul style="list-style-type: none"> ▪ Not Earlier Than — The earliest date on which the activity can start or finish. This constraint affects the early dates calculated by time analysis. ▪ Not Later Than — The latest date on which the activity can start or finish. This constraint affects the late dates calculated by time analysis. ▪ On Target — Combines the effects of both Not Earlier Than and Not Later Than target dates, and affects both the early and late dates calculated by time analysis. ▪ Fixed Target — Requires that the activity take place on the given date even if the logic of the project says that it cannot happen.
Threshold	The level to which Open Plan may exceed the availability of a resource during resource-limited resource scheduling.
Time Analysis	The process of calculating the early and late dates for each activity on a project, based on the Time Now date, the duration of the activities, and the logical relationships between them.
Time Now	The status date of a project. All progress information entered for a project should be correct as of this status date. No work will be scheduled by the time analysis or resource scheduling functions prior to this date.
Total Float	The maximum number of work periods by which an activity can be delayed without delaying project completion or violating a target finish date.
Triangular Distribution	A family of probability distributions that is triangular in shape when represented as a frequency distribution.
Uncertainty	The lack of precision in estimating or

	predicting the outcome of some process.
Uniform Distribution	A family of probability distributions characterized by two parameters, representing the minimum and maximum possible values. Any allowable outcome between the two extreme values is equally likely. For example, the distribution of the outcome from the throwing of a single die is uniform in the range 1 to 6.
Variance	A discrepancy between the actual and planned performance on a project, either in terms of schedule or cost.
Whole Relationship	A relationship in which both the predecessor and the successor activities are visible in the displayed view.
Work Breakdown Structure (WBS)	The breakdown of a project from the client's point of view in terms of deliverables.
Working Day	The standard working day on the calendar. For example, assume that a calendar defines Monday through Friday as days on which work is normally performed. In this case, a Monday that has not been identified as a holiday would be a working day.
Zoning	A feature of Open Plan that causes activities on a network view to be grouped into horizontal bands based on one or more criteria that you specify.

Appendix B - Keyboard Shortcuts

Command	Keyboard Shortcut
New	Ctrl+N
Open	Ctrl+O
Save	Ctrl+S
Print	Ctrl+P
Cut	Ctrl+X
Copy	Ctrl+C
Paste	Ctrl+V
Find	Ctrl+F
Find Next	Shift+F4
Display Next Window	Ctrl+Tab
Help	F1
Add Activity (Activity views)	Ctrl+A
Add Resource (Resource file)	Ctrl+A
Delete Item	Delete
Display Activity Information (Activity views)	F5
Time Analysis (Activity views)	Ctrl+T
Resource Scheduling (Activity views)	Ctrl+R
Risk Analysis (Activity views)	Ctrl+K
Display Time Analysis dialog box (Activity views)	Shift+F9
Placements (Network view)	Shift+P
Properties (Explorer)	Alt+Enter
Define Work Hours (Calendar file)	Ctrl+Spacebar
Previous Year (Calendar file)	Page Up
Next Year (Calendar file)	Page Down
Go to first record in the file (Modeless dialog box)	Ctrl+Home
Go to last record in the file (Modeless dialog box)	Ctrl+End
Go to previous record in the file (Modeless dialog box)	Page Up
Go to next record in the file (Modeless dialog box)	Page Down

Index

A

- About Open Plan button, 19, 28
- About Open Plan command (Help menu), 19
- About Open Plan message box, 19
- Access modes
 - changing modes, 603
 - default, 84, 95, 633
 - exclusive, 61, 85, 95, 632
 - read only, 61, 85, 95, 633
 - shared, 61, 85, 95, 632
- Accomplished Duration field, 372
- Activities
 - actual finish dates, 370, 661
 - actual start dates, 370, 661
 - adding in barchart views, 146
 - adding in network views, 153
 - adding in spreadsheet views, 151
 - as-late-as-possible, 139, 661
 - as-soon-as-possible, 139, 662
 - automatic progressing, 379
 - baseline information, 367
 - calculated dates, 160
 - calculating actual costs, 256, 258
 - calculating budget costs, 253
 - calendars, 139, 230
 - changing durations in barchart views, 148
 - changing target start dates in barchart views, 148
 - characteristics, 136
 - child, 136, 289, 295, 297
 - complete, 309
 - computed remaining duration, 309
 - computed status, 309
 - controlling critical, 160
 - copying between subprojects, 296
 - copying in spreadsheet views, 44
 - costs, 160
 - critical, 160, 309, 664
 - Criticality index, 664
 - cutting in network views, 44
 - cutting in spreadsheet views, 44
 - default duration unit, 120
 - default type, 118
 - defined, 661
 - descriptions, 138
 - discontinuous, 139, 665
 - displaying actual costs, 160
 - displaying budget costs, 160, 259
 - durations, 138
 - early finish dates, 665
 - effort-driven, 140, 177, 225
 - end, 666
 - entering code assignments, 284, 285
 - external subproject, 140
 - finding, 158
 - finish, 309, 666
 - finish milestone, 139
 - float, 160
 - foreign, 303, 667
 - free float, 309, 667
 - guidelines for planning, 136
 - hammock, 139, 304
 - ID, 138, 661
 - identifiers, 136, 138
 - immediate, 325, 668
 - indenting, 298
 - information, 159
 - in-progress, 309, 668
 - internal subproject, 139
 - isolated, 309
 - key, 348, 668
 - maximum duration, 325
 - maximum number of splits, 325
 - minimum duration, 325
 - most critical, 160, 309
 - moving to subprojects, 296
 - not critical, 160, 309
 - notes, 418
 - outdenting, 299
 - pasting in network views, 44
 - pasting in spreadsheet views, 45
 - physical % complete, 376
 - planned, 309, 671
 - predecessors, 671
 - relationships, 143
 - remaining duration, 673
 - reprofiling, 672
 - reprofiling, 324
 - resource scheduling attributes, 323
 - selecting in network views, 41
 - selecting in spreadsheet views, 41
 - splitting, 323, 675
 - start, 309, 675
 - start milestone, 139, 675
 - start/finish, 309
 - status, 661
 - stretching, 323, 676
 - subproject, 136, 289
 - successors, 676
 - target dates, 140, 676
 - time analysis calculations, 309
 - total float, 308, 677
 - types, 139
 - utilities, 158
- Activity calendars, 119, 233
- Activity Details dialog box
 - Advanced tab, 325, 335
 - Codes tab, 284
 - described, 137
 - General tab, 138
 - Relationships tab, 143
 - Resources tab, 206
 - Risk tab, 346
 - User Fields tab, 142
- Activity Information command (Edit menu), 161, 164
- Activity Information dialog box, 159

Index

- Activity Progress dialog box
 - Activity tab, 369
 - Resources tab, 375
 - Activity Resource Allocation dialog box, 220
 - Activity spreadsheet views
 - adding activities, 151
 - described, 155
 - entering code assignments, 286
 - Activity/resource spreadsheet views, 216
 - Actual cost of work performed, 125, 161, 248, 261, 503, 661
 - Actual costs
 - based on resource progress, 179
 - calculating, 256, 258
 - role in earned value calculations, 248
 - Actual date option, 313
 - Actual start and finish dates, 369, 373
 - ACWP. *See* Actual cost of work performed
 - Add Activity command (Edit menu), 137, 146, 151, 153, 453
 - Add Annotation command (Edit menu), 445, 446
 - Add Baseline dialog box, 360
 - Add Child command, 188, 275, 295
 - Add Code command (Edit menu), 275
 - Add Relationship command (Edit menu), 145, 149, 154, 157
 - Add Relationship cursor, 149, 154, 465
 - Add Resource command (Edit menu), 188
 - Add Skill dialog box, 193
 - Adding
 - activities in barchart views, 146
 - activities in network views, 153
 - activities in spreadsheet views, 151
 - calculated fields, 563
 - child activities in network views, 295
 - child activities in spreadsheet views, 297
 - child codes, 275
 - code assignments, 286
 - codes, 275
 - codes to code file, 275
 - filter expressions, 548
 - global edits, 572
 - network annotations, 446
 - project-level codes, 646
 - relationships, 144, 145
 - relationships in barchart views, 147
 - relationships in network views, 154
 - relationships in spreadsheet views, 157
 - resource assignments, 216
 - resources, 188
 - sort expressions, 556
 - spreadsheet columns, 472
 - standard views, 645
 - symbols, 399
 - Advisory Definitions dialog box, 587
 - ALAP. *See* As-late-as-possible activities
 - All Resource Categories, 214
 - Allocation. *See* Resources, allocation
 - Allocation command (Edit menu), 221
 - Alternate resources, 208, 220, 661
 - Annotations, 445
 - Application shortcuts, 69
 - ASAP. *See* As-soon-as-possible activities
 - As-late-as-possible activities, 139, 661
 - Assign Code dialog box, 90, 283
 - Assign Multiple Resources to Multiple Activities dialog box, 211
 - Assignment profile curves, 226, 662
 - As-soon-as-possible activities, 139, 662
 - Asymmetrical distributions, 662
 - Automatic activity progressing
 - discussion, 379
 - session log, 382
 - Automatic numbering
 - defined, 140
 - examples, 141
 - in activity views, 140
 - in resource views, 190
 - in spreadsheet views, 492
 - indenting, 298
 - outdenting, 299
 - rules, 140
 - Automatic placements
 - defined, 453, 671
 - saving, 456
 - Automatic resource progressing
 - description, 383, 386
 - session log, 384
 - Automatic Scaling dialog box, 431
 - Automatic time analysis, 315
 - Autoscaling, 430
 - Availabilities. *See* Resources, availabilities
 - Availability dates, 180
 - Availability options
 - Total & Reserved, 500
 - Total & Reserved or Used, 500
 - Total Availability, 500
 - Total, Reserved and Used, 500
 - Unreserved and Used, 500
 - Unreserved Availability, 500
 - Unused Availability, 500
 - Average, 662
- ## B
- BAC. *See* Budget at completion
 - Backup, 594
 - Backup dialog box, 594
 - Backup File command (File→Manage Files submenu), 595
 - Backward pass, 308, 662
 - Bar Data Mode button, 28, 147, 372
 - Bar Data Mode command (View menu), 372
 - Bar Set field, 114
 - Bar Set Preferences dialog box, 437
 - Bar Sets command (Tools menu), 437
 - Barchart Preferences dialog box, 435
 - Barchart views
 - adding activities, 146
 - adding relationships, 147
 - changing activity durations, 148
 - changing target start dates, 148
 - clicking to sort, 560
 - custom date scales, 426

- date range, 407
- defined, 146, 391, 425, 662
- display of Time Now marker, 436
- display options, 435
- displaying controlling relationships, 435
- displaying relationships, 146, 435
- displaying temporary filters, 550
- histogram pane in reports, 407
- legend, 408
- multi-table, 437
- printing, 404
- relationship mode, 147
- spreadsheet pane in reports, 407
- title blocks, 410
- Baseline Security dialog box, 365
- Baselines
 - copying, 363
 - creating, 360
 - defined, 360, 662
 - defining access rights, 364
 - deleting, 367
 - deleting all activities no longer in current project, 363
 - displaying baseline information, 367
 - fields, 367
 - filters, 362
 - including complete activities, 362
 - including in-progress activities, 362
 - managing, 366
 - performance measurement baseline, 124, 366
 - rolling up data, 363
 - security, 365
 - selecting, 117
 - updating, 364
 - user defined fields, 577
- Baselines command (Project menu), 360, 363, 365, 366
- Baselines dialog box, 360
- BCWP. *See* Budgeted cost of work performed
- BCWS. *See* Budgeted cost of work scheduled
- Beta distribution shape, 347, 662
- bk3 files, 594
- Breakdown structures, 265, 663
- Briefcase system folder, 52
- Briefcasing
 - auxiliary files, 601
 - checking in a file, 602
 - checking out in main data source, 601
 - checking out to briefcase data source, 601
 - described, 52, 600
 - undoing check out, 603
 - views, 601
- Budget at completion, 124, 161, 261, 663
- Budgeted cost of work performed, 125, 161, 248, 261, 503, 663
- Budgeted cost of work scheduled, 124, 161, 248, 503, 663
- Budgets
 - baseline dates, 248
 - calculating for activities, 253
 - defined, 663
 - displaying activity costs, 160, 259
 - displaying project costs, 260
- Buttons
 - described, 27
 - dimmed, 29
 - displaying a description, 29
 - navigation, 36
 - outlining, 297
 - selection, 41
- C**
- Calculated Field Expression dialog box, 562
- Calculated fields
 - access control, 562
 - adding, 563
 - calculating across summary rows, 562
 - copying, 563
 - defining, 561
 - deleting, 564
 - described, 561
 - editing, 563
 - references, 563
 - results, 561
 - temporary calculated fields, 564
 - use in cost reporting, 261
- Calculated Fields command (Tools menu), 563
- Calendar files
 - assigning to projects, 67, 121, 230, 231
 - assigning to resource files, 233
 - assigning to resources, 231
 - copying, 231
 - creating, 230
 - default calendar, 232
 - defined, 230, 663
 - deleting, 231
 - icons, 230
 - opening, 231
 - standard calendar, 675
- Calendar Preferences dialog box
 - Color tab, 242
 - described, 242
 - Layout tab, 242
- Calendars
 - adding, 235
 - adding a child, 241
 - assigning to activities, 139
 - assigning to relationship lags, 144
 - controlling the display, 242
 - copying, 241
 - default, 232
 - default activity calendar, 119, 233
 - default relationship calendar, 119, 233
 - defined, 230, 232, 663
 - defining standard work week, 236
 - deleting, 242
 - entering information, 237
 - extra days, 232, 666
 - fonts, 243
 - holidays, 232, 668
 - keyboard shortcuts, 237
 - non-working days, 232, 670
 - printing, 403

Index

- renaming, 241
- reporting calendars, 124
- resource calendars, 180
- standard work week, 675
- Start Day of Week setting, 242
- Start Month of Year setting, 242
- working days, 232, 678
- Cascade command (Window menu), 34
- Central tendency, 663
- Change Access Mode dialog box, 603
- Change Mode command (File→Manage Files submenu), 604
- Change Password command (File menu), 617
- Changing
 - access modes, 602
 - activities to internal subprojects, 291, 292
 - activity durations in barchart views, 148
 - activity target start dates in barchart views, 148
 - data sources, 614
 - default calendar, 232
 - work status of a day, 238
- Check boxes, 35
- Check In command (File→Manage Files submenu), 603
- Check In dialog box, 602
- Check Out command (File→Manage Files submenu), 602
- Check Out dialog box, 600
- Check Spelling dialog box, 624
- Child activities, 136
- Choose a Project dialog box, 392
- Click to Sort option, 560
- Clip Notes, 17, 21, 640
- Clipboard function, 43
- Close command
 - using the Close button, 65
 - using the context menu, 65
 - using the Control menu, 66
 - using the File menu, 65
- Code Details dialog box
 - Code tab, 272
 - described, 272
 - Notes tab, 274
 - User Fields tab, 273
- Code Display Preferences dialog box
 - Box Layout tab, 279
 - Options tab, 278
- Code File Prompt dialog box, 90
- Code files
 - assigning to projects, 121, 271
 - assigning to resource files, 271
 - copying, 270
 - creating, 268
 - defined, 269, 663
 - deleting, 271
 - icons, 269
 - notes, 418
 - opening, 269
 - removing from projects, 270
 - removing from resource files, 270
- Code views, 391
- Codes
 - adding, 275
 - adding a child, 275
 - adding project-level codes, 646
 - adding to code file, 275
 - assigning codes in spreadsheet views, 286
 - assigning codes to projects, 67, 131
 - assigning to resource files, 90
 - assigning to resources, 179
 - assignments, 283
 - breakdown structures, 265, 663
 - child codes, 266
 - collapsing parent codes, 277
 - custom box text, 279
 - deleting, 70, 276
 - described, 265
 - descriptions, 273
 - displaying code information, 278
 - editing, 276
 - entering assignments, 284, 285
 - expanding all parent codes, 277
 - finding, 276
 - fixed format significant, 96, 267
 - fixed level length, 267
 - hierarchies, 265, 667
 - identifiers, 273
 - moving in hierarchy, 276
 - notes, 418
 - pad characters, 267, 671
 - parent codes, 266
 - punctuated significant, 96, 265, 267, 672
 - selecting, 42
 - self-defining structures, 265
 - summarizing, 266
- Collapse All button, 28, 295, 298, 450
- Collapse All command (View menu), 295, 298, 450
- Collapse button, 28, 190, 277, 298
- Collapse command (View menu), 190, 277, 298
- Color dialog box, 475, 499
- Command buttons, 35
- Commands
 - context menus, 31
 - dimmed, 27
 - keyboard shortcuts, 33
 - selecting, 26
 - submenus, 27
 - toolbar, 27
 - using the menu bar, 26
- Complete activities, 309
- Computed remaining duration, 309
- Computed status, 309
- Confidence, 663
- Confidence interval, 664
- Constraints. *See* Target dates
- Consumable resources, 176, 181, 664
- Contents command (Help menu), 18
- Context menus, 31
- Context-sensitive help. *See* Help system
- Control menu, 33
- Controlling critical activities, 160
- Controlling relationships, 435, 664
- Copy Baseline dialog box, 363
- Copy button, 28, 43, 45, 296

- Copy command (Edit menu), 43, 296
- Copy User Defined Field dialog box, 578
- Copying
 - activities between subprojects, 296
 - activities in spreadsheet views, 44
 - baselines, 363
 - calculated fields, 563
 - calendar files, 231
 - calendars, 241
 - code files, 270
 - effect of filters, 544
 - filter expressions, 549
 - global edits, 573
 - reporting calendars, 417
 - resource files, 172
 - sort expressions, 557
 - text, 43
 - title blocks, 411
 - user defined fields, 578
- Cost Calculations
 - Use Version 2 Cost Calculation Method, 124
- Cost Calculations button, 29
- Cost Calculations command (Tools menu), 258
- Cost performance index, 261
- Cost variances, 261, 664
- Costs
 - activity-level, 375
 - actual cost of work performed, 161, 248, 261, 503
 - budget, 663
 - budget at completion, 161, 261
 - budgeted cost of work performed, 161, 248, 261, 503
 - budgeted cost of work scheduled, 161, 248, 503
 - calculating actual costs, 256, 258
 - calculating budget costs, 253
 - cost performance index, 261
 - cost variances, 249, 261
 - displaying budget costs, 259
 - displaying earned value, 503
 - earned value cost control, 248, 665
 - escalations, 182
 - estimate at complete, 161, 261, 503
 - estimate to complete, 261
 - forecasting, 503
 - physical percent complete, 671
 - planned baseline progress, 261
 - planning, 251
 - progress information, 375
 - reporting, 261
 - resource cost based on progress, 179
 - schedule performance index, 261
 - schedule variances, 249, 261
 - target total, 124
 - variance at complete, 261
- CPF. *See* Cost performance factor
- CPI. *See* Cost performance index
- Creating
 - application shortcuts, 69
 - auxiliary files, 62, 80
 - baselines, 360
 - calendar files, 230
 - code files, 268
 - custom folders, 51
 - Email Advisor address list, 591
 - email advisory definitions, 587
 - hammocks, 304
 - new templates, 393
 - projects, 62, 80, 643
 - report batches, 627
 - reporting calendars, 416
 - resource files, 171
 - temporary filters, 550
 - temporary sorts, 557
 - title blocks, 411
 - user defined fields, 578
 - using the New File dialog box, 62, 80
 - using the New File Wizard, 62, 84
- Critical activities, 160, 309, 664
- Critical path, 664
- Criticality index, 349, 354, 664
- Crosstable Export Definition dialog box
 - Access Control tab, 539
 - Resource Data tab, 538
- Crosstable exports, 530
- Crosstable Exports
 - Group field, 539
 - Read Only field, 539
 - Role field, 539
 - User ID field, 539
- Crosstable Exports
 - access control, 539
 - owner field, 539
 - resource data, 538
- Crosstable exports dialog box, 530
- Cumulative distributions, 664
- Cursors
 - Add Relationship, 149, 154, 465
 - Duration, 148
 - Move, 154, 444, 446
 - Paste, 44, 296
 - Progress, 372
 - Resize, 153, 442, 444
 - shapes, 39
 - Split view, 464, 474
 - Target Start, 148
 - Update Relationship, 154
 - Zoom, 414
- Curves. *See* Assignment profile curves
- Custom folders, 51
- Customizing the Details format display, 55
 - best fit, 59
 - customizing columns, 56
 - filtering, 71
 - removing columns, 57
 - renaming columns, 58
 - sort ascending, 58
 - sort descending, 58
- Cut button, 28, 43, 44, 296
- Cut command (Edit menu), 43, 295, 296
- Cutoff files. *See* Reporting Calendars
- Cutting
 - activities in network views, 44
 - activities in spreadsheet views, 44
 - effect of filters, 544

Index

text, 43
CV. *See* Cost variance

D

Data sources

changing, 614

Data Sources command (Tools menu), 614

Data Sources dialog box, 614

Data type, 577

Date Range Options dialog box, 408

Date Scale Preferences dialog box

Manual tab, 427, 430

Options tab, 426

Reporting Calendar tab, 432

Date scales

adjusting, 433

autoscaling, 430

axis height, 429

customizing, 426

defining, 430, 431, 433

font, 429

format, 427

full scale, 429

histogram views, 510

in histogram views, 514

line width, 429

manual definition, 427, 430

non-linear, 415

parameters, 427

position, 429

relative dates, 429

reporting calendars, 415, 432

Dates

actual finish, 369, 661

actual start, 369, 661

calculation by time analysis, 308

default format, 118

display of relative dates, 429

earliest feasible, 321, 665

early, 308, 665

early finish, 122, 308, 310, 665

early start, 308, 665

finding in calendar, 238

late, 308, 669

late finish, 122, 308, 669

late start, 308, 669

project start, 122

scheduled, 321, 674

scheduled finish, 122, 321, 674

scheduled start, 321, 675

target, 122, 140, 676

target finish, 122, 140, 676

target start, 676

target types, 122, 140, 676

Default access mode, 84, 95, 110, 116, 120, 130, 633

Default calendars, 232

Default duration unit, 120, 208

Default projects, 643

Define Work Hours command (Edit menu), 238

Define Work Hours dialog box, 238

Define Work Week command (Edit menu), 236

Define Work Week dialog box, 236

Defining

access rights to calendar files, 617

access rights to code files, 617

access rights to projects, 617

access rights to resource files, 617

access rights to view templates, 617

bars in histogram views, 508, 513

calculated fields, 561

cost resources, 252

custom zoning in network views, 456

date scales, 430, 431, 433

filters, 546

global edits, 570

links in spreadsheet views, 488

outlining in spreadsheet views, 485

skills, 193

sorts, 555

subsections in spreadsheet views, 481

temporary calculated fields, 564

temporary filters, 550

temporary sorts, 558

time scaling in network views, 458

Delaying resource, 665

Delete Code command (Edit menu), 276

Delete File command (File→Manage Files submenu),
593

Delete Relationship command, 154

Delete Resource command (Edit menu), 172, 189

Deleting

calculated fields, 564

calendar files, 231

calendars, 242

code files, 271

codes, 70, 276

email advisory definitions, 587

files, 70, 593

filter expressions, 549

from My Folder, 51, 70

from Open Plan Library, 52, 70

from Projects, 52, 70

from Startup, 54

global edits, 573

notes, 419

relationships in network views, 154

report batches, 629

reporting calendars, 417

resource files, 172

skills, 194

sort expressions, 557

spreadsheet columns, 473

symbols, 399

user defined fields, 579

views, 394

Dialog boxes

check boxes, 35

command buttons, 35

default commands, 35

described, 35

getting help, 17

list boxes, 35

modeless, 36

- navigation, 35
 - navigation buttons, 36
 - radio buttons, 35
 - tabbed, 36
 - text boxes, 35
 - Dictionaries dialog box, 625
 - Discontinuous activities, 139, 665
 - Distribution shapes
 - asymmetrical, 662
 - beta, 347
 - normal, 347, 670
 - symmetrical, 676
 - triangular, 347, 677
 - uniform, 347, 678
 - Drag and drop, 51, 52, 66, 68, 231
 - Duration cursor, 148
 - Durations
 - activity, 138
 - changing in barchart views, 148
 - computed, 321
 - conversions, 119
 - default unit, 120, 208
 - defined, 665
 - discontinuous activities, 139
 - hammocks, 304
 - maximum, 325
 - minimum calculated, 120, 325
 - mode, 347
 - optimistic, 346
 - original, 321
 - pessimistic, 346
 - probability distribution, 346
 - remaining, 673
 - scheduled, 321, 674
- ## E
- EAC. *See* Estimate at complete
 - Earliest feasible dates, 321, 665
 - Early dates, 308, 665
 - Early finish dates
 - activities, 308, 665
 - projects, 122, 310
 - Early start dates, 308, 665
 - Earned value cost control, 248, 665
 - Edit Activity command (Edit menu), 152, 154
 - Edit Advisor Emails dialog box, 587
 - Edit box, 38
 - Edit Code command (Edit menu), 276
 - Edit Date Scale command (View menu), 430
 - Edit Reporting Calendar dialog box, 415
 - Edit Resource command (Edit menu), 189
 - Edit User Defined Field dialog box, 579
 - Editing
 - calculated fields, 563
 - codes, 276
 - email advisory definitions, 587
 - filter expressions, 548
 - global edits, 573
 - network annotations, 447
 - relationships in network views, 154
 - report batches, 629
 - reporting calendars, 416
 - sort expressions, 556
 - time-scaled headers, 459
 - title blocks, 411
 - user defined fields, 579
 - zone headers, 457
 - Effort factor, 177
 - Effort-driven activities, 177, 225
 - Elapsed duration, 370
 - Email Advisor command (Tools menu), 587
 - Email Advisor utility
 - address format, 589
 - creating address lists, 591
 - creating advisory definitions, 587
 - deleting advisory definitions, 587
 - described, 587
 - editing advisory definitions, 587
 - filtering, 590
 - temporary filtering, 590
 - testing advisory definitions, 590
 - Emailing project information, 621
 - End activities, 666
 - Error logs. *See* Session logs
 - Escalations, 182, 666
 - Estimate at complete, 125, 161, 261
 - Estimate to complete, 261
 - ETC. *See* Estimate to complete
 - Exclusive access mode, 61, 85, 95, 632
 - Exit command (File menu), 20
 - Exiting Open Plan, 20
 - Expand All button, 28, 190, 277, 294, 298, 449
 - Expand All command (View menu), 190, 277, 294, 298
 - Expand button, 28, 190, 294, 298, 449
 - Expand command (View menu), 190, 294, 449, 450
 - Expanded subprojects, 293
 - Expected finish dates, 370
 - Expected value, 662
 - Export dialog box, 529
 - Export General command (File→Export submenu), 529
 - Export MSP98/2000 command (File→Export submenu), 524
 - Export MSP98/2000 command (File/Export submenu), 525
 - Export XER utility, 526
 - Exporting
 - general, 517, 529
 - Microsoft Project 98/2000, 517
 - Primavera Project Planner, 526
 - External Subproject Open dialog box, 301
 - External subprojects. *See* Subprojects
 - Extra work days, 232, 666
- ## F
- Fields dialog box, 412
 - File Open dialog box
 - described, 60, 631
 - exclusive mode, 631
 - listing files by type, 631
 - read only mode, 631

Index

- shared mode, 631
 - Files
 - access mode, 631
 - access rights, 616
 - activity, 661
 - assigning, 66
 - backing up, 594
 - bk3 file format, 594
 - briefcasing, 600
 - closing, 65
 - default access mode, 633
 - deleting, 70, 593
 - exclusive access mode, 61, 632
 - finding, 73
 - management, 593
 - multi-user, 631
 - opening, 60
 - owners, 364, 616
 - read only access mode, 61, 633
 - restoring, 595
 - saving, 64
 - security, 616
 - shared access mode, 61, 632
 - Fill Column Down command (Edit menu), 473
 - Filter Expression dialog box, 546
 - Filter Expression dialog box (expanded), 547
 - Filter Settings dialog box, 72
 - Filters
 - access control, 548
 - adding, 548
 - copying, 549
 - defining, 71, 546
 - deleting, 549
 - described, 544
 - editing, 548
 - email advisories, 590
 - expressions, 546, 548
 - field names in, 546
 - Fields button, 548
 - Functions button, 548
 - in baselines, 362
 - logical operators, 546
 - operators, 547
 - references, 548
 - refreshing, 545
 - temporary filters, 550
 - use of parentheses, 547
 - using, 544
 - validating the expression, 548
 - values in, 547
 - Filters command (Tools menu), 72, 544
 - Filters dialog box, 544
 - Find command (Edit menu), 73, 159, 189, 276
 - Find dialog box, 73
 - Find In Log dialog box, 611
 - Find Next command (Edit menu), 159
 - Find Record dialog box, 158
 - Finding
 - activities, 158
 - codes, 276
 - files, 73
 - in logs, 611
 - Finish activities, 309, 666
 - Finish milestone activities, 139, 666
 - Finish-to-finish relationships, 144, 148, 666
 - Finish-to-start relationships, 144, 148, 666
 - Fixed format significant coding systems, 96, 267, 666
 - Fixed seed points, 350
 - Fixed Target target dates, 140
 - Float
 - calculation by time analysis, 308
 - controlling critical activities, 160
 - critical activities, 160
 - defined, 667
 - finish, 666
 - free, 309, 667
 - minimum total, 122
 - most critical activities, 160
 - negative, 308, 670
 - not critical activities, 160
 - relationship, 672
 - remaining, 335
 - scheduled, 674
 - total, 308, 677
 - types, 160
 - Font command (Tools menu), 243
 - Fonts
 - in annotations, 446
 - in calendars, 243
 - in date scales, 429
 - in histogram views, 510
 - in outlining, 487
 - in subsection headings, 482
 - in time-scaled headers, 459
 - in zone headers, 457
 - Forecasting, 503
 - Foreign activities, 303, 667
 - Forward pass, 308, 667
 - Free float, 309, 667
- ## G
- Gantt chart. *See* Barchart views
 - Global Edit command (Tools menu), 572
 - Global Edit Definition dialog box, 570
 - access control, 572
 - applies to table, 570
 - fields, 572
 - functions, 572
 - matching filter, 572
 - name, 570
 - of type, 571
 - references, 572
 - replace values in, 571
 - values, 572
 - with expression, 571
 - Global edits
 - adding, 572
 - applying, 569
 - copying, 573
 - defining, 570
 - deleting, 573
 - described, 569
 - editing, 573

Global Edits dialog box, 569
 Global View option, 60
 Go To Date command (View menu), 161, 238
 Go to Date dialog box, 161
 Go To Parent button, 28, 294
 Go To Parent command (View menu), 294, 295
 Go To Predecessor command, 154
 Go To Subproject button, 28, 294
 Go To Subproject command (View menu), 293, 450
 Go To Successor command, 154
 Go To Top Level command (View menu), 294, 452
 Grand totals, 479
 Grid lines, 475

H

Hammocks
 activity type, 139
 creating, 304
 defined, 304, 667
 durations, 304
 restrictions, 304
 Hard zeros processing option, 181, 333, 667
 Help menu, 17
 Help system
 Clip Notes, 17, 640
 described, 17
 displaying help, 18
 using, 17
 Hierarchical priority field, 335
 Hierarchical projects. *See* Subprojects
 Histogram Preferences command (Tools menu), 502, 504, 510
 Histogram Preferences dialog box
 Earned Value tab, 503
 Options tab, 508
 Resources tab, 499
 Histogram views
 availability, 500
 cumulative curves, 497, 512
 customizing the date scale, 510, 514
 date range, 407
 defined, 391, 495, 668
 defining bars, 508, 513
 displaying earned value, 503
 legends, 496, 511
 printing, 404
 resource, 495
 risk, 355, 495, 511
 selecting key activities, 513
 selecting resources, 506
 tabular format, 496, 511
 title blocks, 410
 Holidays
 defined, 232, 668
 setting up, 239
 HTML. *See* Hyper Text Markup Language
 Hyper Text Markup Language, 626

I

Icons

calendar files, 230
 code files, 269
 resource files, 171
 selecting, 40
 Immediate activities, 325, 668
 Import dialog box, 528
 Import General command (File→Import submenu), 528
 Import MSP98/2000 File command (File→Import submenu), 520
 Import MSP98/2000 File command (File/Import submenu), 521
 Import P3 File utility, 526
 Import XER utility, 526
 Importing
 .mpd files, 518
 .mpp files, 518
 general, 517, 528
 Primavera Project Planner, 517, 526
 Indent button, 28, 299
 Indent command (Edit menu), 299
 Indenting
 activities, 298
 defined, 298
 examples, 298
 spreadsheets, 491
 In-progress activities, 309, 668
 In-progress priority processing option, 332
 Intermediate display mode, 460
 Internal subprojects. *See* Subprojects
 Isolated activities, 309

K

Key activities, 348, 668
 Key Activity Selection dialog box, 513
 Keyboard shortcuts, 33, 150, 237
 Kurtosis, 668

L

Labor resources, 214, 668
 Ladder format, 197, 278, 669
 Lags
 calendars, 144
 default calendar, 144
 defined, 669
 described, 144
 duration-driven, 144
 percentage, 144
 Late dates, 308, 669
 Late finish dates
 activities, 308, 669
 projects, 122
 Late start dates, 308, 669
 Lead time. *See* Lags
 Legends
 customizing, 443
 in histogram views, 496, 511
 in network views, 443
 positioning manually, 444

Index

- viewing, 443
- Leveling. *See* Resource scheduling
- Linking in spreadsheet views, 488
- List boxes, 35
- Lists, 38
- Load Options dialog box, 519
- Locking. *See* Resources, locking
- Log Viewer. *See* Open Plan Log Viewer
- Log Viewer command (View menu), 609
- Logged-in User dialog box, 53
- Logic diagrams. *See* Network views
- Logic drawings. *See* Network views
- Logical loops, 145, 669
- Loop detection, 145, 299

M

- Make Straight command, 154
- Manage Calendars dialog box, 235, 240
- Manage Holidays command (Edit menu), 240
- Manage Note Categories dialog box, 420
- Manage Reporting Calendars dialog box, 415
- Manage Skills command (Tools menu), 193
- Manage Skills dialog box, 192
- Manage Summary File dialog box, 127
- Manage Symbols dialog box, 399, 641
- Managing baselines, 366
- Margins, 405
- Material resources, 214
- Maximize command (Control menu), 34
- Maximum duration, 325
- Maximum number of splits, 325
- Mean value, 662, 669
- Median value, 669
- Menu bar, 26
- Microsoft Project 98/2000 Export
 - defined, 521
 - saving in .mpd format, 522
 - saving in .mpp format, 522
 - system requirements, 518
- Microsoft Project 98/2000 Import
 - defined, 518
 - selecting .mpd files, 518
 - selecting .mpp files, 518
 - system requirements, 518
- Milestones
 - defined, 669
 - finish, 666
 - finish milestone activities, 139, 666
 - start milestone activities, 139, 675
- Military time, 669
- Minimize command (Control menu), 34
- Minimum calculated duration, 120
- Minimum duration, 325
- Minimum total float, 122
- Mode durations, 347
- Mode value, 669
- Modeless dialog boxes, 36
- Most critical activities, 160, 309
- Mouse techniques
 - cursor shapes, 39
 - right-clicking, 31

- Move command (Control menu), 34
- Move cursor, 154, 444, 446
- Multiple Baselines dialog box, 366
- Multiple ends processing option, 313, 670
- Multi-project processing. *See* Subprojects
- Multi-table spreadsheet views, 469
- Multi-user features
 - described, 631
 - file access, 631
 - shared mode, 632
- My Folder system folder, 51

N

- Navigation buttons, 36
- Negative float, 670
- Network preferences
 - draft mode, 462
 - showing page breaks, 462
 - snapping to grid, 462
- Network view
 - defined, 391
- Network View Annotation dialog box, 445
- Network View Preferences dialog box
 - Legend tab, 443
 - Options tab, 462
- Network views
 - adding activities, 153
 - adding child activities, 295
 - adding relationships, 154
 - annotations, 445
 - automatic placements, 453, 671
 - cutting activities, 44
 - defined, 670
 - defining temporary calculated fields, 564
 - defining temporary filters, 551
 - deleting relationships, 154
 - described, 153, 441
 - display options, 462
 - displaying multiple subprojects, 450
 - displaying subprojects, 293, 448
 - displaying temporary filters, 550
 - editing relationships, 154
 - intermediate display mode, 460
 - legends, 443
 - normal display mode, 460
 - pasting activities, 44
 - printing, 404
 - reduced display mode, 460
 - resizing boxes, 442
 - splitting, 464
 - time-scaling, 458
 - title blocks, 410
 - zoning, 456, 678
 - zoom commands, 460
- New button, 28, 171
- New Calculated Field dialog box, 561
- New Code Structure dialog box, 267
- New command (File menu), 268
- New File dialog box, 62, 80
- New File Wizard
 - Code Structure page, 81, 95

- Create page, 81, 84
 - described, 62, 66
 - External Subprojects page, 81, 92
 - Files page, 81, 88
 - Notes page, 81, 97
 - Preferences page, 81, 93
 - Security page, 81, 98
 - Status Information page, 81, 87
 - Summary page, 81, 86
 - using the New File Wizard, 84
 - New Filter dialog box, 546
 - New Sort dialog box, 555
 - New User Defined Field dialog box, 577
 - Next command (Control menu), 33
 - Next Year command (View menu), 239
 - Non-linear date scales, 415
 - Non-working days, 232, 670
 - Non-working times, 230
 - Normal display mode, 460
 - Normal distribution shape, 347
 - Not critical activities, 160, 309
 - Not Earlier Than target dates, 123, 140
 - Not Later Than target dates, 123, 140
 - Note Categories command (Tools menu), 420
 - Notes
 - adding, 125
 - categories, 419
 - deleting, 419
 - description, 418
 - including in reports, 405, 421
 - printing, 405
 - spell checking, 624
- O**
- Offsets, 208
 - OLE Setup, 14
 - On Target target dates, 123, 140
 - Online help. *See* Help system
 - Open button, 28, 172, 269
 - Open command (File menu), 171, 231, 269
 - Open Plan
 - Desktop edition, 12
 - documentation, 21
 - exiting, 20
 - file management, 593
 - help system, 17, 21
 - multi-user features, 631
 - Professional edition, 12
 - security features, 616
 - starting, 15
 - system information, 19
 - system options, 640
 - working with windows, 33
 - Open Plan Developer's Guide*, 14, 21
 - Open Plan Explorer
 - contents pane, 55
 - deleting files, 70
 - described, 50, 60
 - hierarchical pane, 51
 - system folders, 50
 - Open Plan Explorer display formats
 - Details, 55
 - Large Icons, 55
 - Small Icons, 55
 - Open Plan files, 670
 - Open Plan Library system folder, 52
 - Open Plan Log Viewer
 - described, 609
 - Find button, 611
 - resource scheduling, 330
 - risk analysis, 351
 - time analysis, 314
 - Open Plan Migration Utility, 14
 - Open Plan Release Notes*, 14
 - Open Plan User's Guide*, 14, 21
 - Open Plan Web Publisher
 - creating report batches, 627
 - deleting report batches, 629
 - described, 626
 - output options, 630
 - previewing report batches, 629
 - running report batches, 629
 - updating report batches, 629
 - URL links, 630
 - use of .pdf files, 626
 - use of HTML files, 626
 - Open Plan Web Publisher dialog box, 627
 - Open Status tab
 - machine ID, 110, 130
 - open mode, 110, 130
 - opened on, 110, 130
 - user ID, 110, 130
 - Opening
 - calendar files, 231
 - code files, 269
 - external subprojects, 301
 - resource files, 171
 - views, 393
 - Opp_prog.log, 382, 384
 - Opp_risk.log, 349
 - Opp_rs.log, 330
 - Opp_ta.log, 311
 - Options command (Tools menu), 640
 - Options dialog box
 - Advanced tab, 650
 - Codes tab, 646
 - Color tab, 647
 - Edit tab, 642
 - Email options, 649
 - Email tab, 648
 - General tab, 640
 - MAPI, 649
 - Project tab, 643
 - SMTP, 649
 - SMTP Server Information, 649
 - Views tab, 644
 - Organizational breakdown structure, 670
 - Other Direct Costs resources, 214
 - Outdent button, 28, 300
 - Outdent command (Edit menu), 300
 - Outdenting
 - activities, 299
 - defined, 299

Index

- examples, 299
 - spreadsheets, 491
 - Outlining
 - described, 484
 - effect of filters, 544
 - effect of sort order, 484
 - enabling, 485
 - Outlining button, 297
 - Out-of-sequence progressing, 313, 373, 671
 - Owners, 364, 616
- ## P
- P3Export Add-Ins tool, 526
 - Pad characters, 267, 671
 - Passwords, 617
 - Paste button, 28, 44, 45, 296
 - Paste command (Edit menu), 43, 295, 296
 - Paste cursor, 44, 296
 - Pasting
 - activities in network views, 44
 - activities in spreadsheet views, 45
 - effect of filters, 544
 - text, 44
 - PDF. *See* Portable Document Format
 - PDM. *See* Precedence diagramming method
 - Percent complete, 370
 - Performance Measurement Baseline, 124, 671
 - Perishable resources, 176, 181, 671
 - PERT charts. *See* Network views
 - Physical percent complete, 248, 671
 - Placements, 453, 671
 - automatic, 454
 - avoiding page breaks, 454
 - filtering projects, 455
 - Filters button, 455
 - manual, 454
 - saving as manual, 454
 - showing all levels, 454
 - Time Scale button, 455
 - time scaling projects, 455
 - Zoning button, 455
 - zoning projects, 455
 - Placements command (Tools menu), 455
 - Placements dialog box, 453
 - Planned activities, 309, 671
 - Planned baseline progress, 261
 - PMB. *See* Performance measurement baseline
 - Pools. *See* Resources, pools
 - Portable Document Format, 626
 - Precedence diagramming method, 671
 - Predecessor activities, 671
 - Predecessor/successor spreadsheet views, 156
 - Preferences command (Tools menu), 197, 279, 514
 - Previous Year command (View menu), 239
 - Primavera Project Planner, 526
 - Print button, 28, 403
 - Print command (File menu), 402
 - Print dialog box, 402
 - Print Options command (File menu), 404
 - Print Options dialog box
 - General tab, 404
 - View tab, 406
 - Print Preview button, 28, 413, 414
 - Print Preview command (File menu), 413
 - Print Setup command (File menu), 403
 - Print Setup dialog box, 403
 - Printing
 - barchart views, 404
 - calendars, 403
 - collating, 403
 - copies, 403
 - current display, 408
 - described, 402
 - histogram views, 404
 - margins, 405
 - network views, 404
 - note categories, 405
 - notes, 405
 - on a network, 404
 - paper, 404
 - paper orientation, 404, 405
 - print preview, 413
 - print range, 403
 - print setup, 403
 - printer, 403, 404
 - project start, 409
 - range of data, 408
 - spreadsheet views, 404
 - Time Now, 409
 - title blocks, 410
 - Priority fields, 334
 - Probability distribution shapes
 - asymmetrical, 662
 - defined, 672
 - normal, 670
 - symmetrical, 676
 - triangular, 677
 - uniform, 678
 - Profile curves. *See* Assignment profile curves
 - Progress calculations
 - updating activity status and actual dates, 380
 - Progress Calculations button, 28, 379, 383
 - Progress Calculations command (Tools menu), 379, 383
 - Progress Calculations dialog box, 379
 - Progress cursor, 372
 - Progress information
 - Accomplished Duration field, 372
 - actual finish date, 370
 - actual start date, 370, 373
 - as planned, 370
 - automatic activity progress, 379
 - automatic resource progress, 178, 383, 386
 - baselines, 360
 - calculations, 373
 - complete, 370
 - costs, 375
 - costs based on progress, 179
 - effect on time analysis, 373
 - elapsed duration, 370
 - entering in barchart views, 372
 - entering in spreadsheet views, 371
 - expected finish date, 370

- out of sequence, 373, 671
 - percent complete, 370
 - physical percent complete, 671
 - Progress Type field, 371
 - Progress Value field, 371
 - remaining duration, 370, 673
 - Remaining Duration field, 372
 - resources, 375
 - subprojects, 373
 - Time Now, 369
 - turnaround reports, 369
 - use of actual dates, 369
 - viewing, 372
 - Progress Type field, 371
 - Progress Value field, 371
 - Project
 - startup view, 119
 - Project priority, 126
 - Project Properties command (Project menu), 373
 - Project Properties dialog box
 - Access Control tab, 128
 - Codes tab, 115, 131, 283
 - Cost tab, 115, 123, 260, 417
 - Files tab, 66, 115, 121
 - Notes tab, 115, 125, 184
 - Open Status tab, 110, 115, 129
 - Preferences tab, 115, 118, 232, 633
 - References tab, 130
 - Scheduling tab, 115, 126
 - Security tab, 115
 - Status tab, 115, 122, 372
 - Summary tab, 115, 116, 366
 - User Fields tab, 112, 115, 128
 - Project-level codes, 646
 - Projects
 - access control, 128
 - baselines, 360, 662
 - briefcasing, 600
 - code files, 271
 - computed status, 310
 - creating, 643
 - critical path, 664
 - default, 643
 - default activity type, 118
 - default duration unit, 120, 208
 - defined, 672
 - displaying budget costs, 260
 - early finish date, 122
 - emailing, 621
 - exporting MSP files, 521
 - exporting P3 files, 526
 - exporting XER files, 526
 - foreign activities, 303
 - hierarchies, 289
 - importing and exporting general, 528
 - importing MSP files, 518
 - importing P3 files, 526
 - importing XER files, 526
 - late finish date, 122
 - latest early finish date, 310
 - latest late finish date, 310
 - logic, 672
 - loop detection, 145
 - minimum calculated duration, 120
 - minimum total float, 122, 310
 - notes, 418
 - open status, 110, 130
 - percent complete, 310
 - project priority, 126
 - project-level codes, 646
 - scheduled finish date, 122
 - standard views, 644
 - start date, 122
 - status, 122
 - target finish dates, 122, 676
 - target start dates, 122
 - target total cost, 124
 - target types, 122, 676
 - time analysis calculations, 310
 - Time Now, 122
 - Projects system folder, 52
 - Pull-down menus, 26
 - Punctuated significant coding systems, 96, 265, 267, 672
- ## R
- Radio buttons, 35
 - RBS. *See* Resource breakdown structure
 - Read Only access mode, 61, 85, 95, 633
 - Reduced display mode, 460
 - References
 - assigning references to projects, 131
 - Refresh button, 28, 545, 554
 - Relationship calendars, 119, 233
 - Relationship mode, 147
 - Relationship Mode button, 28, 147, 148
 - Relationship Mode command (View menu), 148
 - Relationship spreadsheet views, 155
 - Relationships
 - adding in barchart views, 147
 - adding in network views, 154
 - adding in spreadsheet views, 157
 - adding using the Activity Details dialog box, 144
 - adding using the Add Relationship command, 145
 - calendars, 230
 - controlling, 435, 462, 664
 - default type, 144, 148
 - defined, 672
 - deleting in network views, 154
 - described, 143
 - direct line style, 463
 - displaying in barchart views, 146, 435
 - duration-driven lags, 144
 - editing in network views, 154
 - finish-to-finish, 144, 148, 666
 - finish-to-start, 144, 148, 666
 - float, 672
 - lag calendars, 144
 - lags, 144, 669
 - mode in barchart views, 147
 - percentage lags, 144
 - predecessors, 671
 - routed line style, 463

Index

- showing lags, 462
- showing types, 462
- smoothing line corners, 462
- start-to-finish, 144, 148, 676
- start-to-start, 144, 148, 676
- successors, 676
- types, 144
- using the split view, 464
- whole, 678
- Relative dates, 429
- Remaining duration, 370, 673
- Remaining Duration field, 372
- Remaining float, 335
- Renaming calendars, 241
- Reporting Calendar field, 417
- Reporting calendars
 - copying, 417
 - creating, 416
 - deleting, 417
 - described, 415
 - editing, 416
 - in date scales, 432
 - selecting, 124
- Reporting Calendars command (Tools menu), 415
- Reporting hammocks. *See* Hammock activities
- Reports. *See* Views
- Reprofiling activities, 324
- Reprofiling activities, 672
- Resize cursor, 153, 442, 444
- Resource assignment spreadsheet views, 216
- Resource breakdown structures, 170
- Resource curve, 119
- Resource Details dialog box
 - Availability tab, 180
 - Code tab, 179, 285
 - described, 174
 - displaying, 174
 - Escalations tab, 182
 - General tab, 175
 - Skills tab, 194
 - User Fields tab, 182
- Resource Display Preferences dialog box
 - Box Layout tab, 197
 - Options tab, 196
- Resource files
 - assigning to projects, 67, 121, 173
 - code files, 271
 - copying, 172
 - creating, 171
 - deleting, 172
 - described, 171
 - icons, 171
 - notes, 418
 - opening, 171
- Resource level, 94, 119
- Resource reservations
 - described, 186
 - effect on Select Resource dialog box, 186
- Resource scheduling
 - activity reprofiling, 672
 - activity reprofiling, 324
 - activity splitting, 323, 675
 - activity stretching, 323, 676
 - calculation of dates, 321
 - defined, 674
 - delaying resource, 665
 - described, 320
 - earliest feasible dates, 665
 - effect of thresholds, 176
 - hard zeros processing option, 181, 333, 667
 - hierarchical priority field, 335
 - immediate activities, 668
 - in-progress priority processing option, 332
 - leveling, 673
 - performing, 328
 - priority fields, 334
 - remaining float, 335
 - reporting, 340
 - reservations, 320
 - resource-limited, 320, 322, 328, 338, 673
 - roll-up, 177
 - scheduling interval, 336
 - session logs, 330
 - smoothing processing option, 333
 - summary resource usage file, 126
 - Time Now, 122, 321
 - time-limited, 320, 322, 328, 338
- Resource Scheduling button, 28, 330
- Resource Scheduling command (Tools menu), 328
- Resource Scheduling dialog box
 - Advanced tab, 332
 - Options tab, 328
- Resource Selection dialog box, 506
- Resource views, 391
- Resource/activity spreadsheet views, 217
- Resource-limited resource scheduling, 320, 322, 328, 338, 673
- Resources
 - actual cost based on progress, 179
 - actual quantity, 377
 - adding, 188
 - all resource categories, 214
 - allocation, 220, 673
 - alternate, 208, 220, 661
 - assigning resources in spreadsheet views, 216
 - assignment levels, 208, 673
 - assignment offsets, 208, 673
 - assignment periods, 209, 673
 - assignment profile curves, 207, 662
 - assignment totals, 674
 - assignments, 205, 673
 - automatic progressing, 178, 383, 386
 - availabilities, 180, 673
 - availability dates, 180
 - availability of consumable resources, 181
 - availability of perishable resources, 181
 - breakdown structures, 170, 673
 - budgeted, 375
 - calculating actual costs, 256, 258
 - calculating budget costs, 253
 - calendars, 230
 - categories, 177, 214, 506
 - consider in cost calculations, 179
 - consumable, 176, 664

- cost escalations, 182, 666
 - custom box text, 197
 - default resource curve, 119
 - default resource level, 94, 119
 - defined, 673
 - defining assignment profile curves, 226
 - delaying, 665
 - described, 170
 - displaying in histogram views, 499
 - displaying resource information, 196
 - effort factor, 177
 - expanding all pools, 190
 - expanding pools, 190
 - hard zeros processing option, 181, 333, 667
 - hierarchies, 170, 667
 - ID, 175
 - interpreting zero availabilities, 181
 - labor, 214, 668
 - level assignments, 207
 - leveling, 320
 - locking, 220, 222, 224
 - material, 214
 - moving in hierarchy, 189
 - normal, 176
 - notes, 418
 - other direct costs, 214
 - perishable, 176, 671
 - pools, 170, 176, 220, 674
 - progressing, 375
 - project, 176
 - Properties dialog box, 233
 - remaining quantity, 377
 - requested, 220, 673
 - reserving a portion of a resource, 186
 - reserving a resource completely, 186
 - reserving for projects, 186, 320
 - roll up for scheduling, 177
 - selecting, 42, 212, 336
 - selecting for histogram views, 506
 - skill filter, 213
 - skills, 192, 220
 - soft zeros, 181
 - subcontract, 214
 - suggested, 220
 - suppress for scheduling, 177
 - suppress in lists, 177
 - thresholds, 176, 674, 677
 - total assignments, 207
 - types, 176
 - unbudgeted, 375
 - unit costs, 176
 - unit descriptions, 176
 - Restore command, 595
 - Restore File command (File→Manage Files submenu), 600
 - Restore Target Exists dialog box, 597
 - Restore Wizard
 - Details page, 597
 - Restore page, 595
 - Restoring files, 595
 - Risk analysis
 - compared to time analysis, 349
 - criticality index, 349, 354
 - defined, 674
 - described, 345
 - distribution shapes, 346
 - fixed seed point, 350
 - histogram views, 355
 - key activities, 348
 - mode durations, 347
 - Monte Carlo simulations, 670
 - options, 349
 - session log, 349
 - simulations, 350
 - spreadsheet views, 353
 - standard deviations, 353
 - Risk Analysis button, 29, 349, 351
 - Risk Analysis command (Tools menu), 351
 - Risk Analysis dialog box, 349
 - Advanced tab, 351
 - Options tab, 349
 - Risk Analysis Preferences dialog box, 513
- ## S
- Save As command (File menu), 64, 172, 231, 270, 292
 - Save As dialog box, 64
 - Save button, 28, 64
 - Save command (File menu), 64
 - Save Options dialog box, 522
 - Save Project dialog box, 521
 - Save View command (File menu), 393, 448
 - Saving
 - automatic placements, 456
 - files, 64
 - views, 393, 394
 - Scaling Specification dialog box, 458
 - Schedule performance index, 261
 - Schedule variances, 249, 261, 674
 - Scheduled dates, 321, 674
 - Scheduled durations, 321, 674
 - Scheduled finish dates
 - activities, 321, 674
 - projects, 122
 - Scheduled float, 674
 - Scheduled start dates, 321, 675
 - Scheduling interval, 336
 - S-curves. *See* Histogram views
 - Search For Help On command (Help menu), 18
 - Searching. *See* Finding
 - Security Administrator, 14
 - Security features
 - access rights, 364, 616
 - baselines, 365
 - described, 616
 - Group field, 109, 129, 616
 - Owner field, 109, 129, 616
 - owners, 364, 616
 - Read Only field, 109, 129, 617
 - Role field, 109, 129, 616
 - Security Administrator, 14
 - User ID field, 109, 129, 617
 - user passwords, 617
 - Select Activity command (View menu), 513

Index

- Select All command (Edit menu), 41
- Select Code dialog box, 131, 284
- Select dialog box, 67, 88, 292
- Select File to Delete dialog box, 70, 172, 593
- Select MSP Project dialog box, 518
- Select MSP Version dialog box, 524
- Select Note Categories dialog box, 405, 422
- Select P3 Project dialog box, 526
- Select Project or Project Database dialog box, 518
- Select Resource command (View menu), 507
- Select Resource dialog box, 212
- Select Standard Views dialog box, 644
- Selecting
 - activities in network views, 41
 - activities in spreadsheet views, 41
 - codes, 42
 - data, 40
 - files, 67, 88
 - icons, 40
 - items in a list, 40
 - resources, 42, 212
 - resources for resource scheduling, 336
 - techniques, 40
 - text, 40
- Selection button, 41
- Send command (File menu), 621
- Session logs
 - automatic activity progressing, 382
 - automatic resource progressing, 384
 - resource scheduling, 330
 - risk analysis, 349
 - time analysis, 311
- Shared access mode, 61, 85, 95, 632
- Sheets. *See* Spreadsheet views
- Shifts. *See* Calendars
- Size command (Control menu), 34
- Skills
 - assigning to resources, 194
 - defining, 193
 - deleting, 194
 - described, 192
 - managing, 192
 - skill ID, 193
 - unit cost, 193
- Smoothing processing option, 333, 675
- Snapshot button, 29
- Soft zeros, 181
- Sort Expression dialog box, 555
 - access control, 556
 - references, 556
- Sorts
 - adding, 556
 - clicking to sort a column, 560
 - copying, 557
 - default sort order rules, 553
 - defining, 555
 - deleting, 557
 - described, 553
 - editing, 556
 - effect on outlining, 484
 - expressions, 555
 - refreshing, 554
 - temporary sorts, 557
 - using, 554
- Sorts command (Tools menu), 554
- Sorts dialog box, 554
- Spell checking
 - custom dictionaries, 624
 - described, 624
 - dictionaries, 625
 - email advisories, 590, 624
 - notes, 624
 - options, 624
- SPI. *See* Schedule performance index
- Split view cursor, 464, 474
- Splitting
 - network views, 464
 - splitter control, 464, 474
 - spreadsheet views, 474
- Splitting activities, 323, 675
- Spread curves. *See* Assignment profile curves
- Spreadsheet Preferences dialog box
 - Define Links tab, 488
 - Options tab, 475, 477, 481
 - Outlining tab, 485
 - Subsections tab, 481
- Spreadsheet views
 - activity spreadsheets, 155, 286
 - activity/resource spreadsheets, 216
 - adding child activities, 297
 - adding columns, 472
 - changing column headings, 473
 - changing data tables, 477
 - changing grid line color, 475
 - clicking to sort, 560
 - copying activities, 44
 - customizing, 470
 - cutting activities, 44
 - defined, 391, 675
 - defining links, 488
 - defining subsections, 481
 - defining temporary calculated fields, 564
 - deleting columns, 473
 - described, 469
 - disabling subsections and outlining, 476
 - display options, 475
 - displaying grid lines, 475
 - displaying subprojects, 297
 - displaying temporary filters, 550
 - enabling outlining, 476
 - enabling subsections, 476, 481
 - filling columns down, 473
 - formatting, 471
 - grand totals, 479
 - icons, 469
 - including line numbers, 406
 - indenting, 491
 - inserting columns, 472
 - keyboard shortcuts, 150
 - linking, 488
 - multi-table, 469, 488
 - outdenting, 491
 - outlining, 484
 - pasting activities, 45

- predecessor/successor spreadsheets, 156
 - printing, 404
 - resource assignment spreadsheets, 216
 - resource/activity spreadsheets, 217, 488
 - risk, 353
 - showing skills as resources, 476
 - splitting, 474
 - subsection headings, 479
 - subsections, 479, 676
 - summary lines, 479
 - supporting all tables, 477
 - table name, 471, 475
 - Table Name option, 477
 - text format, 471
 - title blocks, 410
 - wrapping text, 471
 - Stacked histograms, 507
 - Standard deviation, 353, 675
 - Standard work week, 236, 675
 - Start activities, 309, 675
 - Start Day of Week setting, 242
 - Start milestone activities, 139, 675
 - Start Month of Year setting, 242
 - Start/finish activities, 309
 - Start-to-finish relationships, 144, 148, 676
 - Start-to-start relationships, 144, 148, 676
 - Start-up Clip Notes, 640
 - Startup folder, 69
 - Startup system folder, 54
 - Startup view, 119
 - Status date. *See* Time Now
 - Status information. *See* Progress information
 - Stay-on-top help, 17
 - Stretching activities, 323, 676
 - Subcontract resources, 214
 - Subheadings. *See* Subsections
 - Submenus, 27
 - Subprojects
 - activity type, 139
 - adding child activities in network views, 295
 - adding child activities in spreadsheet views, 297
 - auxiliary data files, 302
 - closed external, 302
 - converting external to internal, 292, 303
 - described, 289
 - displaying in network views, 293, 448
 - displaying in spreadsheet views, 297
 - drawing relationships in network views, 448
 - drilling down in network views, 293
 - effect on activity information, 290
 - effect on time analysis calculations, 302
 - expanding in network views, 293
 - external, 301, 666
 - foreign activities, 303
 - internal, 290, 668
 - navigation in network views, 293
 - progress information, 373
 - relationships, 290
 - target dates, 290
 - time analysis calculations, 310
 - Subsections
 - defined, 676
 - defining, 481
 - described, 479
 - enabling, 481
 - grand totals, 479
 - headings, 479
 - summary lines, 479
 - Subtotals. *See* Subsections
 - Successor activities, 676
 - Summary resource usage file
 - creating, 126
 - deleting, 127
 - described, 126
 - Support for all tables
 - changing data tables, 477
 - Table Name option, 477
 - Suppressed resources, 177
 - SV. *See* Schedule variance
 - Symbols, 399, 641
 - Symmetrical distributions, 676
 - System Folders
 - Briefcase, 52
 - custom folders, 51
 - My Folder, 51
 - Open Plan Library, 52
 - Projects, 52
 - Startup, 54
 - Users, 52
 - System options
 - custom colors, 648
 - default open mode, 641
 - default start up view, 644
 - default work day, 640
 - displaying the Status Bar, 640
 - displaying the Toolbar, 640
 - language, 641
 - opening last file on startup, 641
 - selecting standard views, 644
 - showing process logs, 643
 - start up tips, 640
 - starting day of the week, 641
 - System Preferences Defaults dialog box, 650
 - theme colors, 647, 648
 - user-defined options, 649, 650
 - System utilities, 585
- ## T
- Tabbed dialog boxes, 36
 - Tabular reports. *See* Spreadsheet views
 - Target dates
 - assigning to activities, 140
 - defined, 676
 - effect of, 123
 - Fixed Target, 140
 - Not Earlier Than, 123, 140
 - Not Later Than, 123, 140
 - On Target, 123, 140
 - project finish dates, 122
 - project start dates, 122
 - setting in barchart views, 147
 - types, 122, 140
 - Target finish dates, 122, 312, 676

Index

- Target Start cursor, 148
 - Target start dates, 676
 - Target types, 122, 140, 312, 676
 - Tasks. *See* Activities
 - Temporary calculated fields, 564
 - Temporary fields, 564
 - Temporary filters
 - defining, 550
 - described, 550
 - displaying in barchart views, 550
 - displaying in network views, 550
 - displaying in spreadsheet views, 550
 - in email advisories, 590
 - in export scripts, 552
 - in OLE automation, 552
 - on secondary tables, 551
 - Temporary Sort Expression dialog box, 557
 - Temporary sorts
 - defining, 558
 - described, 557
 - on secondary tables, 559
 - Text boxes, 35
 - Thresholds, 176, 677
 - Tile command (Window menu), 34
 - Time analysis
 - actual date option, 313
 - automatic time analysis, 315
 - backward pass, 308, 662
 - calculation of dates, 308
 - defined, 677
 - described, 308
 - early dates, 665
 - effect of progress information, 373
 - float calculations, 308
 - forward pass, 308, 667
 - free float, 309, 667
 - loops, 669
 - minimum calculated duration, 120
 - multiple ends processing option, 313, 670
 - operations, 311
 - options, 311
 - out-of-sequence options, 313
 - session log, 311
 - target date types, 312
 - target finish dates, 312
 - Time Now, 122, 308, 312
 - total float, 308, 677
 - Time Analysis button, 28, 314
 - Time Analysis Button, 311
 - Time Analysis command (Tools menu), 314
 - Time Analysis dialog box, 311
 - Time Now, 122, 312, 321, 369, 409, 436, 677
 - Time-limited resource scheduling, 320, 322, 328, 338
 - Time-scaling, 458
 - Tip of the Day, 640
 - Title Block Definition dialog box, 411
 - access control, 412
 - references, 413
 - Title blocks
 - copying, 411
 - creating, 411
 - editing, 411
 - in email advisories, 588
 - Title Blocks command (Tools menu), 413
 - Title Blocks dialog box, 410
 - Toolbar, 27
 - Total float, 308, 677
 - Triangular distribution shape, 347
 - Turnaround reports, 369
- ## U
- Uniform distribution shape, 347
 - Uniform Resource Locator, 626
 - Update Baseline dialog box, 364
 - Update Relationship cursor, 154
 - URL. *See* Uniform Resource Locator
 - User defined fields
 - copying, 578
 - creating, 578
 - creating for baselines, 577
 - data types, 577
 - deleting, 579
 - described, 576
 - editing, 579
 - User Defined Fields command (Tools menu), 576
 - User Defined Fields dialog box, 576
 - User passwords, 617
 - Users system folder, 52
- ## V
- VAC. *See* Variance at complete
 - Variance at complete, 261
 - Variances
 - cost, 249
 - defined, 678
 - schedule, 249
 - Views
 - adding standard views, 645
 - assigning to projects, 68, 393
 - bar sets, 114
 - barchart, 391
 - calculated fields, 561
 - code, 391
 - creating report batches, 627
 - creating templates, 393
 - deleting report batches, 629
 - displaying baseline information, 367
 - emailing, 621
 - filters, 114, 544
 - for new projects, 644
 - histogram, 391
 - modifying templates, 393
 - network, 391
 - opening, 393
 - previewing report batches, 629
 - printing reports, 402
 - publishing on the Web, 626
 - removing from projects, 394
 - removing standard views, 645
 - resource, 391
 - running report batches, 629
 - saving, 393, 394

- sorts, 114, 553
- spreadsheet, 391
- title blocks, 114
- updating report batches, 629
- user defined fields, 576

W

- WBS. *See* Work breakdown structure
- Web Publisher. *See* Open Plan Web Publisher
- Web Publisher command (Tools menu), 627
- Whole relationships, 678
- Window menu, 33
- Windows
 - arranging, 34
 - closing, 34
 - in Open Plan, 33
 - maximizing, 34
 - minimizing, 34

- moving, 34
- resizing, 34
- Work breakdown structure, 136, 678
- Work shifts. *See* Calendars
- Working days, 232, 678
- Working times, 230

Z

- Zero availabilities, 181
- Zone Attributes dialog box, 456
- Zoning, 456, 678
- Zoning headers, 457
- Zoom cursor, 414
- Zoom In button, 28, 200, 282, 461
- Zoom In command (View menu), 200, 281, 460
- Zoom Out button, 29, 200, 282, 461
- Zoom Out command (View menu), 199, 281, 460